

NANOTECH
TECHNOLOGY | PERCISION | SATISTACTION

06

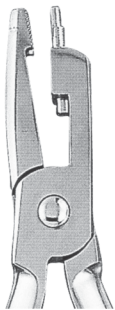

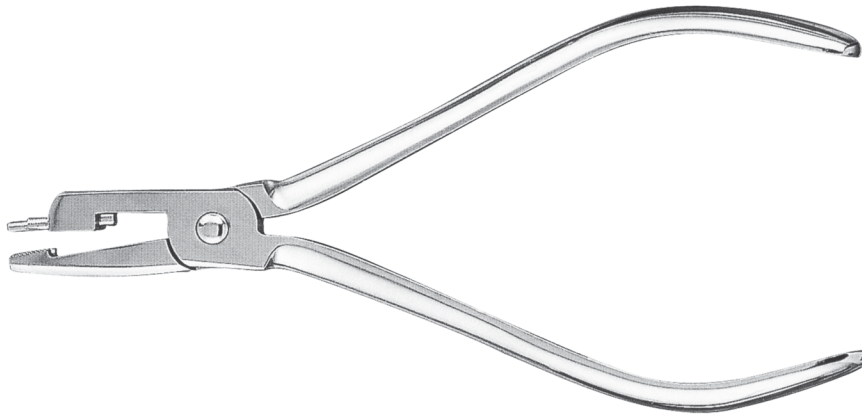

06-0001-00



06-0002-00

TC

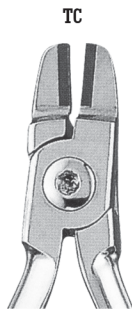

06-0003-00

TC



06-0004-00



06-0005-00



06-0006-00



06-0007-00

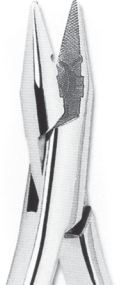

06-0008-00



06-0009-00

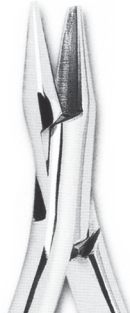

06-0010-00

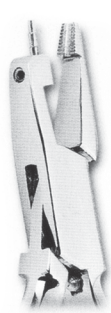

06-0011-00

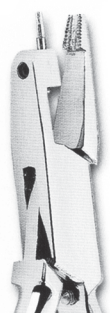

06-0012-00

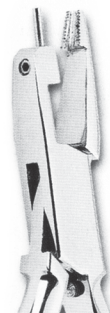

06-0013-00



06-0014-00

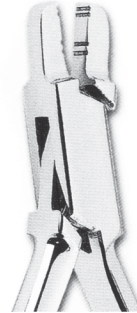

06-0015-00



06-0016-00



06-0017-00



06-0018-00



06-0019-00



06-0020-00

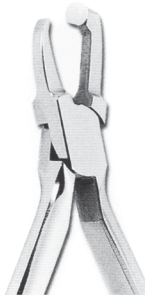

06-0021-00



06-0022-00



06-0023-00

TC



06-0024-00

TC

ORTHODONTIC PLIERS AND WIRE CUTTERS



06-0025-00

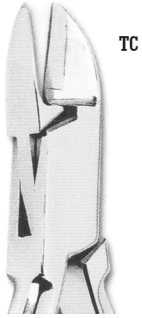

06-0026-00



06-0027-00



06-0028-00



06-0029-00



06-0030-00



06-0031-00



06-0032-00

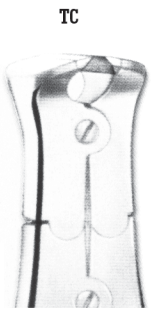

06-0033-00



06-0034-00



06-0035-00

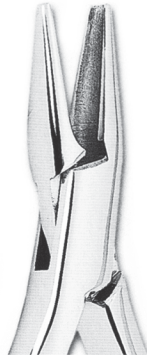

06-0036-00



06-0037-00



06-0038-00



06-0039-00



06-0040-00



06-0041-00



06-0042-00



06-0043-00



06-0044-00



06-0045-00



06-0046-00



06-0047-00



06-0048-00

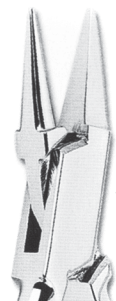

06-0049-00



06-0050-00

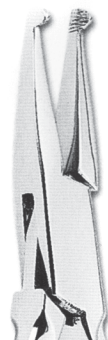

06-0051-00



06-0052-00



06-0053-00



06-0054-00

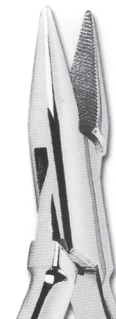

06-0055-00

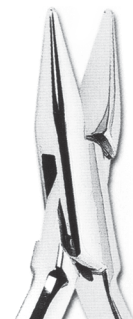

06-0056-00



06-0057-15
15cm



BOHM
06-0058-115 11.5cm
06-0059-145 14.5cm

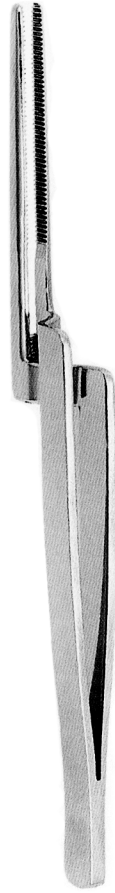

06-0060-15
MILLER
15cm



06-0061-15
MILLER
15cm



06-0062-15
15cm



06-0063-14
MERSHON
14cm

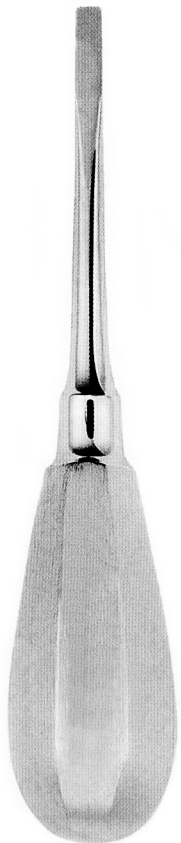

06-0064-00
FIG.0

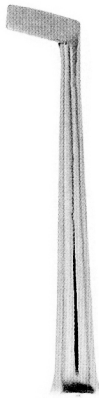

06-0065-1
FIG.1

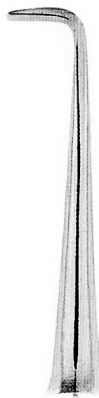

06-0066-2
FIG.2

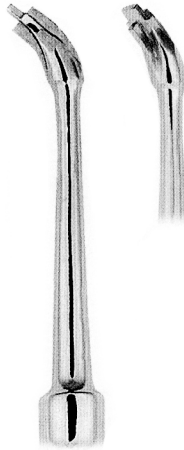

06-0067-3
FIG.3
(UNIVERSAL)

06-0068-5
FIG.5 (5mm)
IVORY 8



06-0069-6
FIG.6 (6mm)
IVORY 8



06-0070-7
FIG.7 (7mm)
IVORY 8



06-0071-8N
FIG.8N
IVORY 8N

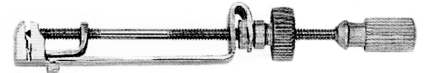

06-0072-8P
FIG.8P
DIDNER 8P



06-0073-1
FIG.1
TOFFLEMIRE-UNIVERSAL

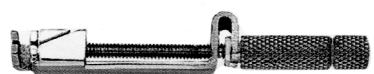

06-0074-2
FIG.2
TOFFLEMIRE-JUNIOR

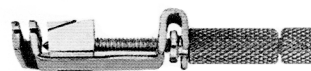

06-0075-3
FIG.3
TOFFLEMIRE-SENIOR

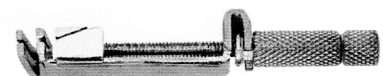

BONE RONGEURS AND MALLETS

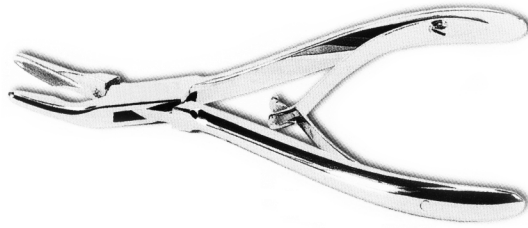

06-0076-15
LUER
15cm



06-0077-14
FRIEDMAN
14cm



06-0078-12
MINI-FRIEDMAN
12cm



06-0079-10
GOLDMAN-FOX
10cm



06-0080-15
BLUMENTHAL
15cm



06-0081-145
BLUMENTHAL
45°
14.5cm



06-0082-14
BLUMENTHAL
90°
14cm



06-0083-165
MEAD-1A
16.5cm



06-0084-165
CLEVELAND-5
16.5cm



06-0085-165
CLEVELAND-GARDNER
16.5cm

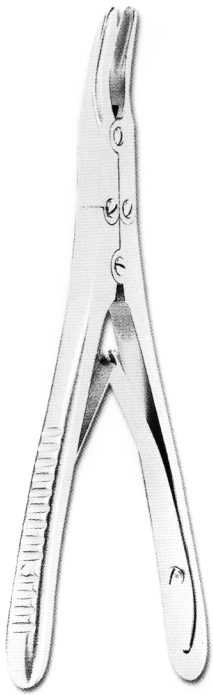

06-0086-18
BEYER
18cm



06-0087-155
RUSKIN-MINI
15.5cm



06-0088-15
BOHLER
15cm



06-0089-15 To 06-0091-15
KERRISON
15cm

06-0089-15
2mm

06-0090-15
3mm

06-0091-15
5mm

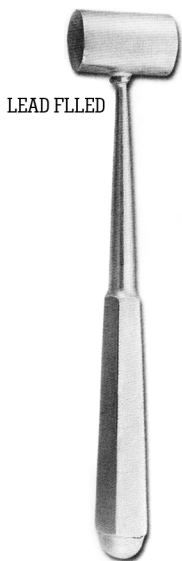

LEAD FILLED

06-0092-19
PARTSCH
19cm



NON AUTOCLAVEABLE
PLASTIC HEADS

06-0093-195
MEAD
19.5cm



Ø26mm

06-0094-17
MEAD
17cm



06-0095-19
VICKERS
19cm



06-0096-19
HERBERT
19cm



06-0097-1
 FIG.1
 POLOKOFF



06-0098-33
 FIG.33



06-0099-45
 FIG.45
 MILLER

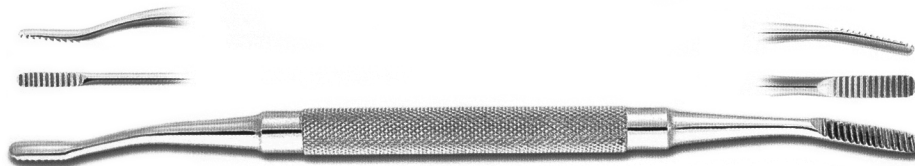

06-0100-64
 FIG.64
 MILLER

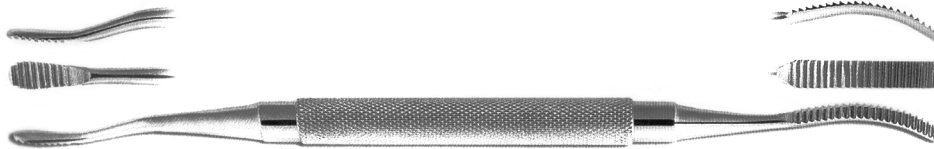

06-0101-10
 FIG.10

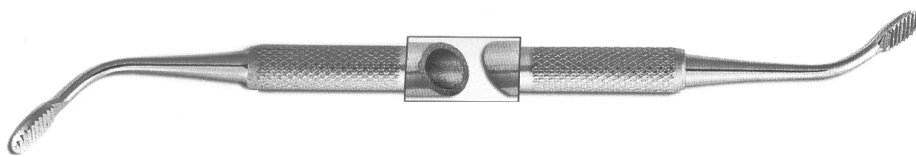

06-0102-1
 FIG.1
 WAHL

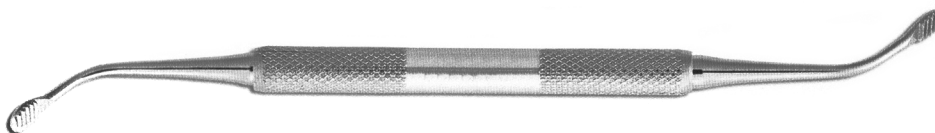

06-0103-2
 FIG.2
 WAHL

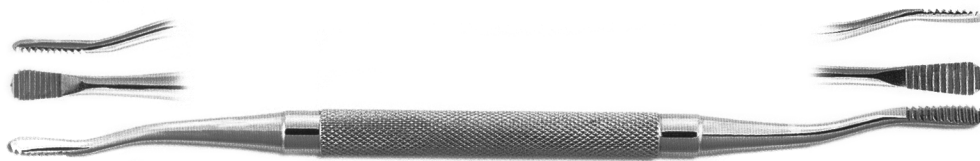

06-0104-12
 FIG.12
 HOWARD

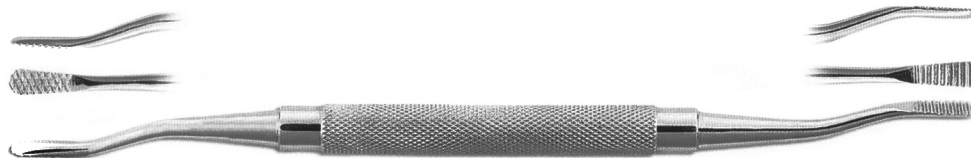

06-0105-12A
 FIG.12A



06-0106-12CA
 FIG.12CA

PERIODONTAL INSTRUMENTS

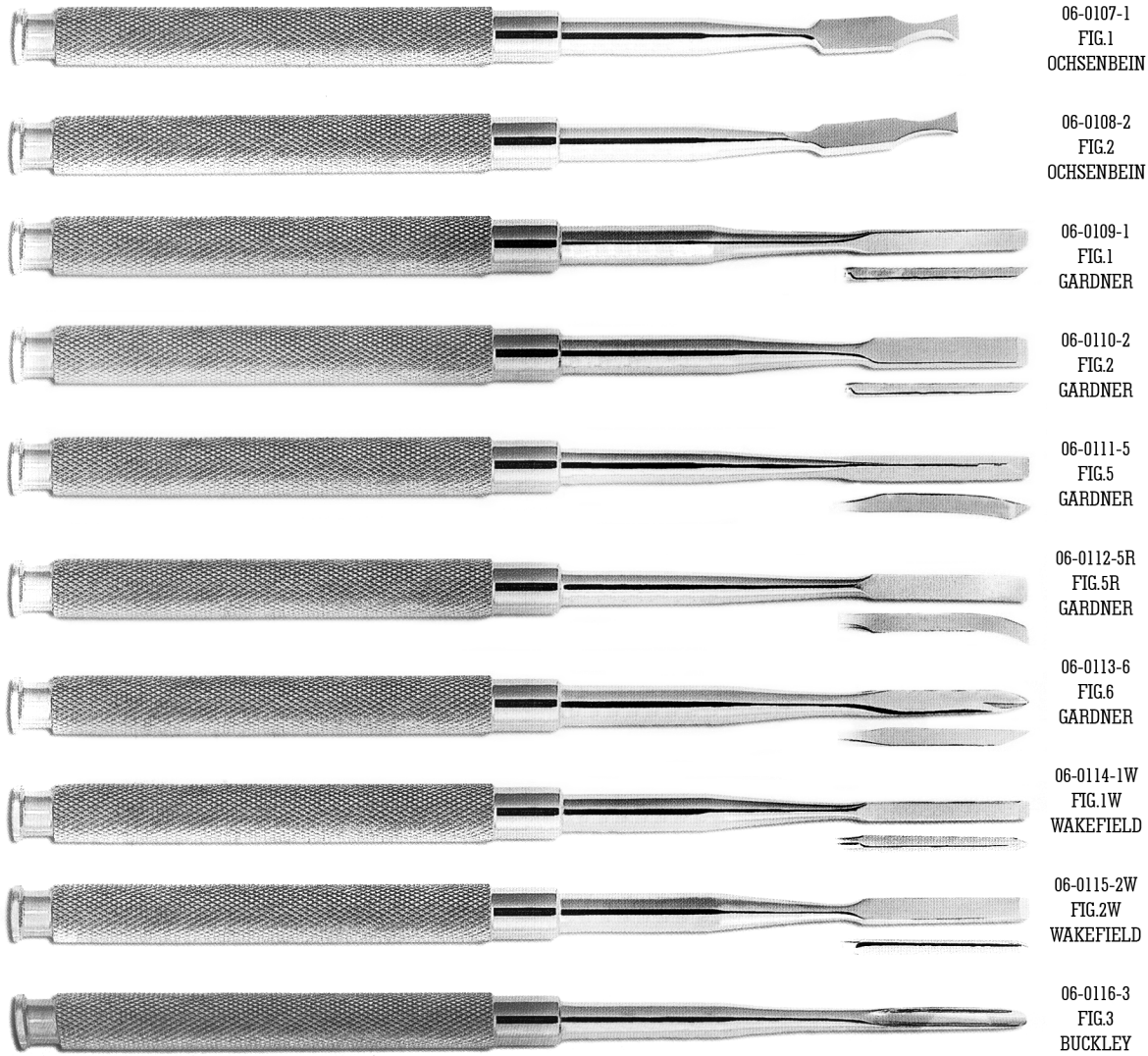

06-0117-135 To 06-0120-135
PARTSCH
13.5cm

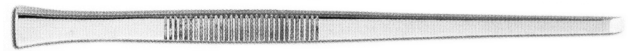

06-0121-17 To 06-0124-17
PARTSCH
17cm

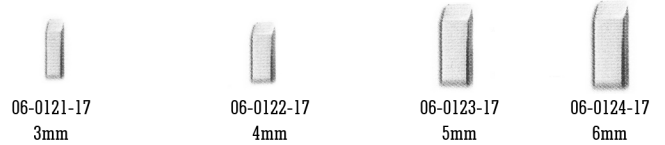







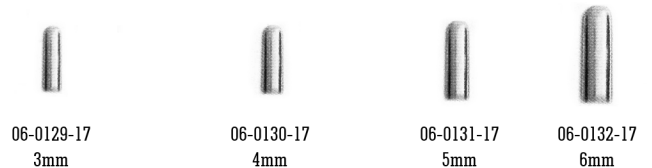
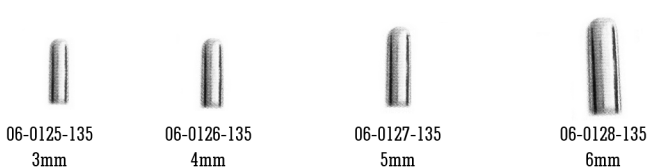









06-0125-135 To 06-0128-135
PARTSCH
13.5cm

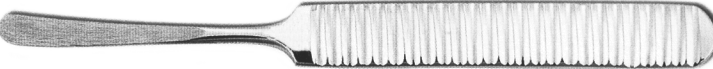
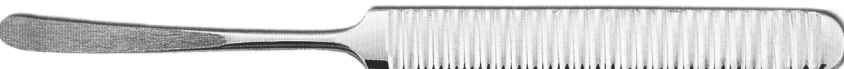

06-0129-17 To 06-0132-17
PARTSCH
17cm

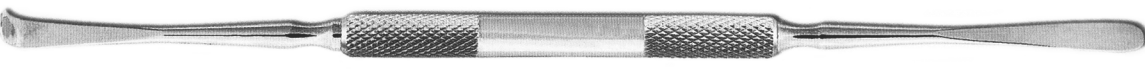
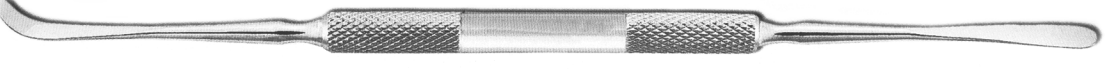

	06-0133-GF FIG.GF GOLDMAN-FOX
	06-0134-M9 FIG.M9 MOLT
	06-0135-M8 FIG.M8 MOLT
	06-0136-M7 FIG.M7 MOLT
	06-0137-9A FIG.9A ALLEN
	06-0138-2 FIG.2 HOURIGAN
	06-0139-PR3 FIG.PR3 PRICHARD
	06-0140-1 FIG.1 HOPKINS
	06-0141-2 FIG.2 HOPKINS
	06-0142-3 FIG.3 MEAD
	06-0143-00 BEALE
	06-0144-13 WILLIGER 13cm
	06-0145-16 WILLIGER 16cm
	06-0146-16 WILLIGER 16cm
	06-0147-17 WILLIGER 17cm
	06-0148-23 FIG.23 SELDIN
	06-0149-22 FIG.22 SELDIN
	06-0150-145 PARTSCH 14.5cm
	06-0151-155 KONIG 15.5cm
	06-0152-16 FIG.16 (FREER) 20 cm
	06-0153-15 FIG.15 (FREER) 20 cm

SPATULAS, ELEVATORS AND ORTHODONTICS

SEPERATING SPATULAS

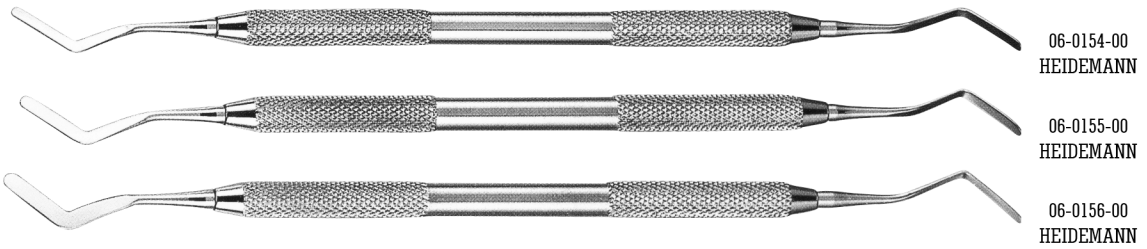

PERIOSTEAL ELEVATORS

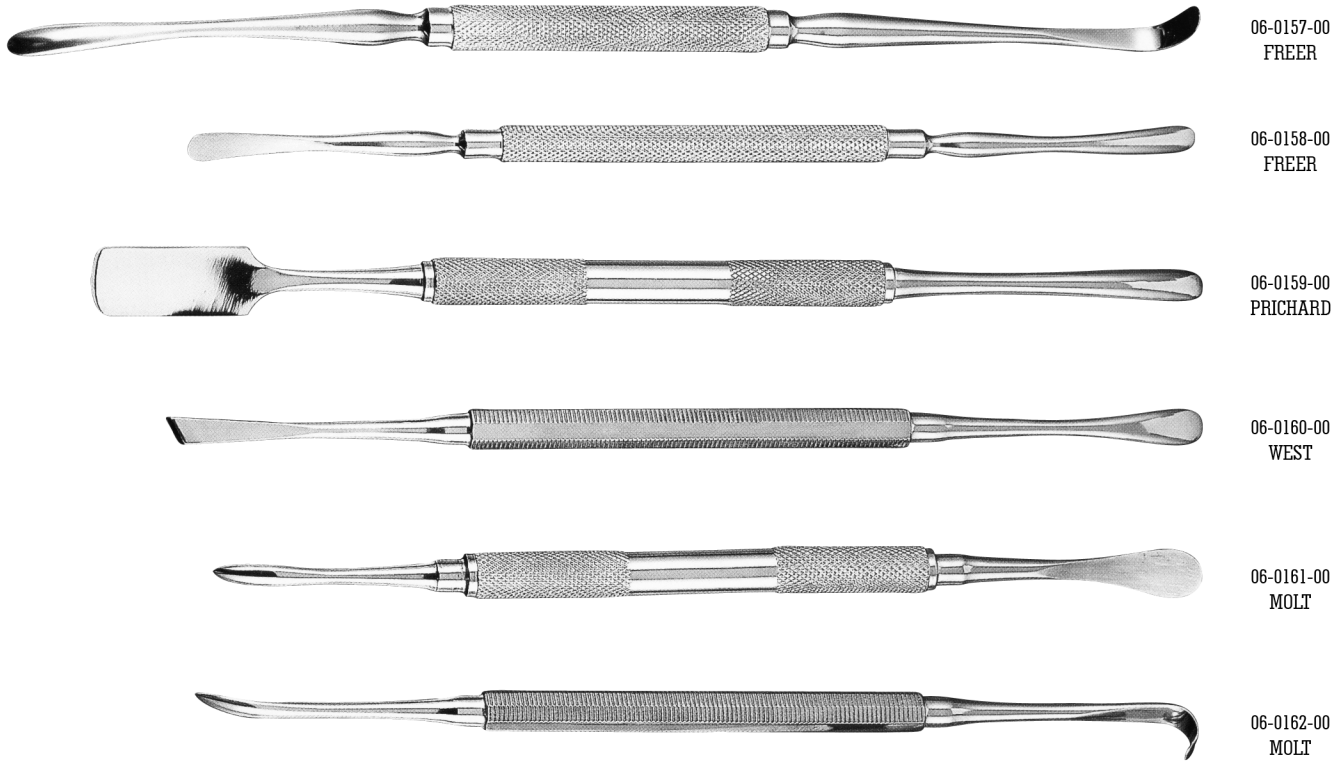

ORTHODONTICS

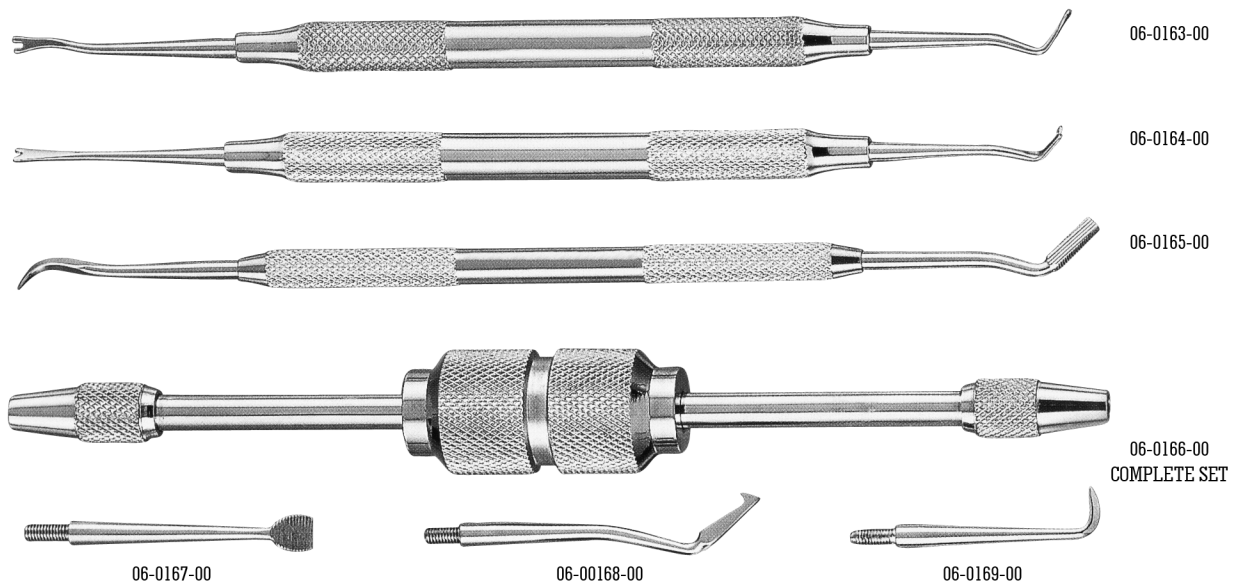

ALL ABOVE PRODUCTS ARE ALSO AVAILABLE WITH HOLLOW HANDLES

ALL ELEVATORS ARE AVAILABLE WITH HANDLE "A", HANDLE "B" AND HANDLE "C"

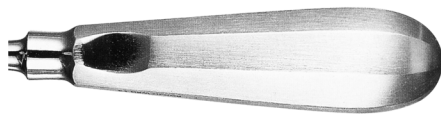

HANDLE "A"

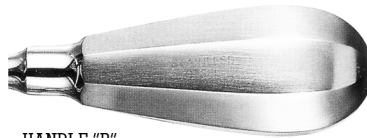

HANDLE "B"

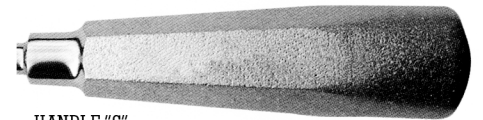

HANDLE "C"

 2 mm	 3 mm	 3.7 mm	 3 mm	 3.7 mm	 4.3 mm	 2 mm	 3 mm	 4 mm
06-0170-1 FIG. 1 (BEIN)	06-0171-2 FIG. 2 (BEIN)	06-0172-3 FIG. 3 (BEIN)	06-0173-4 FIG. 4 (BEIN)	06-0174-5 FIG. 5 (BEIN)	06-0175-6 FIG. 6 (BEIN)	06-0176-00 FIG. (BEIN)	06-0177-1B FIG. 1B (BEIN)	06-0178-2B FIG. 2B (BEIN)
 3 mm	 4 mm	 3.5 mm		 3.5 mm				
06-0179-1F FIG. 1F (FLOHR)	06-0180-00 FIG. (FLOHR)	06-0181-2 FIG. 2 (FLOHR)	06-0182-3 FIG. 3 (FLOHR)	06-0183-00 (FLOHR)	06-0184-00 (FLOHR)	06-0185-00 (SELDIN)	06-0186-34 FIG. 34 (SELDIN)	06-0187-34S FIG. 34S (SELDIN)
06-0188-25 FIG. 25 (SELDIN)	06-0189-00 (SELDIN)	06-0190-1L FIG. 1L (SELDIN)	06-0191-1R FIG. 1R (SELDIN)	06-0192-4L FIG. 4L (SELDIN)	06-0193-4R FIG. 4R (SELDIN)	06-0194-26 FIG. 26 (CRYER)	06-0195-25 FIG. 25 (CRYER)	06-0196-45 FIG. 45 (CRYER)
06-0197-44 FIG. 44 (CRYER)	06-0198-12 FIG. 12 (CRYER)	06-0199-00 (CRANE PICK)	06-0200-00 (WHITE)	06-0201-00 (APICAL)	06-0202-00 (APICAL)	06-0203-00 (APICAL)	06-0204-00 (APICAL)	

ALL ELEVATORS ARE AVAILABLE WITH HANDLE "A", HANDLE "B" AND HANDLE "C"



06-0205-71 FIG. 71 (MILLER APEXO) 06-0206-72 FIG. 72 (MILLER APEXO) 06-0207-73 FIG. 73 (MILLER APEXO) 06-0208-74 FIG. (MILLER APEXO) 06-0209-00 (KOPP) 06-0210-00 (KOPP) 06-0211-00 (KOPP) 06-0212-00 (KOPP)

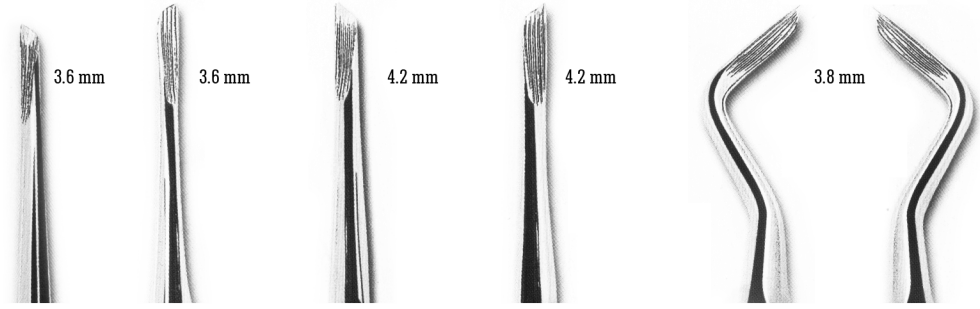

06-0213-1K FIG. 1K (KOPP) 06-0214-2K FIG. 2K (KOPP) 06-0215-3K FIG. 3K (KOPP) 06-0216-4K FIG. 4K (KOPP) 06-0217-5K FIG. 5K (KOPP) 06-0218-6K FIG. 6K (KOPP)

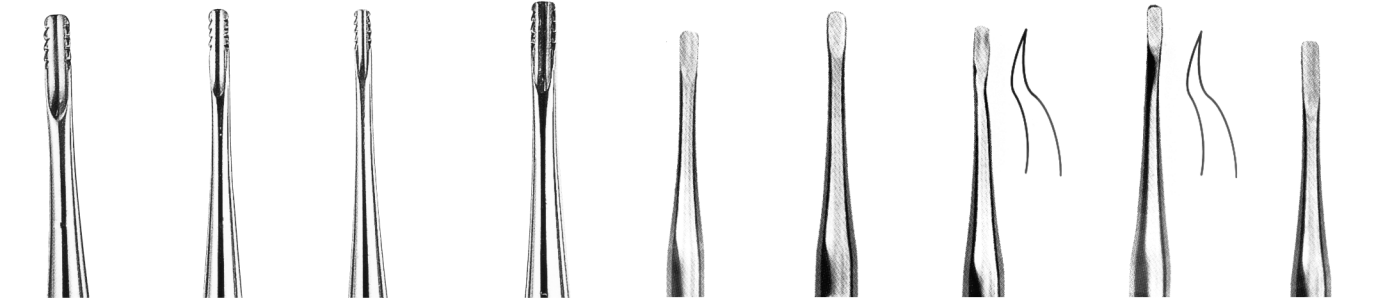

06-0219-00 (LINDO-LEVIEN) 06-0220-00 (LINDO-LEVIEN) 06-0221-00 (LINDO-LEVIEN) 06-0222-00 (LINDO-LEVIEN) 06-0223-00 (LINDO-LEVIEN) 06-0224-00 (LINDO-LEVIEN) 06-0225-00 (LINDO-LEVIEN) 06-0226-00 (LINDO-LEVIEN) 06-0227-00 (LINDO-LEVIEN)

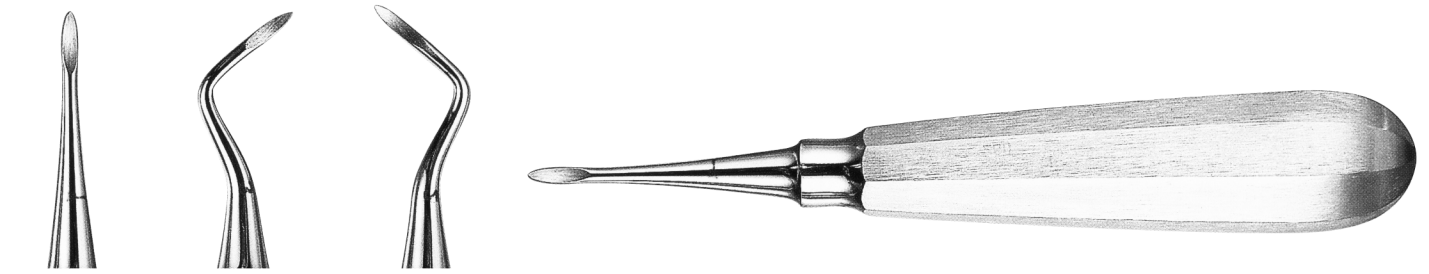

06-0228-1 FIG. 1 (HEIDEBRINK) 06-0229-2 FIG. 2 (HEIDEBRINK) 06-0230-3 FIG. 3 (HEIDEBRINK)

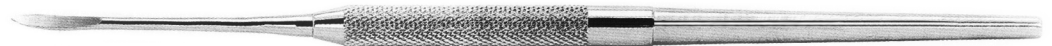
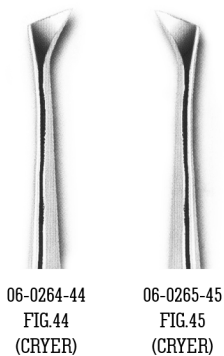
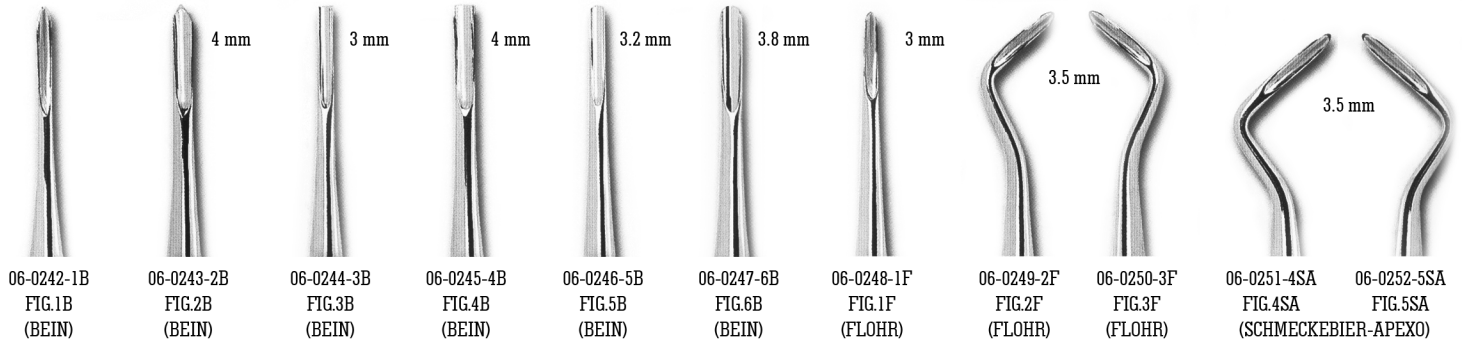
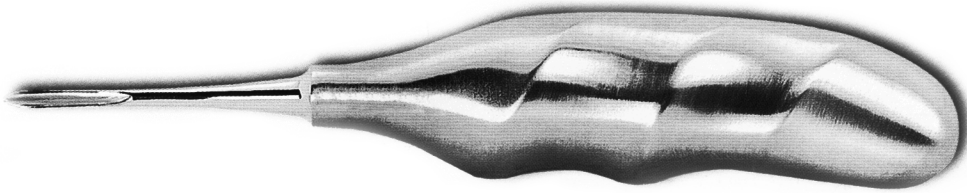
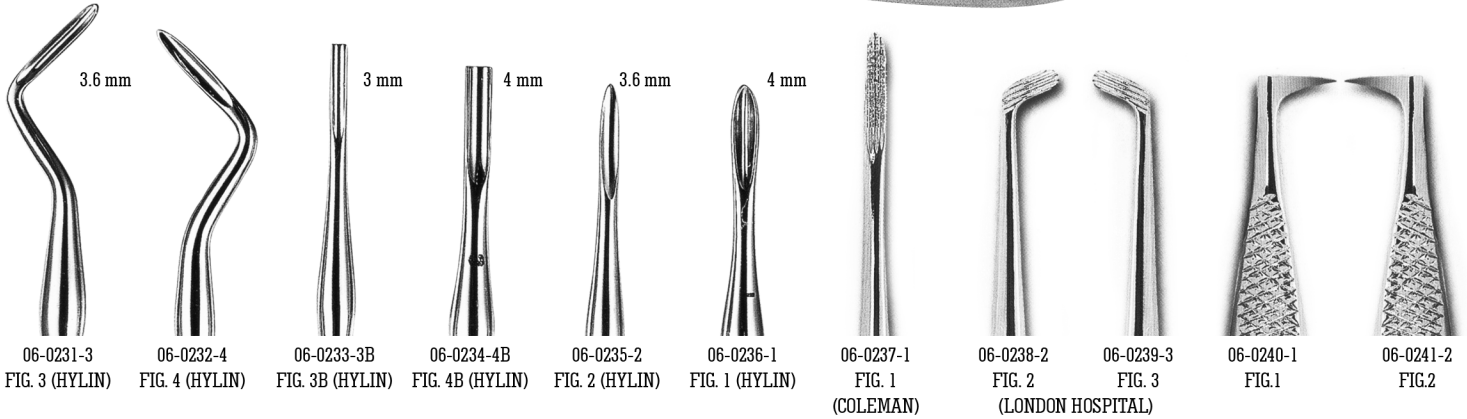
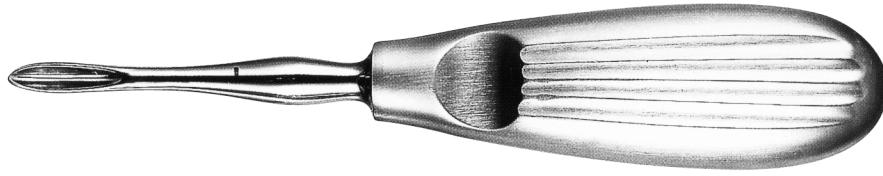

ROOT ELEVATORS



06-0269-00
(LINDO-LEVIEN)

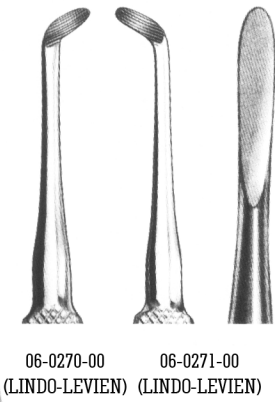

06-0270-00 (LINDO-LEVIEN) 06-0271-00 (LINDO-LEVIEN)



06-0272-00
(LINDO-LEVIEN)

06-0273-00 (LINDO-LEVIEN) 06-0274-00 (LINDO-LEVIEN)

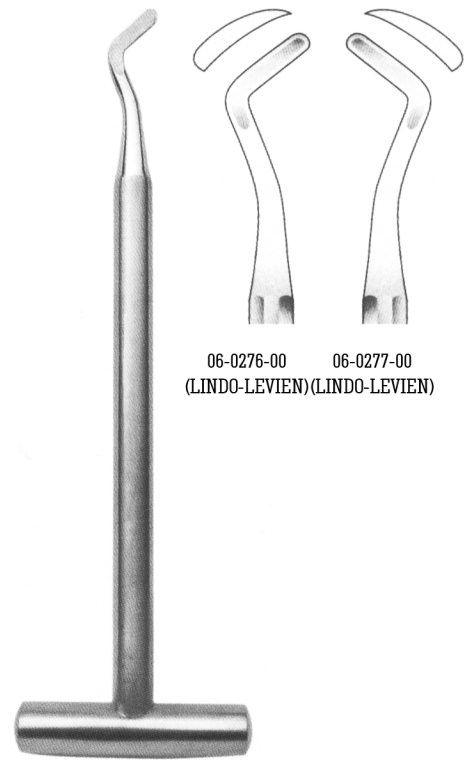

06-0275-00
(LINDO-LEVIEN)

06-0276-00 (LINDO-LEVIEN) 06-0277-00 (LINDO-LEVIEN)



06-0278-00
(LINDO-LEVIEN)

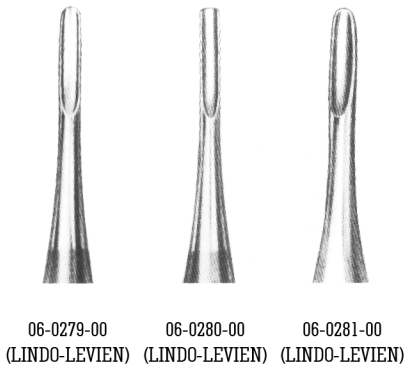

06-0279-00 (LINDO-LEVIEN) 06-0280-00 (LINDO-LEVIEN) 06-0281-00 (LINDO-LEVIEN)



06-0282-00 (LINDO-LEVIEN) 06-0283-00 (LINDO-LEVIEN)



06-0284-00
(LINDO-LEVIEN)

06-0285-00
(LINDO-LEVIEN)



06-0286-00
(LINDO-LEVIEN)



06-0287-00
(LINDO-LEVIEN)

WALTER F. BARRY

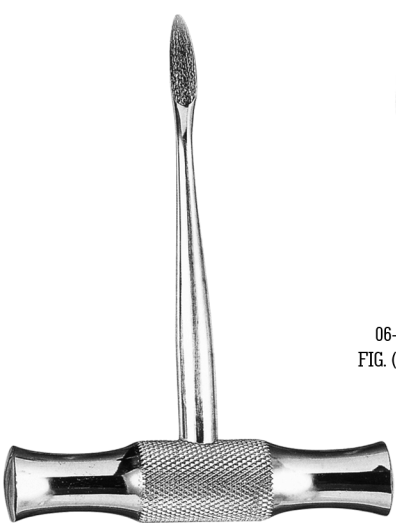

06-0288-00
FIG. (LECLUSE)

06-0289-00
FIG. 321

06-0290-00
FIG. 320

06-0291-00
FIG. 323

06-0292-00
FIG. 322

06-0293-00
FIG. 351

06-0294-00
FIG. 350

ROOT TIP PICK

06-0295-1
FIG.1

06-0296-2
FIG.2
(WARWICK-JAMES)

06-0297-3
FIG.3



WINTER

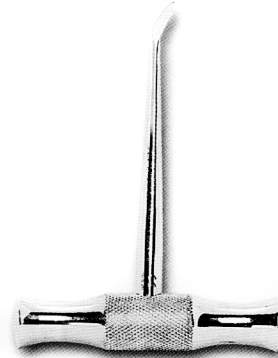

06-0298-1
FIG.
(HEIDBRINK)

06-0299-2
FIG.2
(HEIDBRINK)

06-0300-3
FIG.3
(HEIDBRINK)



06-0305-3
FIG.3
(WINTER)

06-0306-3
FIG.3
(WINTER)

06-0307-3
FIG.3
(WINTER)

06-0308-3
FIG.3
(WINTER)

SYNDESMOTOMES

06-0301-1
FIG.1
(CHOMPRET)

06-0302-2
FIG.2
(CHOMPRET)

06-0303-3
FIG.3
(CHOMPRET)

06-0304-4
FIG.4
(CHOMPRET)



06-0309-3
FIG.3
(WINTER)

06-0310-3
FIG.3
(WINTER)

06-0311-3
FIG.3
(WINTER)

06-0312-3
FIG.3
(WINTER)

SYNDESMOTOMES / DENTAL CARTRIDGE SYRINGES

SYNDESMOTOMES

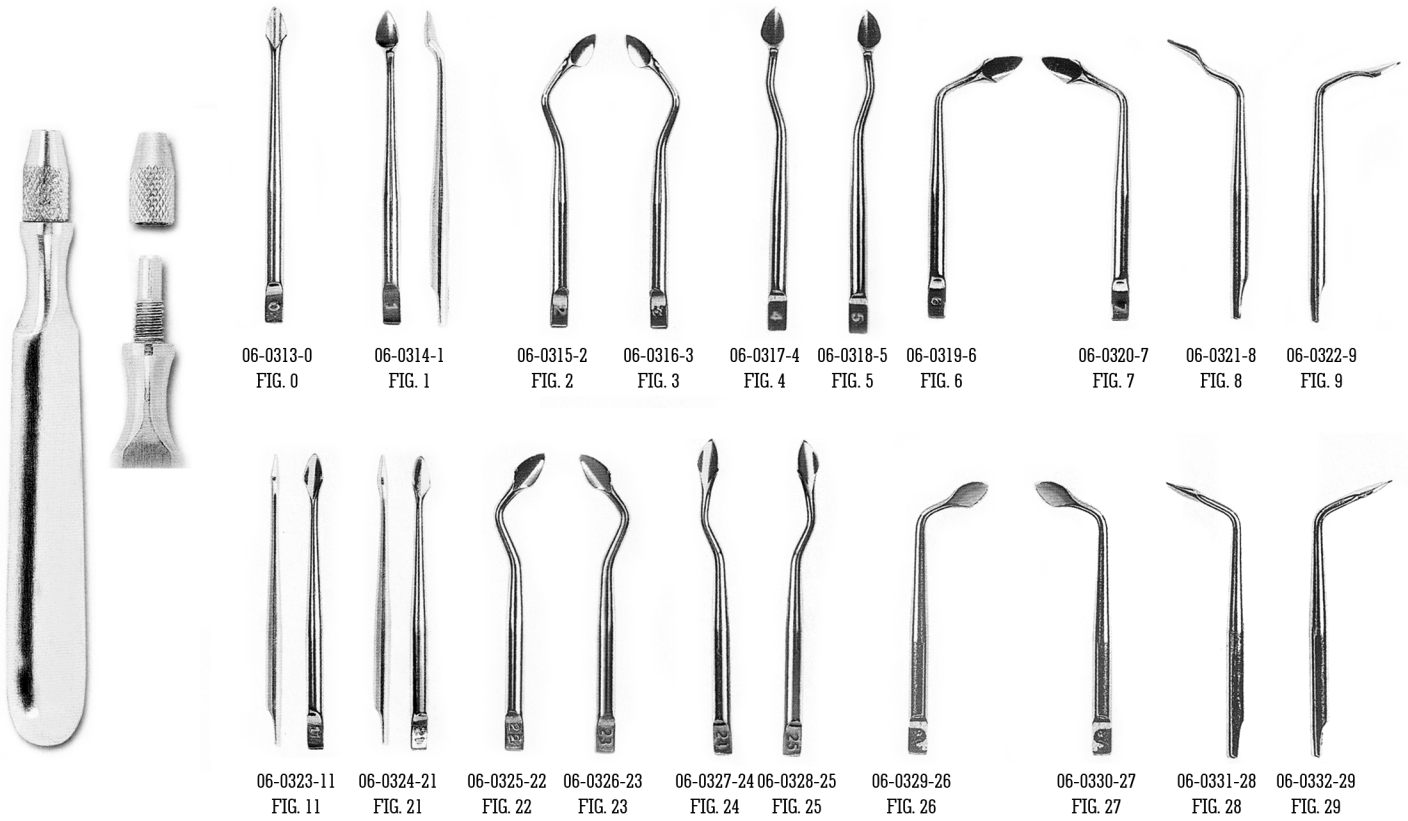

DENTAL CARTRIDGE SYRINGES

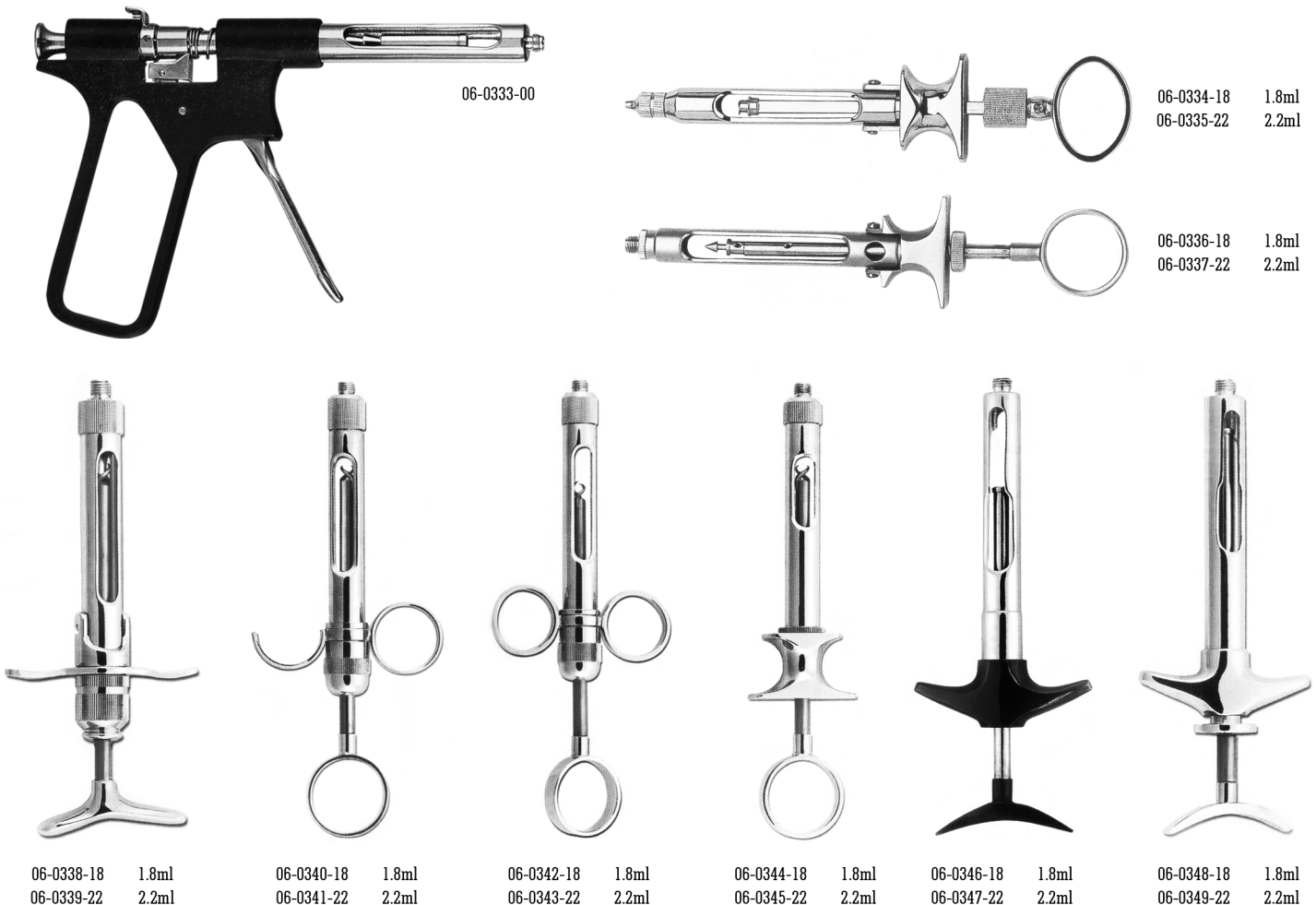

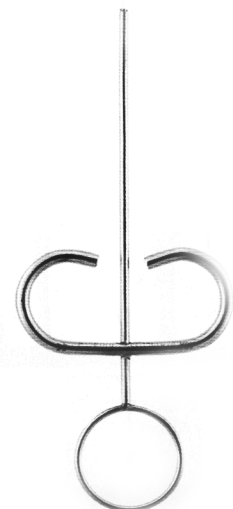
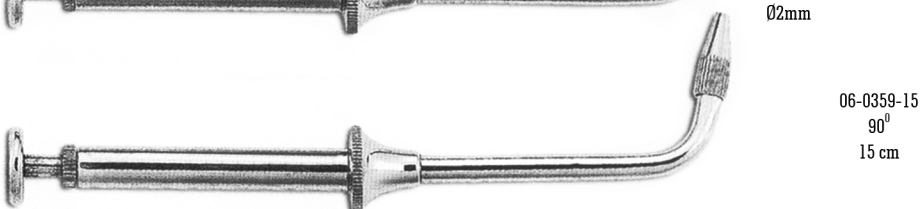
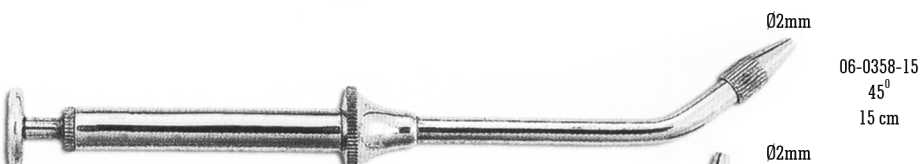
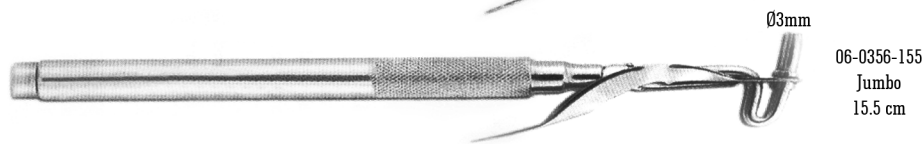
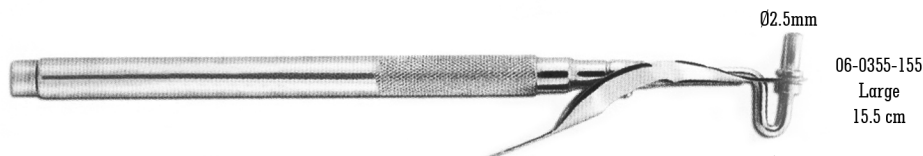
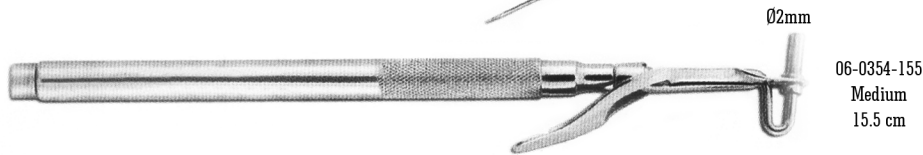
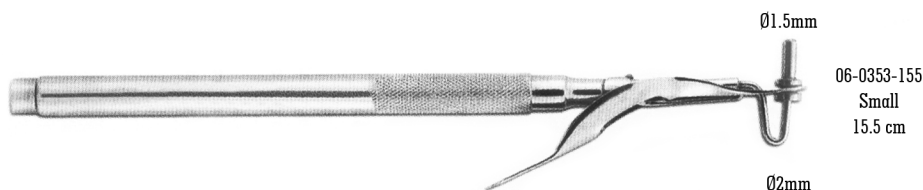
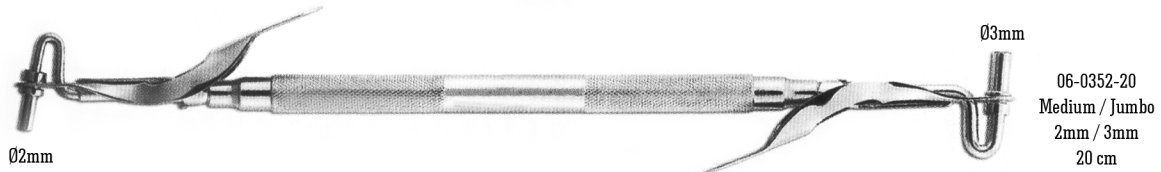
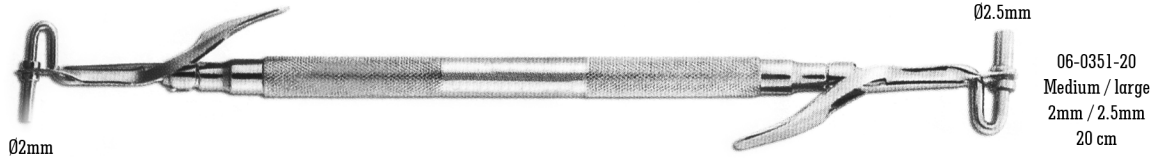
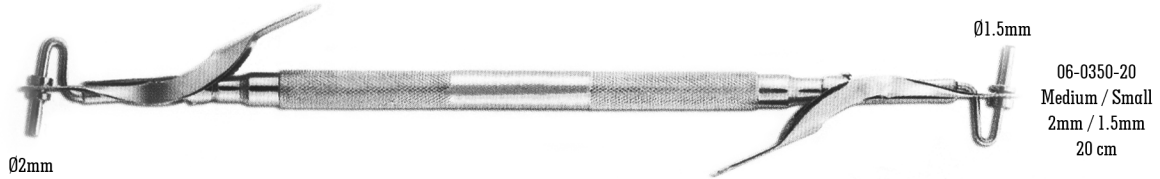

EXTRACTING FORCEPS

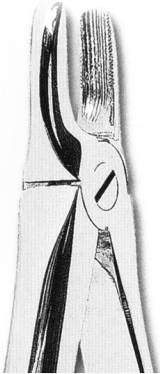

06-0362-1
FIG.1

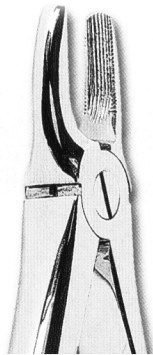

06-0363-2
FIG.2

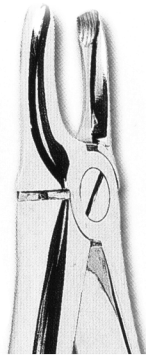

06-0364-3
FIG.3

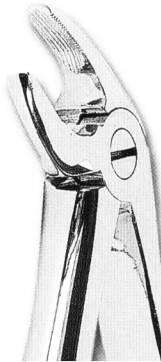

06-0365-4
FIG.4

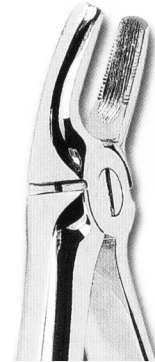

06-0366-7
FIG.7

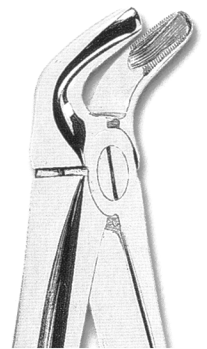

06-0367-8
FIG.8

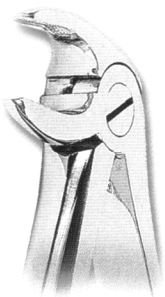

06-0368-13
FIG.13

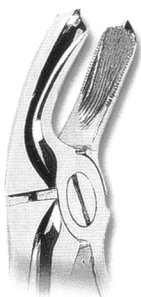

06-0369-18A
FIG.18A



06-0370-17
FIG.17

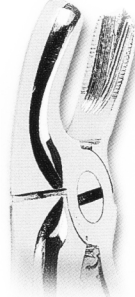

06-0371-18
FIG.18



06-0372-20
FIG.20



06-0373-21
FIG.21

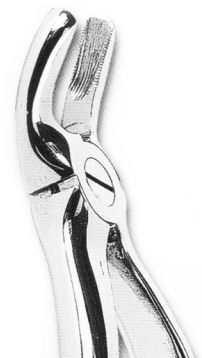

06-0374-19
FIG.19

EXTRACTING FORCEPS



06-0375-22
FIG.22



06-0376-22R
FIG.22R

06-0377-22L
FIG.22L

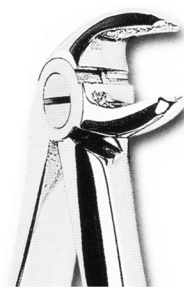

06-0378-23
FIG.23



06-0379-24
FIG.24

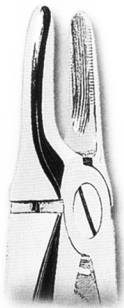

06-0380-29
FIG.29



06-0381-29N
FIG.29N

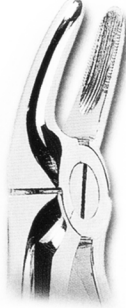

06-0382-30
FIG.30



06-0383-31
FIG.31



06-0384-33
FIG.33



06-0385-33A
FIG.33A



06-0386-33L
FIG.33L



06-0387-38A
FIG.38A

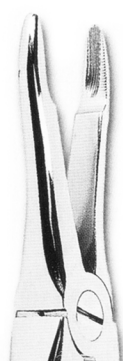

06-0388-41
FIG.41

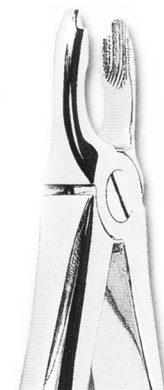

06-0389-43A
FIG.43A



06-0390-44
FIG.44

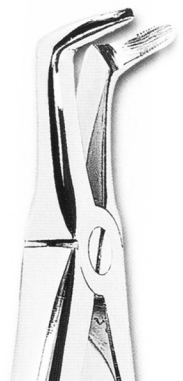

06-0391-45
FIG.45

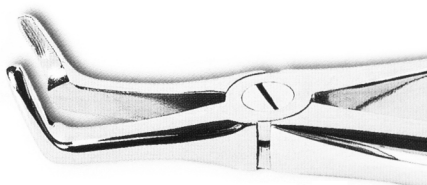

06-0392-46
FIG.46

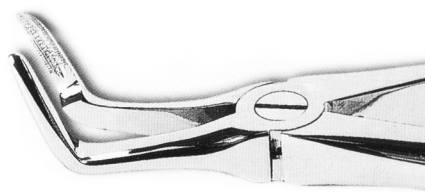

06-0393-46L
FIG.46L

EXTRACTING FORCEPS



06-0394-48
FIG. 48



06-0395-49
FIG. 49

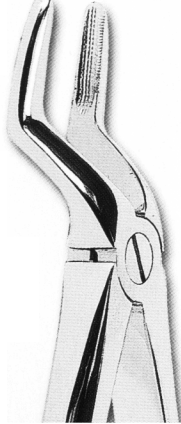

06-0396-51
FIG. 51

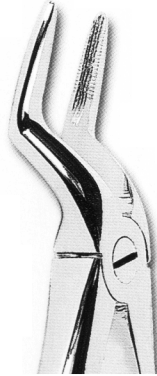

06-0397-51A
FIG. 51A



06-0398-51L
FIG. 51L



06-0399-51LX
FIG. 51LX

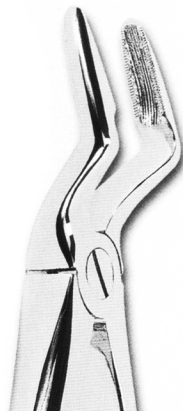

06-0400-52
FIG. 52



06-0401-54
FIG. 54

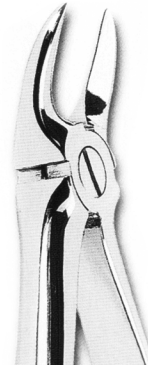

06-0402-55
FIG. 55



06-0403-56
FIG. 56

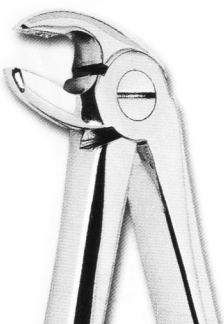

06-0404-59
FIG. 59



06-0405-59L
FIG. 59L



06-0406-60
FIG. 60



06-0407-65L
FIG. 65L



06-0408-65R
FIG. 65R



06-0409-66L
FIG.66L



06-0410-66R
FIG.66R



06-0411-67
FIG.67



06-0412-67A
FIG.67A



06-0413-68
FIG.68



06-0414-67½L
FIG.67½L



06-0415-67½R
FIG.67½R



06-0416-73
FIG.73

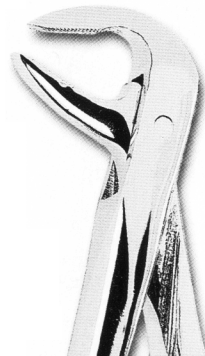

06-0417-74
FIG.74



06-0418-74M
FIG.74M



06-0419-74N
FIG.74N



06-0420-75
FIG.75

EXTRACTING FORCEPS



06-0421-79
FIG.79

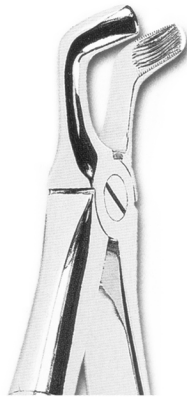

06-0422-79A
FIG.79A

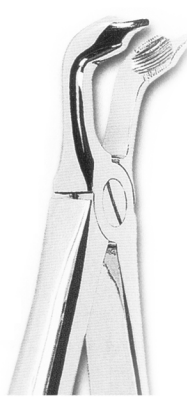

06-0423-79C
FIG.79C



06-0424-86½L
FIG.86½L



06-0425-86½R
FIG.86½R



06-0426-86C
FIG.86C



06-0427-87
FIG.87

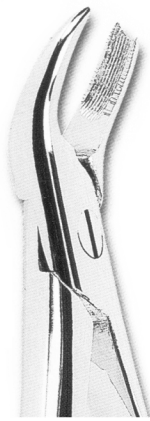

06-0428-89
FIG.89

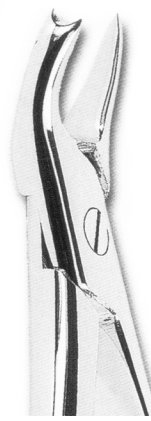

06-0429-90
FIG.90



06-0430-99
FIG.99

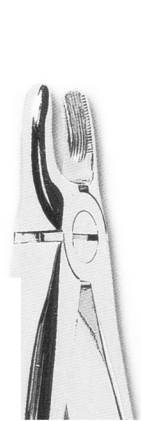

06-0431-107
FIG.107

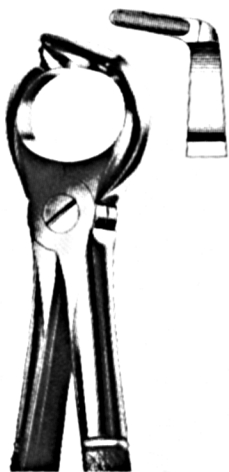

06-0432-99
FIG.99



06-0433-99
FIG.99

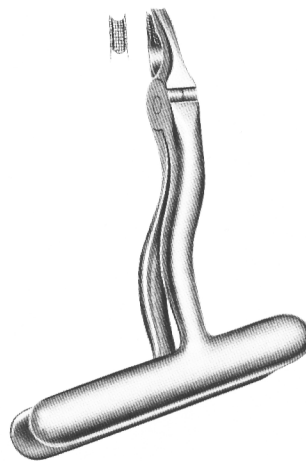

06-0434-99
FIG.99

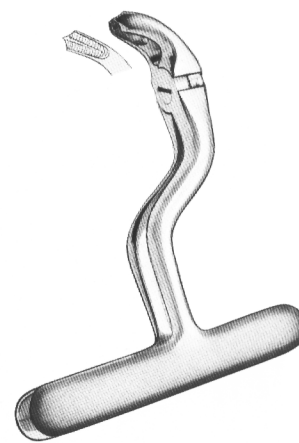

06-0435-99
FIG.99

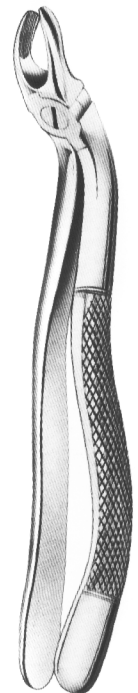

06-0436-99
FIG.99



06-0437-86W
FIG.86W

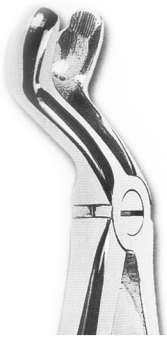

06-0438-121
FIG.121

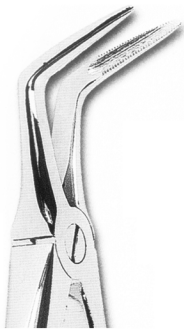

06-0439-145
FIG.145



06-0440-151½
FIG.151½

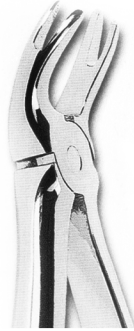

06-041-166
FIG.166



06-0442-167
FIG.167

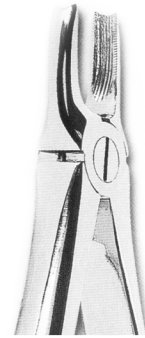

06-0443-168
FIG.168



06-0444-169
FIG.169

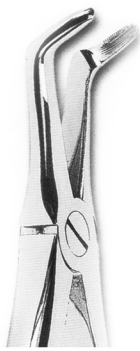

06-0445-346
FIG.346

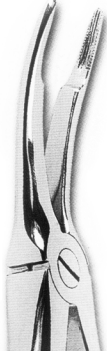

06-0446-349
FIG.349



06-0447-359
FIG.359

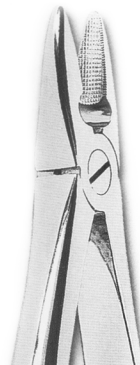

06-0448-1
FIG.1



06-0449-2
FIG.2



06-0450-3
FIG.3

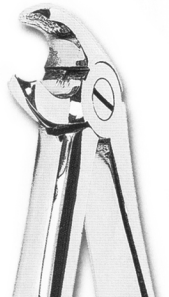

06-0451-4
FIG.4

MEAD PATTERN

ANATOMICALLY SHAPED HANDLES

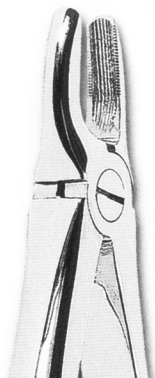

06-0452-1
FIG.1



06-0453-2
FIG.2

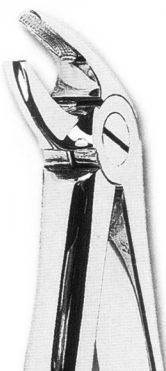

06-0454-4
FIG.4

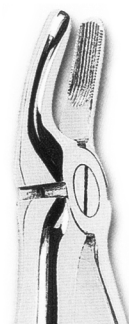

06-0455-7
FIG.7



06-0456-13
FIG.13

EXTRACTING FORCEPS



06-0457-17
FIG.17



06-0458-18
FIG.18

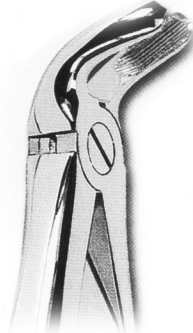

06-0459-21
FIG.21



06-0460-22
FIG.22



06-0461-33
FIG.33

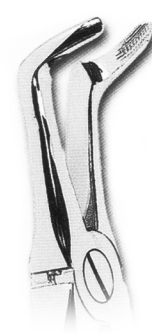

06-0462-45
FIG.45



06-0463-51A
FIG.51A



06-0464-67A
FIG.67A



06-0465-74
FIG.74

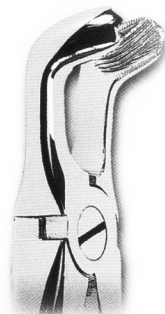

06-0466-79
FIG.79



06-0467-86C
FIG.86C



06-0468-359
FIG.359



06-0469-89
FIG.89

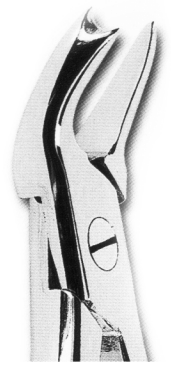

06-0470-90
FIG.90



06-0471-145
FIG.145



06-0472-151½
FIG.151½



06-0473-349
FIG.349

AMERICAN PATTERN

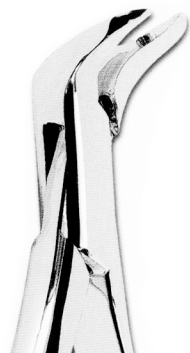

06-0474-5
FIG.5

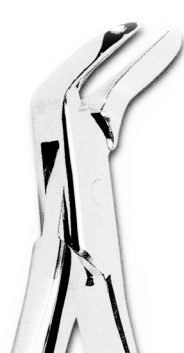

06-0475-6
FIG.6



06-0476-105
FIG.105



06-0477-16
FIG.16



06-0478-17
FIG.17



06-0479-18L
FIG.18L

06-0480-18R
FIG.18R



06-0481-53R
FIG.53R



06-0482-53L
FIG.53L



06-0483-65
FIG.65



06-0484-69
FIG.69 (TOMES)



06-0485-88R
FIG.88R (NEVIUS)



06-0486-88L
FIG.88L (NEVIUS)

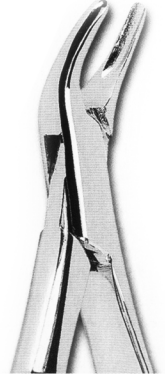

06-0487-101
FIG.101 (HULL)



06-0488-150
FIG.150 (CRYER)



06-0489-150S
FIG.150S (CRYER)



06-0490-151
FIG.151 (CRYER)



06-0491-151S
FIG.151S (CRYER)

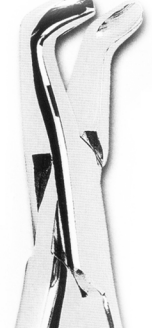

06-0492-222
FIG.222

EXTRACTING FORCEPS

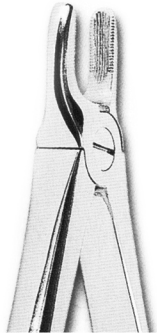

06-0493-37
FIG.37

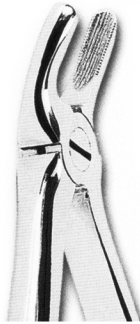

06-0494-39
FIG.39



06-0495-39R
FIG.39R



06-0496-39L
FIG.39L



06-0497-51S
FIG.51S



06-0498-13S
FIG.13S



06-0499-22S
FIG.22S

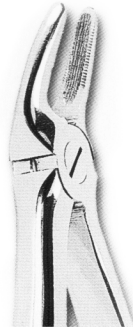

06-0500-30S
FIG.30S



06-0501-33S
FIG.33S



06-0502-38
FIG.38

KLEIN PATTERN



06-0503-1
FIG.1

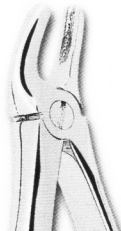

06-0504-2
FIG.2

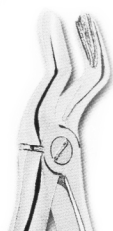

06-0505-3
FIG.3



06-0506-4
FIG.4



06-0507-5
FIG.5



06-0508-6
FIG.6



06-0509-7
FIG.7

ROOT SPLINTER FORCEPS



06-0510-1
FIG.1 (WITZEL)



06-0511-2
FIG.2 (WITZEL)

NEEDLE HOLDERS



06-0512-16
GILLIES
16cm



06-0513-16
GILLIES TC
16cm



06-0514-15
FINE SWEDISH TC
15cm

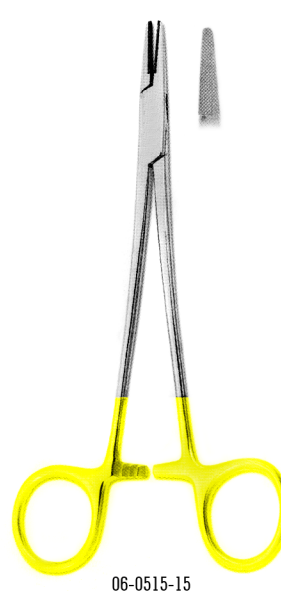

06-0515-15
MICRO-VASCULAR TC
15cm

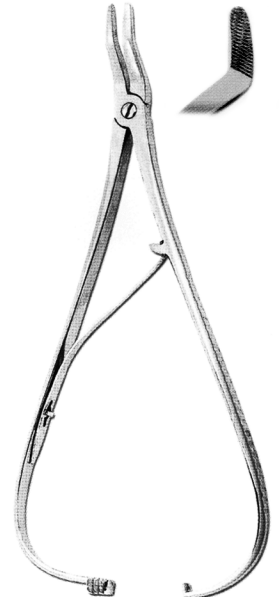

06-0516-195
EISELBERG-MATHIEU
19.5cm

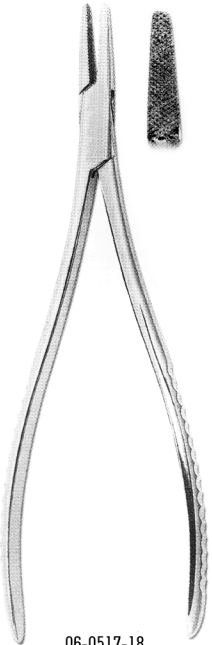

06-0517-18
TOENNIS
18cm

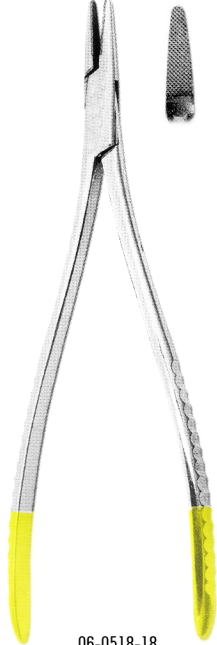

06-0518-18
TOENNIS TC
18cm



06-0519-17
LICHTENBERG
17cm



06-0520-17
LICHTENBERG TC
17cm

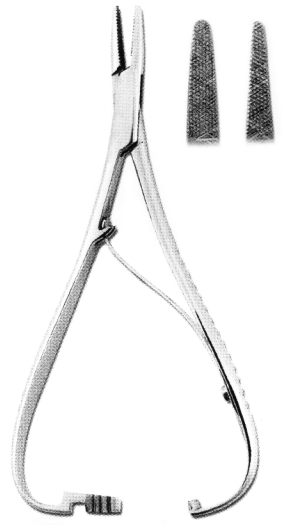

MATHIEU
06-0521-14 14cm
06-0522-17 17cm



MATHIEU TC
06-0523-14 14cm
06-0524-17 17cm

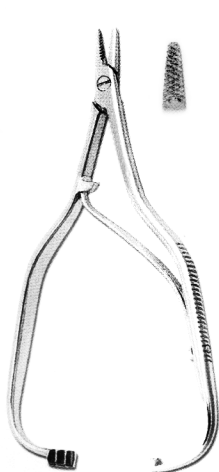

BOYNTON
06-0525-12 12cm
ARRUGA
06-0526-16 16cm

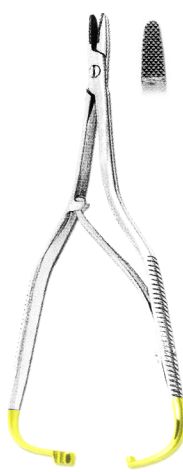

BOYNTON TC
06-0527-12 12cm
ARRUGA TC
06-0528-16 16cm

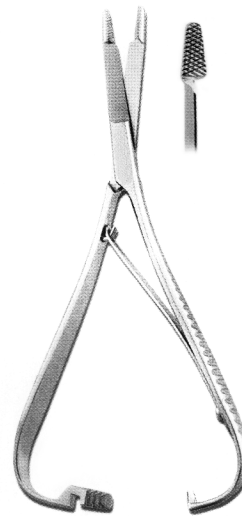

06-0529-14
MATHIEU
14cm

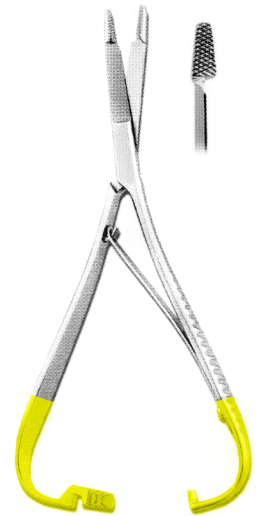

06-0530-14
MATHIEU TC
14cm

NEEDLE HOLDERS



06-0531-14
OLSEN-HEGAR
14cm



06-0532-14
OLSEN-HEGAR TC
14cm



06-0533-145
BAUMGARTNER
14.5cm



06-0534-175
ADSON
17.5cm



06-0535-15
CRILE-WOOD
15cm



06-0536-15
CRILE-WOOD TC
15cm

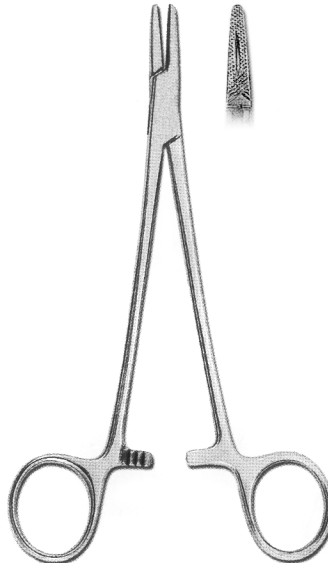

MAYO-HEGAR
06-0537-16 16cm
06-0538-18 18cm



MAYO-HEGAR TC
06-0539-16 16cm
06-0540-18 18cm

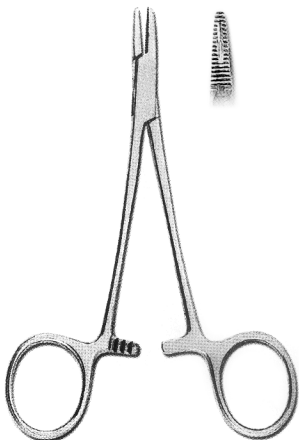

06-0541-12
DERF
12cm



06-0542-12
DERF TC
12cm



06-0543-14
HEGAR-BAUMGARTNER TC
14cm



MINI-RYDER TC
06-0544-15 15cm
06-0545-18 18cm



06-0546-13
HALSEY-SMOOTH
13cm (Smooth Jaws)

06-0547-13
HALSEY
13cm (Smooth Jaws)

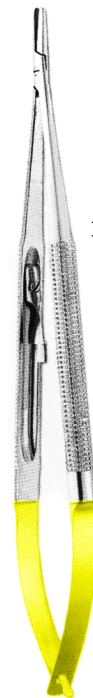

06-0549-18
MICRO-BARRAQUER TC
18cm

06-0548-18
MICRO-BARRAQUER TC
18cm

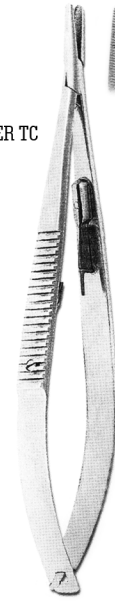

CASTROVIEJO
06-0550-14 14cm
06-0551-18 18cm

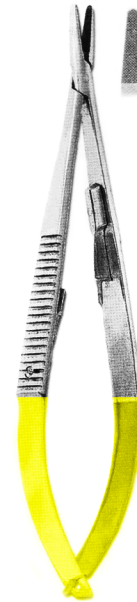

CASTROVIEJO TC
06-0552-14 14cm
06-0553-18 18cm

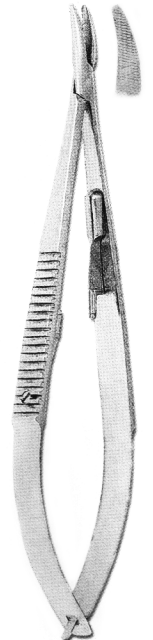

CASTROVIEJO
06-0554-14 14cm
06-0555-18 18cm

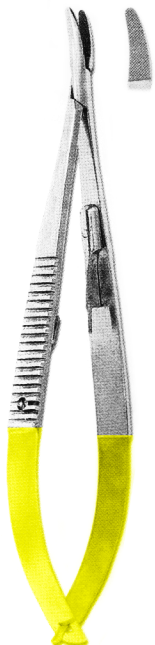

CASTROVIEJO TC
06-0556-14 14cm
06-0557-18 18cm

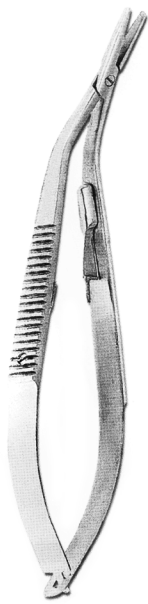

06-0558-14
CASTROVIEJO 60°
14cm

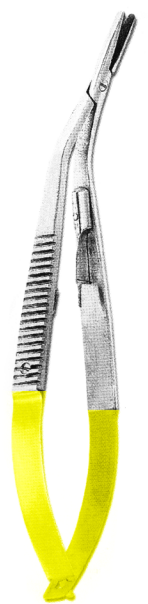

06-0559-14
CASTROVIEJO TC 60°
14cm

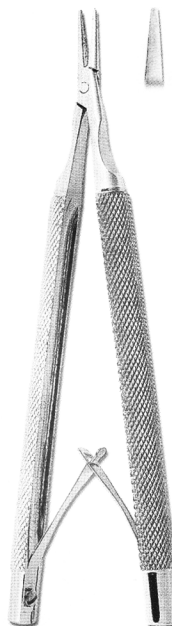

06-0560-13
CASTROVIEJO
13cm (Smooth Jaws)

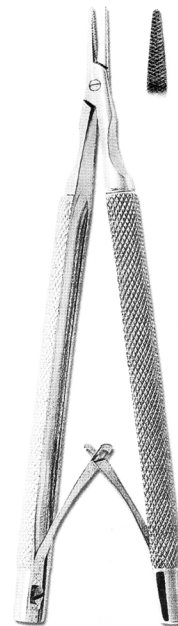

06-0561-13
CASTROVIEJO
13cm (Serrated Jaws)

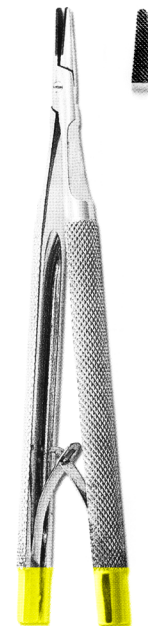

06-0562-13
CASTROVIEJO TC
13cm

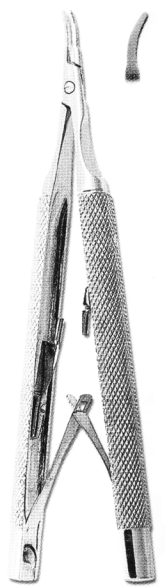

06-0563-13
CASTROVIEJO-BARRAQUER
(SMOOTH JAWS)
13cm

ROOT, SPLINTER, DRESSING & HAEMOSTATIC FORCEPS



BACKHAUS
06-0564-08 8cm
06-0565-11 11cm
06-0566-13 13cm

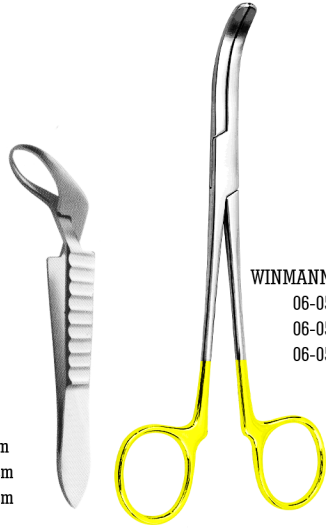

WINMANN CROWN TC
06-0568-14
06-0568-16
06-0568-18



06-0569-135
STIEGLITZ
13.5 cm

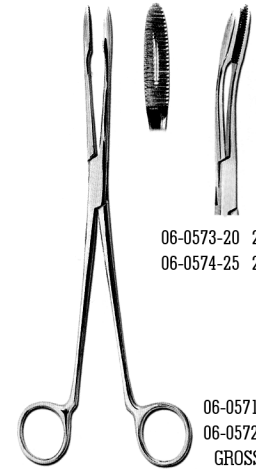

06-0573-20 20cm
06-0574-25 25cm

06-0570-135
STIEGLITZ
13.5 cm

06-0571-20 20cm
06-0572-25 25cm
GROSS-MAIRE

JONES
06-0567-90 90 mm



06-0575-00



06-0576-00

06-0575-14 & 06-0576-14
CRILE
14cm



06-0577-00



06-0578-00

06-0577-14 & 06-0578-14
KOCHER
14cm



06-0579-00



06-0580-00

06-0579-14 & 06-0580-14
PEAN
14cm



06-0581-00



06-0582-00

06-0581-12 & 06-0582-12
HALSTEAD-MOSQUITO
12cm



06-0583-00



06-0584-00

06-0583-12 & 06-0584-12
HALSTEAD-MOSQUITO
12cm



06-0585-00



06-0586-00

06-0585-14 & 06-0586-14
KELLY
14cm



06-0587-00



06-0588-00

06-0587-10 & 06-0588-10
MICRO-MOSQUITO
10cm

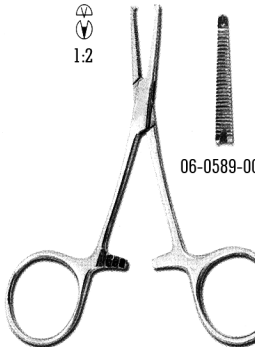

06-0589-00



06-0590-00

06-0589-10 & 06-0590-10
MICRO-MOSQUITO
10cm



06-0591-00



06-0592-00

06-0591-10 & 06-0592-10
HARTMAN
10cm

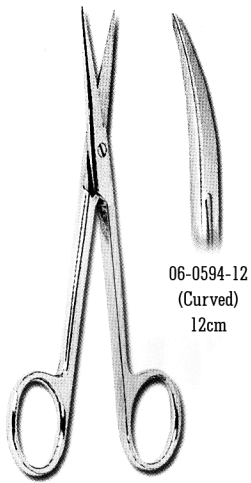

06-0594-12
(Curved)
12cm

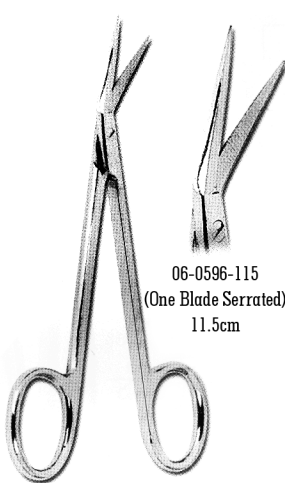

06-0596-115
(One Blade Serrated)
11.5cm



06-0598-115
IRIS (Curved)
11.5cm

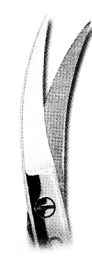

06-0599-115
IRIS
11.5cm



06-0601-115
IRIS (Curved) TC
11.5cm

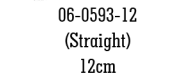

06-0593-12
(Straight)
12cm

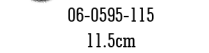

06-0595-115
11.5cm

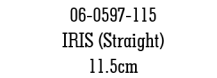

06-0597-115
IRIS (Straight)
11.5cm

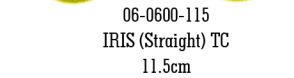

06-0600-115
IRIS (Straight) TC
11.5cm



06-0603-13
GOLDMAN-FOX (Curved)
13cm (One Blade Serrated)

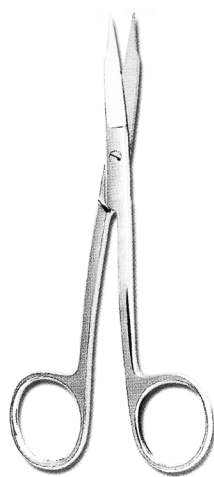

06-0604-13
GOLDMAN-FOX (Special)
13cm (One Blade Serrated)



06-0606-13
GOLDMAN-FOX (Curved) TC
13cm

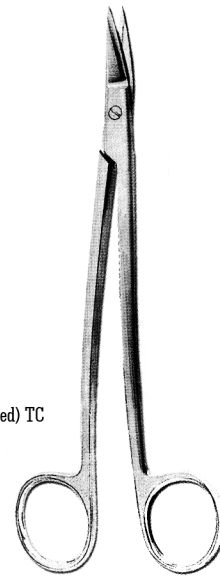

06-0607-17
DEAN
17cm

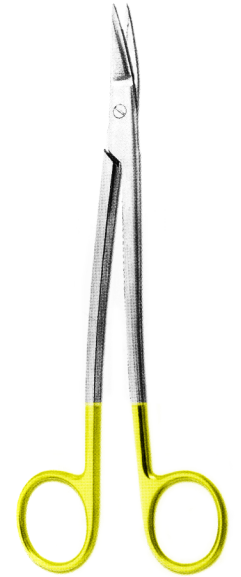

06-0608-17
DEAN TC
17cm

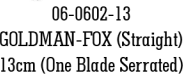

06-0602-13
GOLDMAN-FOX (Straight)
13cm (One Blade Serrated)



06-0605-13
GOLDMAN-FOX (Straight) TC
13cm



06-0609-125
NEUMANN (Curved)
12.5cm



06-0610-105
LA GRANGE (Curved, One Blade Serrated)
10.5cm



06-0612-125
QUINBY (Curved)
12.5cm



06-0614-16
KELLY (Curved)
16cm

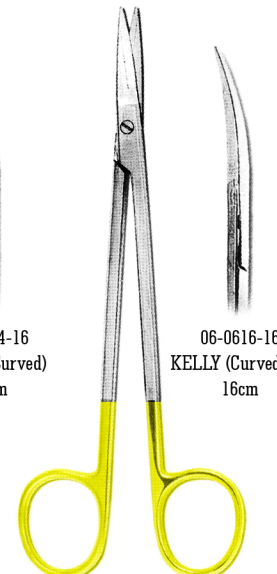

06-0616-16
KELLY (Curved) TC
16cm

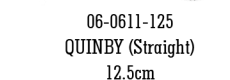

06-0611-125
QUINBY (Straight)
12.5cm



06-0613-16
KELLY (Straight)
16cm

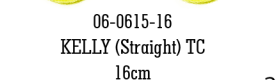

06-0615-16
KELLY (Straight) TC
16cm

SCISSORS



DRESSING AND TISSUE FORCEPS

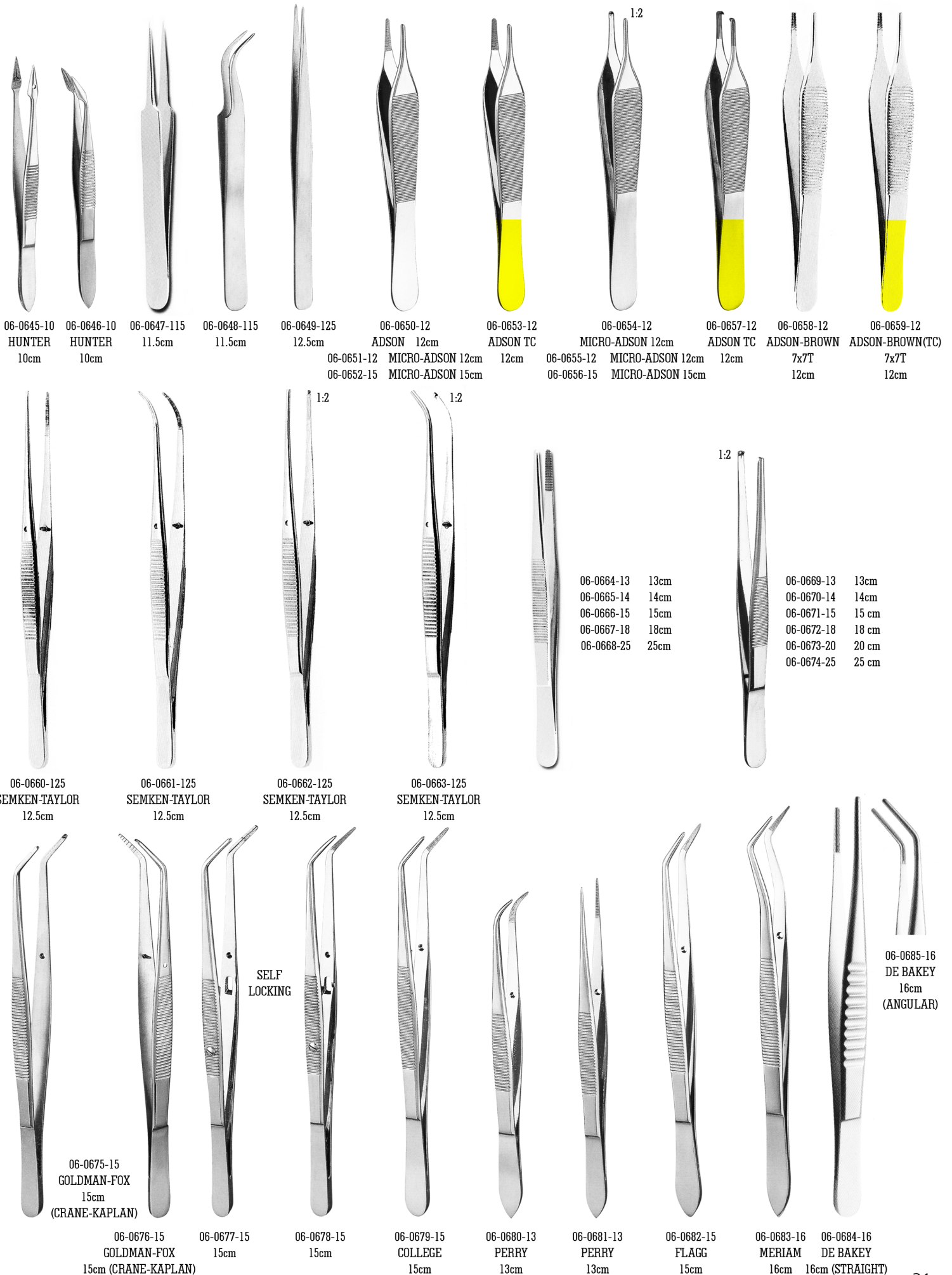

SCALERS

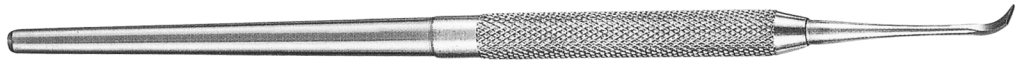

06-0686-1R
FIG. 1R
(RIGHT)

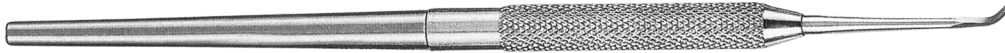

06-0687-1L
FIG. 1L
(LEFT)

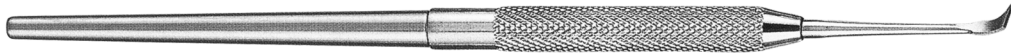

06-0688-2R
FIG. 2R
(RIGHT)

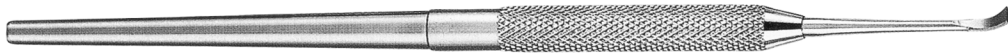

06-0689-2L
FIG. 2L
(LEFT)

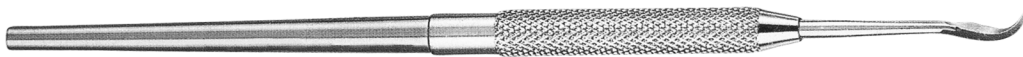

06-0690-1
FIG. 1



06-0691-00

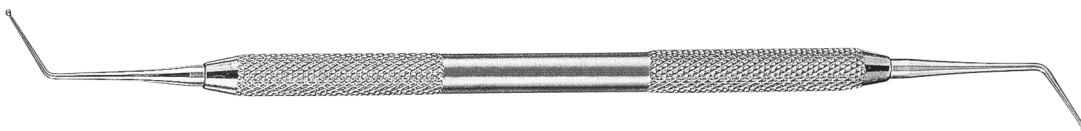

06-0692-00

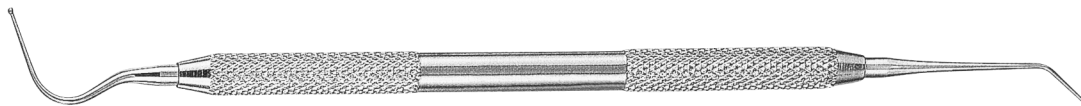

06-0693-00

BONE CURETTES

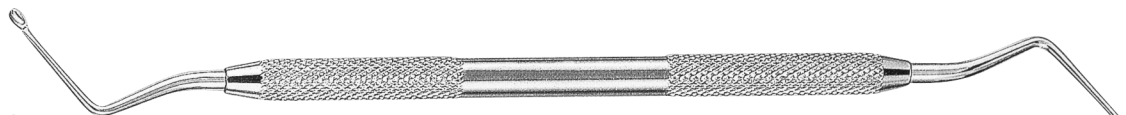

06-0694-1
HEMINGWAY
FIG. 1

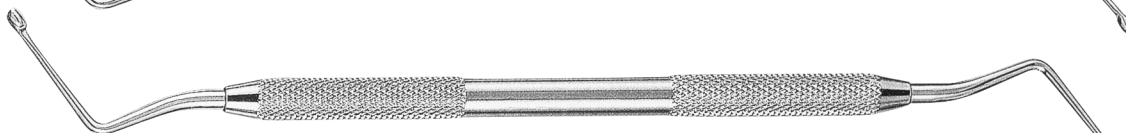

06-0695-2
HEMINGWAY
FIG. 2

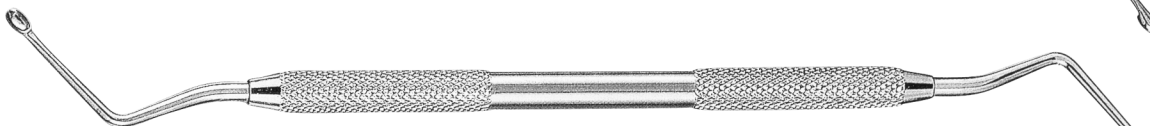

06-0696-3
HEMINGWAY
FIG. 3

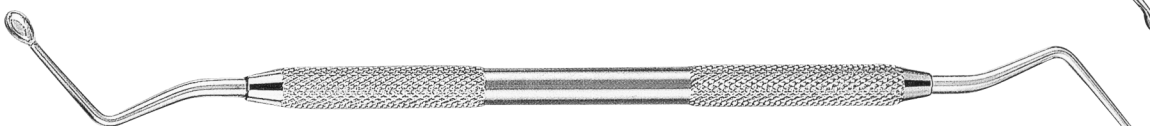

06-0697-4
HEMINGWAY
FIG. 4

ALL ABOVE PRODUCTS ARE ALSO AVAILABLE WITH HOLLOW HANDLES

CURETTES AND SCALERS

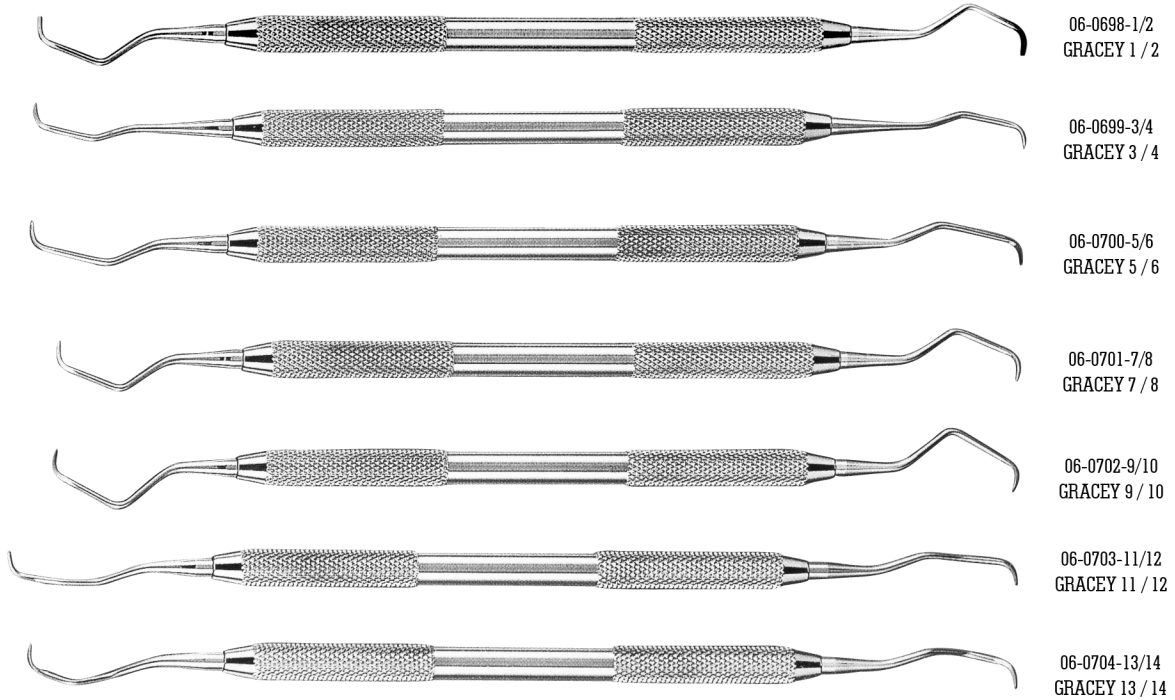

06-0698-1/2
GRACEY 1 / 2

06-0699-3/4
GRACEY 3 / 4

06-0700-5/6
GRACEY 5 / 6

06-0701-7/8
GRACEY 7 / 8

06-0702-9/10
GRACEY 9 / 10

06-0703-11/12
GRACEY 11 / 12

06-0704-13/14
GRACEY 13 / 14

GINGIVECTOMY KNIVES

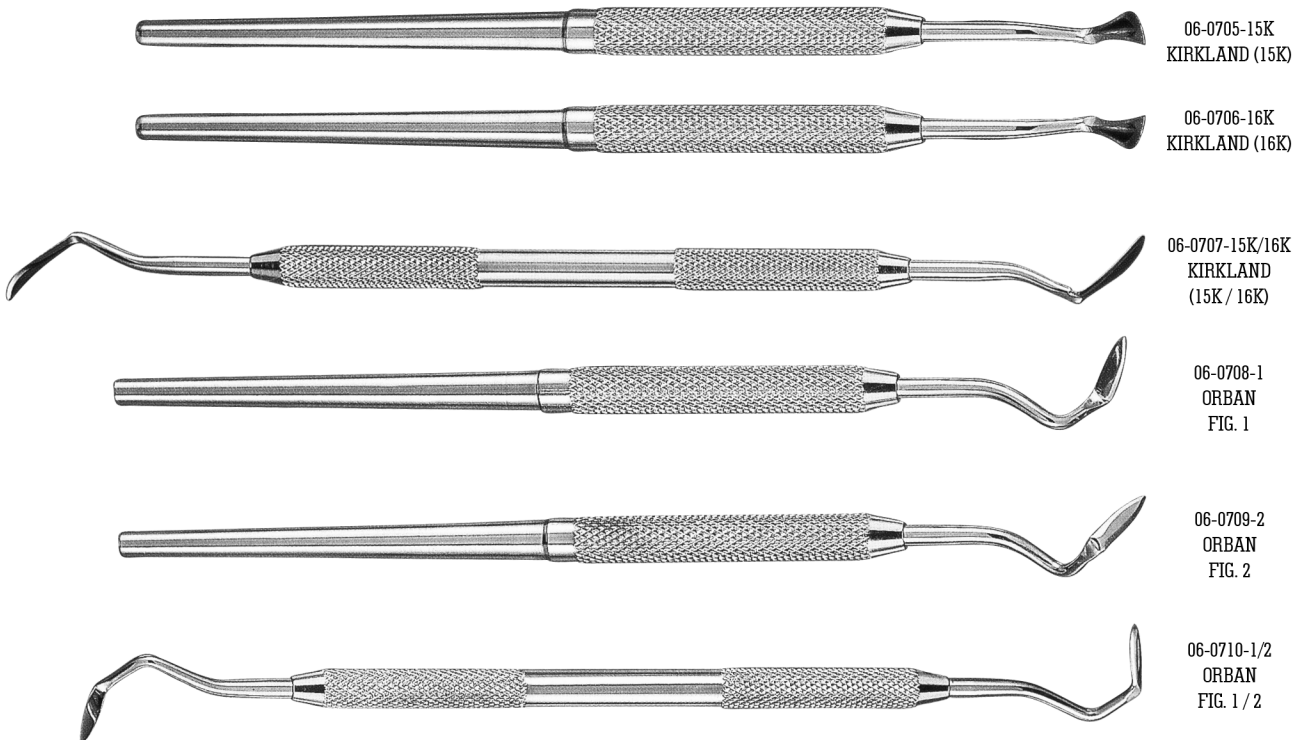

06-0705-15K
KIRKLAND (15K)

06-0706-16K
KIRKLAND (16K)

06-0707-15K/16K
KIRKLAND
(15K / 16K)

06-0708-1
ORBAN
FIG. 1

06-0709-2
ORBAN
FIG. 2

06-0710-1/2
ORBAN
FIG. 1 / 2

CHISELS

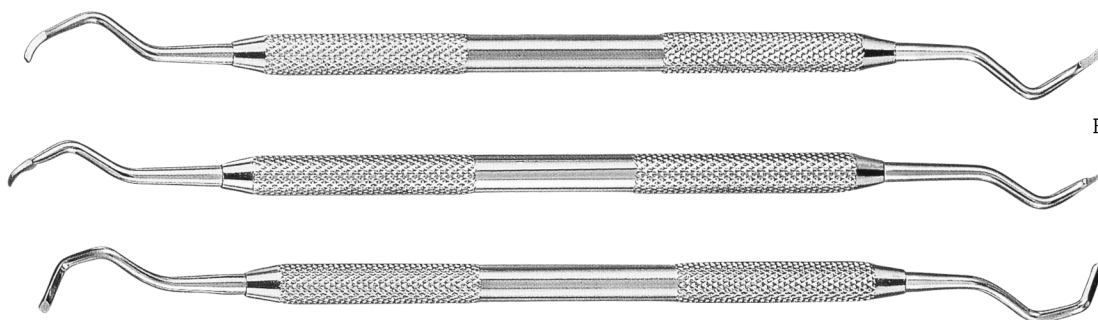

06-0711-36/37
RHODENS
FIG. 36 / 37 (BACK ACTION)

06-0712-4
OCHSENBEIN
FIG. 4

06-0713-3
OCHSENBEIN
FIG. 3

GINGIVECTOMY KNIVES



06-0714-1/2
SANDERS
FIG. 1 / 2

06-0715-4/5
SANDERS
FIG. 4 / 5

06-0716-19/20
USC-TOWNER
FIG. 19 / 20

06-0717-CK3
CRANE KAPLAN
FIG. CK3

06-0718-8
GOLDMANN-FOX
FIG. 8

06-0719-7
GOLDMANN-FOX
FIG. 7

06-0720-9
GOLDMANN-FOX
FIG. 9

06-0721-11
GOLDMANN-FOX
FIG. 11

FILES

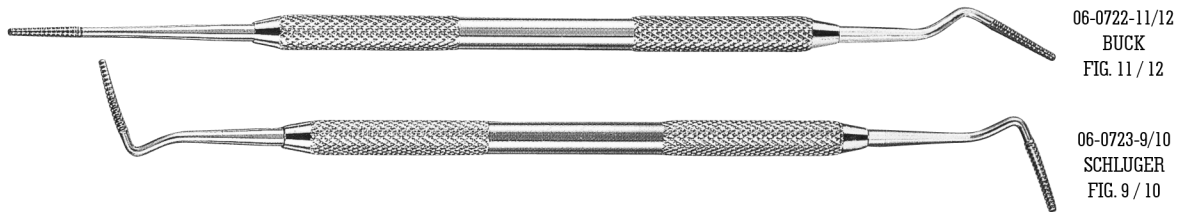

06-0722-11/12
BUCK
FIG. 11 / 12

06-0723-9/10
SCHLUGER
FIG. 9 / 10

CURETTES AND SCALERS



06-0724-7/8
YOUNGER-GOOD
FIG. 7 / 8

06-0725-6
CRANE-KAPLAN
FIG. 6

06-0726-00
TAYLOR

06-0727-00
TAYLOR

06-0728-00
TAYLOR

06-0729-00
TAYLOR

06-0730-5/6
BUCK
FIG. 5 / 6







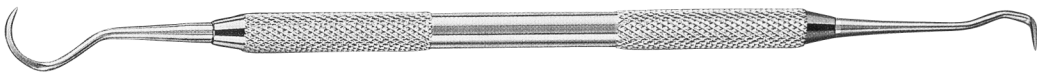
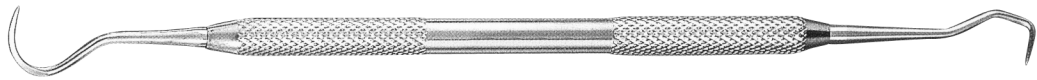
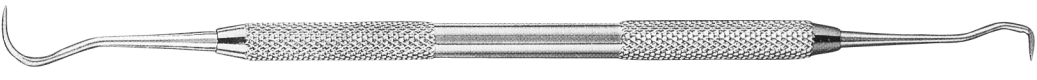
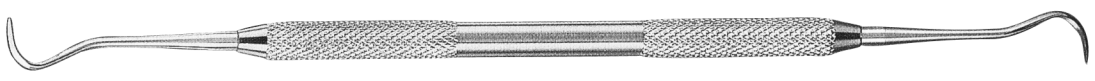
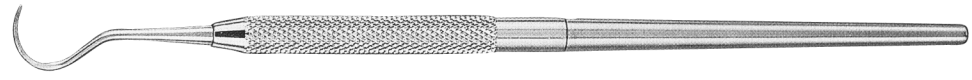
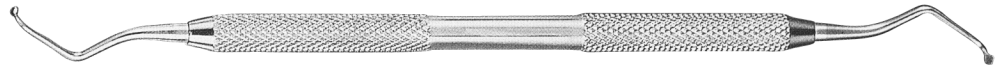
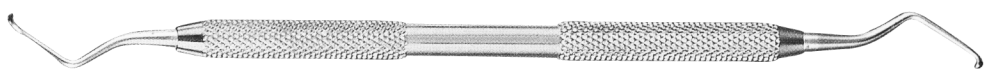
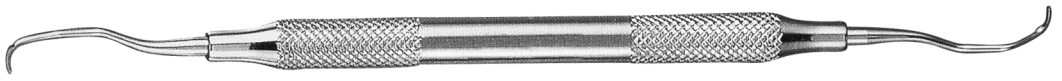
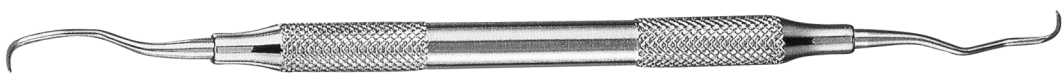
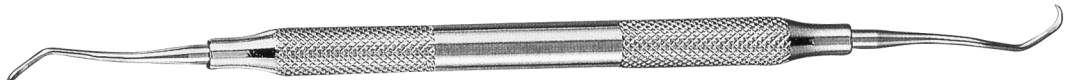
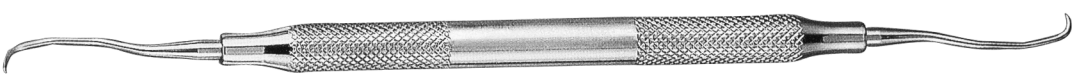
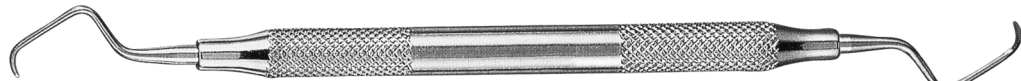
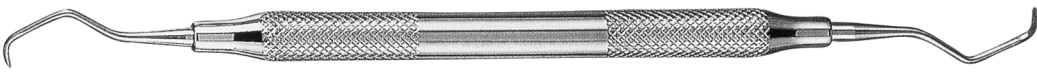
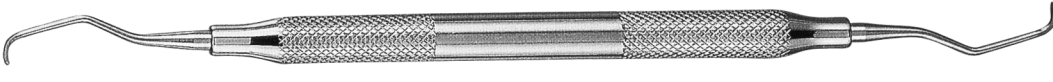
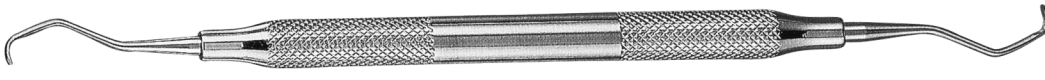
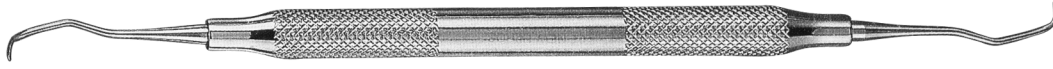

06-0731-3/4
BUCK
FIG. 3 / 4

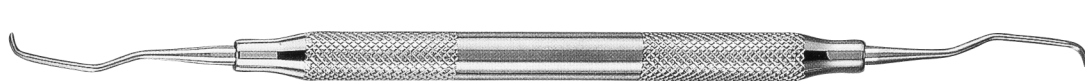
ALL ABOVE PRODUCTS ARE ALSO AVAILABLE WITH HOLLOW HANDLES

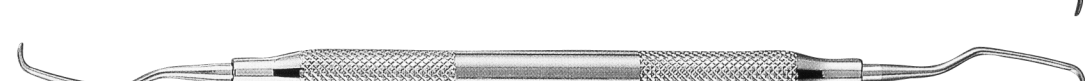
CURETTES AND SCALERS

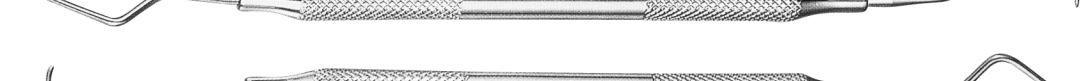
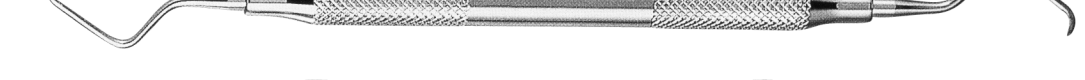
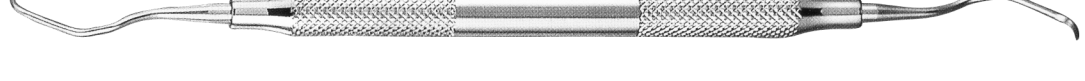
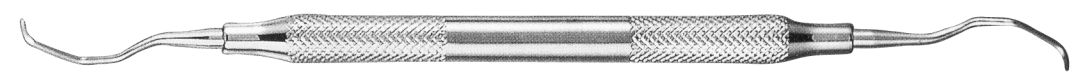
	06-0732-U15/30 TOWNER JAQUETTE FIG. U15 / 30
	06-0733-U15/33 TOWNER JAQUETTE FIG. U15 / 33
	06-0734-H5/33 TOWNER JAQUETTE FIG. H5 / 33
	06-0735-H6/H7 TOWNER JAQUETTE FIG. H6 / H7
	06-0736-U15 TOWNER FIG. U15
	06-0737-2 DE MARCO FIG. 2
	06-0738-1 DE MARCO FIG. 1
	06-0739-11/14 GRACEY MESIAL DISTAL FIG. 11 / 14
	06-0740-12/13 GRACEY MESIAL DISTAL FIG. 12 / 13
	06-0741-13/14 GRACEY FIG. 13 / 14 AF/TYPE
	06-0742-11/12 GRACEY FIG. 11 / 12 AF/TYPE
	06-0743-9/10 GRACEY FIG. 9 / 10 AF/TYPE
	06-0744-7/8 GRACEY FIG. 7 / 8 AF/TYPE
	06-0745-5/6 GRACEY FIG. 5 / 6 AF/TYPE
	06-0746-3/4 GRACEY FIG. 3 / 4 AF/TYPE
	06-0747-1/2 GRACEY FIG. 1 / 2 AF/TYPE

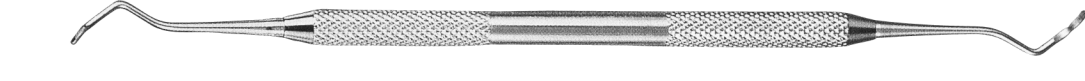
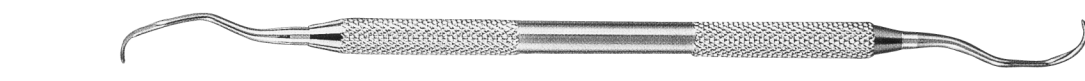
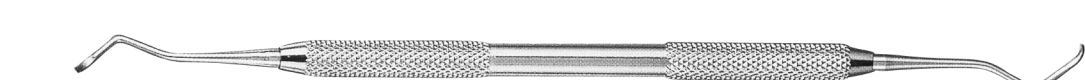
CURETTES AND SCALERS

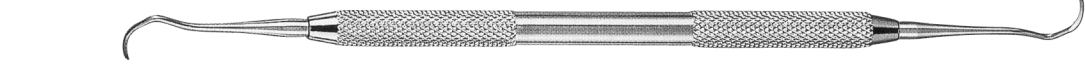
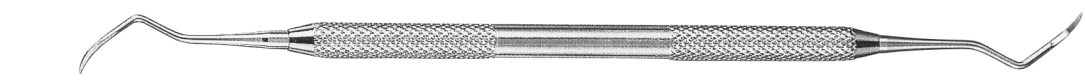
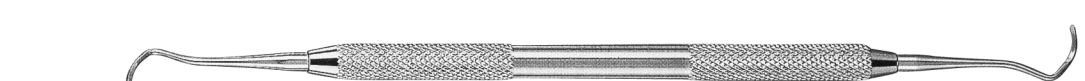
	06-0748-1/2 GRACEY FIG. 1 / 2 MF/TYPE
	06-0749-3/4 GRACEY FIG. 3 / 4 MF/TYPE
	06-0750-5/6 GRACEY FIG. 5 / 6 MF/TYPE
	06-0751-7/8 GRACEY FIG. 7 / 8 MF/TYPE
	06-0752-9/10 GRACEY FIG. 9 / 10 MF/TYPE
	06-0753-11/12 GRACEY FIG. 11 / 12 MF/TYPE
	06-0754-13/14 GRACEY FIG. 13 / 14 MF/TYPE
	06-0755-5/6 BARNHART FIG. 5 / 6
	06-0756-1/2 BARNHART FIG. 1 / 2
	06-0757-4R/4L COLUMBIA FIG. 4R / 4L
	06-0758-13/14 COLUMBIA FIG. 13 / 14
	06-0759-00 COLUMBIA
	06-0760-00 COLUMBIA
	06-0761-00 COLUMBIA
	06-0762-HU1/2 COLUMBIA FIG. HU1 / 2
	06-0763-17/18 INDIANA UNIVERSITY FIG. 17 / 18
	06-0764-13/14 INDIANA UNIVERSITY FIG. 13 / 14

ALL ABOVE PRODUCTS ARE ALSO AVAILABLE WITH HOLLOW HANDLES

CURETTES AND SCALERS

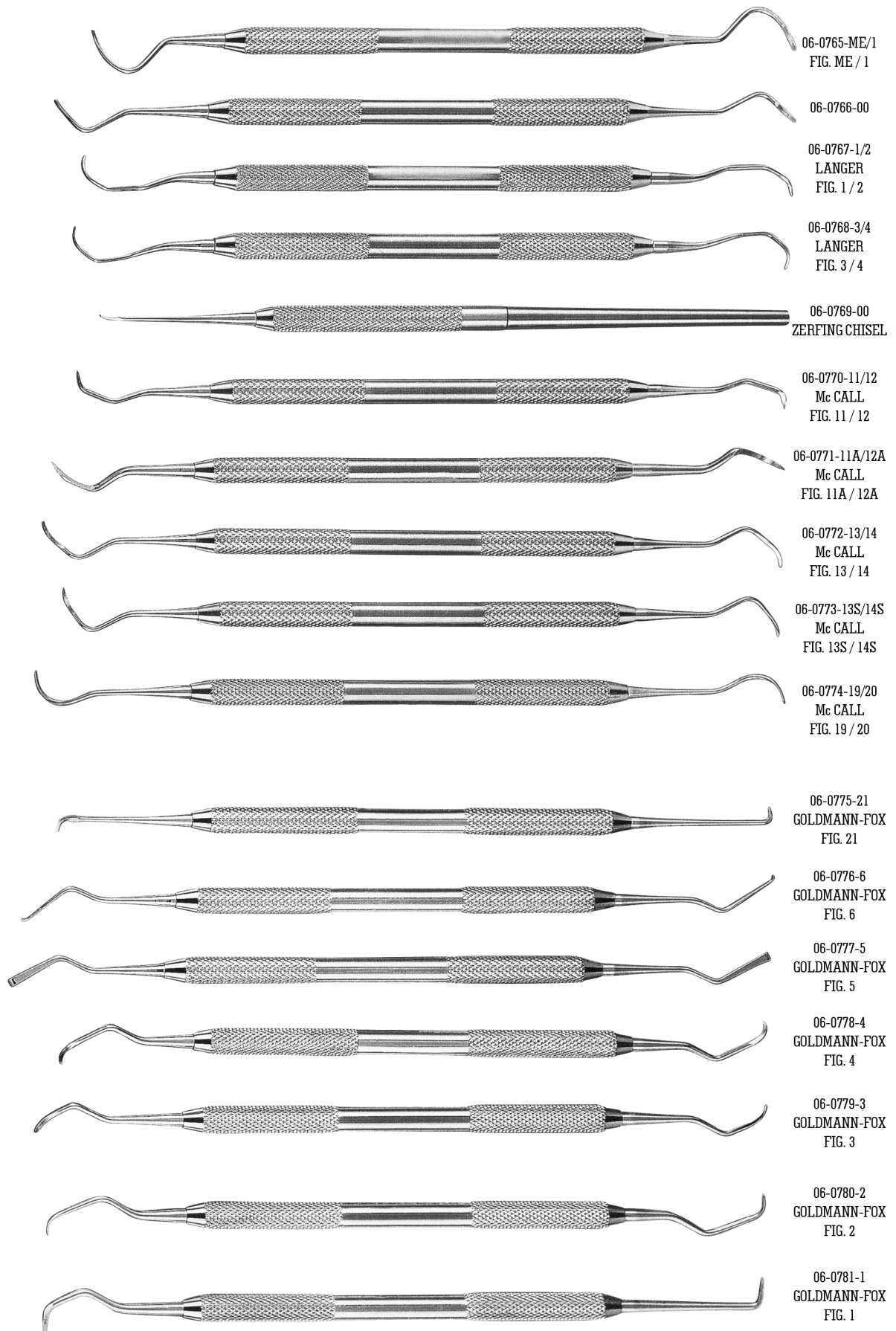

EXPLORERS

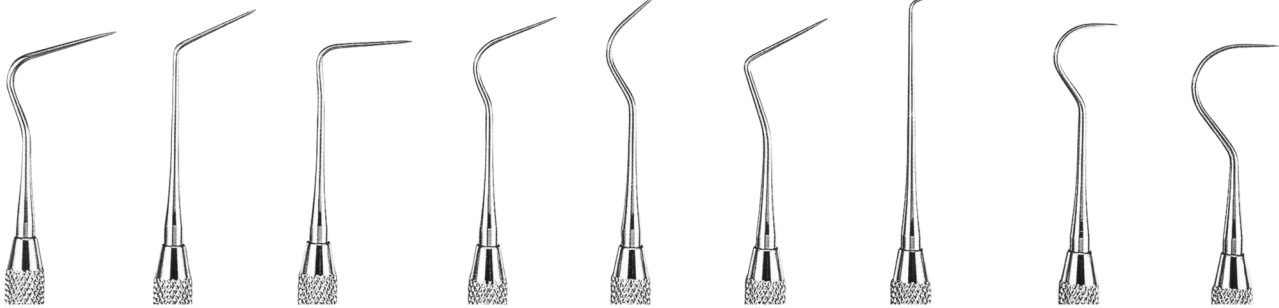
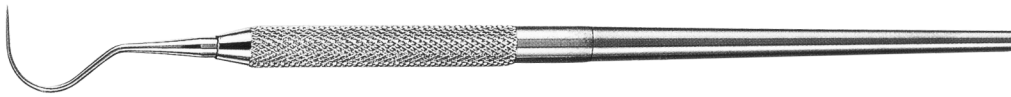

06-0782-8 FIG. 8 06-0783-6 FIG. 6 06-0784-11 FIG. 11 06-0785-12 FIG. 12 06-0786-10 FIG. 10 06-0787-9 FIG. 9 06-0788-16 FIG. 16 06-0789-2 FIG. 2 06-0790-23 FIG. 23



06-0791-17 FIG. 17 06-0792-17A FIG. 17A 06-0793-00 WILLIAMS 06-0794-00 MERIT A 06-0795-00 MERIT B 06-0796-00 GOLDMANN-FOX 06-0797-00 UNIVERSITY OF MICHIGAN 06-0798-26G FIG. 26G

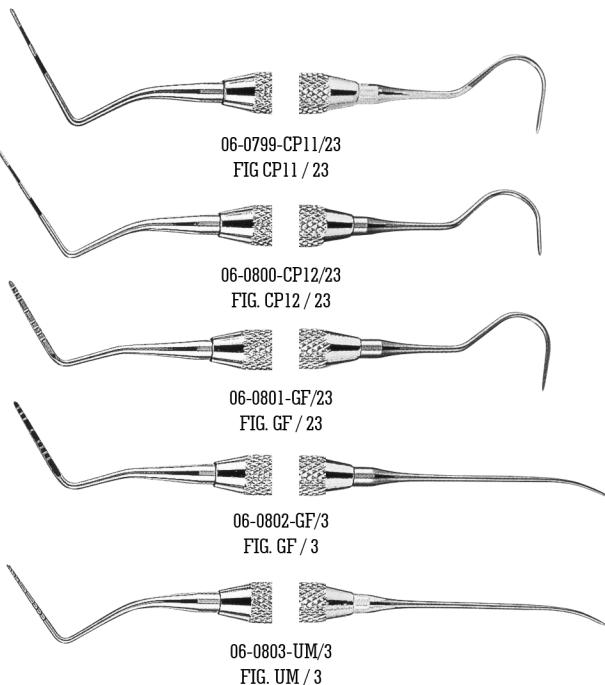
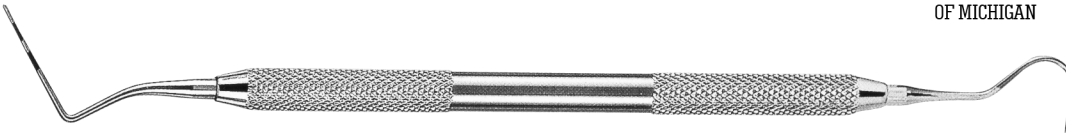

06-0799-CP11/23 FIG. CP11 / 23
06-0800-CP12/23 FIG. CP12 / 23
06-0801-GF/23 FIG. GF / 23
06-0802-GF/3 FIG. GF / 3
06-0803-UM/3 FIG. UM / 3

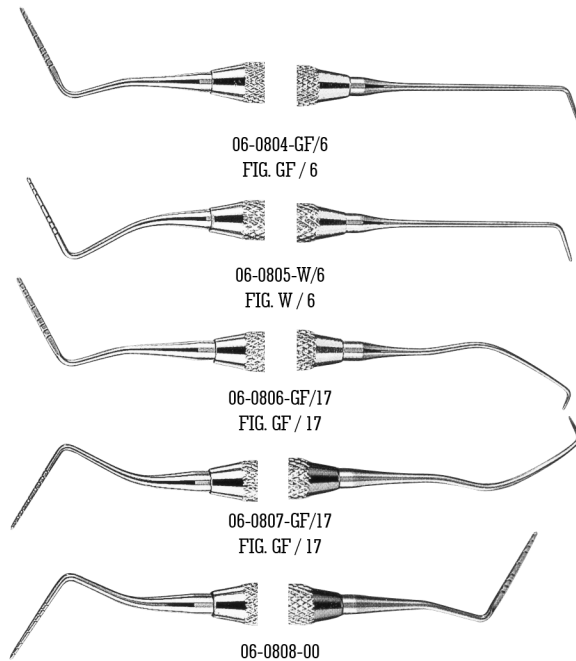

06-0804-GF/6 FIG. GF / 6
06-0805-W/6 FIG. W / 6
06-0806-GF/17 FIG. GF / 17
06-0807-GF/17 FIG. GF / 17
06-0808-00

ALL ABOVE PRODUCTS ARE ALSO AVAILABLE WITH HOLLOW HANDLES



06-0809-00
NABERS 1



06-0812-23/17
FIG. 23 / 17



06-0810-16/17
FIG 16/17

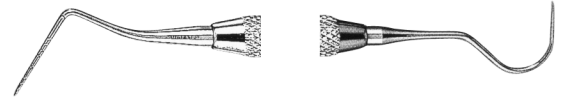

06-0813-W/17
FIG. W / 17



06-0811-23/17A
FIG. 23 / 17A

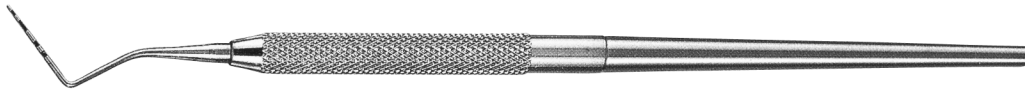

06-0814-WHO
FIG. WHO



06-0815-CP15
FIG. CP15



06-0816-CO12S
FIG. CO12S



06-0817-CP12
FIG. CP12

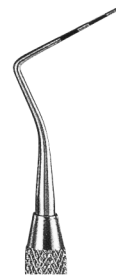

06-0818-CP11
FIG. CP11



06-0819-CO10
FIG. CP10

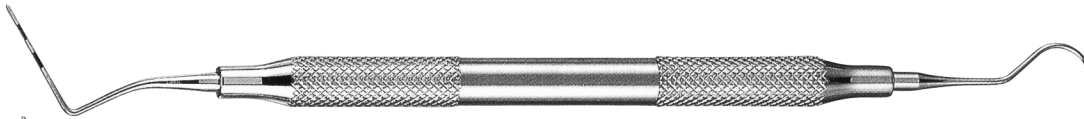

06-0820-CP11/23
FIG. CP11 / 23

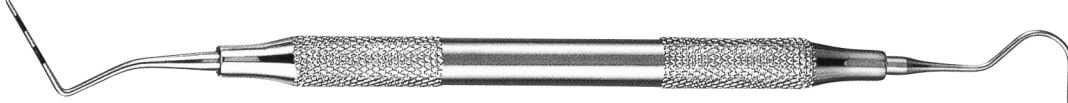

06-0821-CP12/23
FIG. CP12 / 23

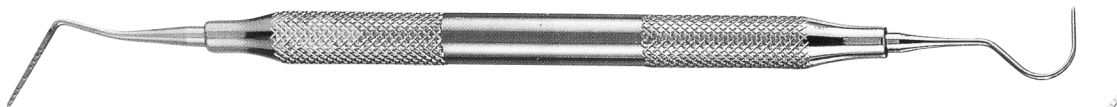

06-0822-GF/23
FIG. GF / 23

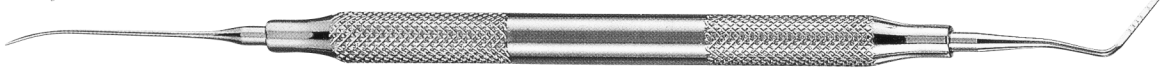

06-0823-GF/3
FIG. GF / 3

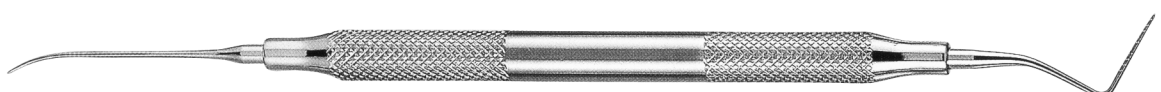

06-0824-UM/3
FIG. UM / 3

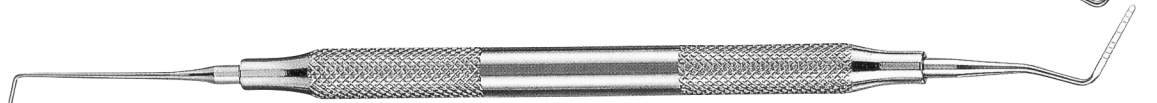

06-0825-GF/6
FIG. GF / 6

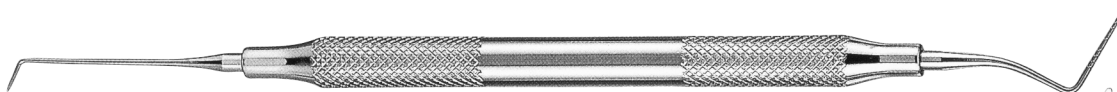

06-0826-W/6
FIG. W / 6

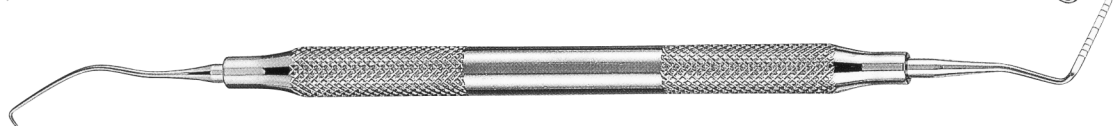

06-0827-GF/17
FIG. GF / 17

ALL ABOVE PRODUCTS ARE ALSO AVAILABLE WITH HOLLOW HANDLES

DIAGNOSTIC INSTRUMENTS AND SPATULAS

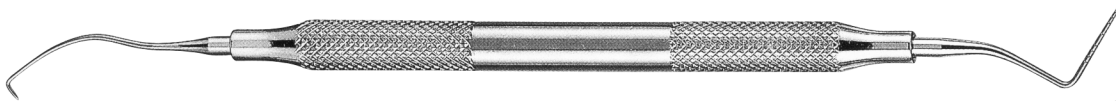

06-0828-W/17
FIG. W / 17

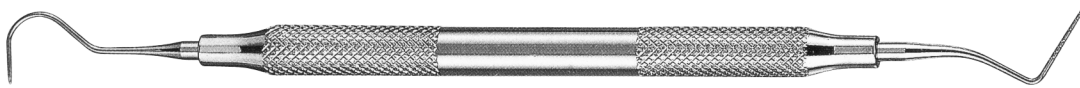

06-0829-GF/23
FIG. GF / 23

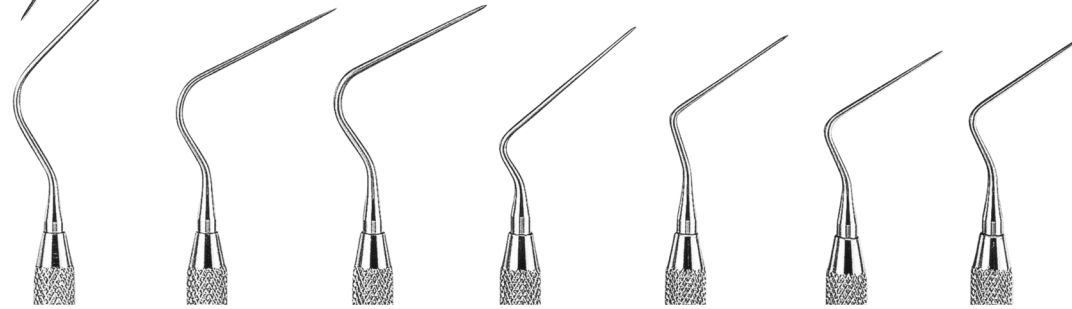
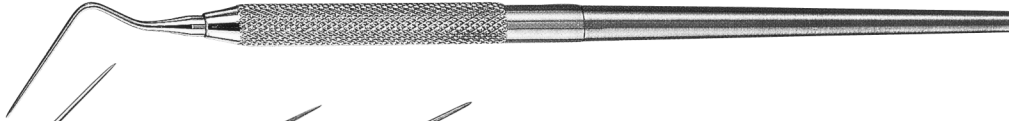

06-0830-00
SPREADER

06-0831-00
SPREADER

06-0832-00
SPREADER

06-0833-00
SPREADER

06-0834-00
SPREADER

06-0835-00
SPREADER

06-0836-00
SPREADER



06-0837-00
PLUGGER



06-0838-00
PLUGGER



06-0839-00
PLUGGER



06-0840-00
PLUGGER

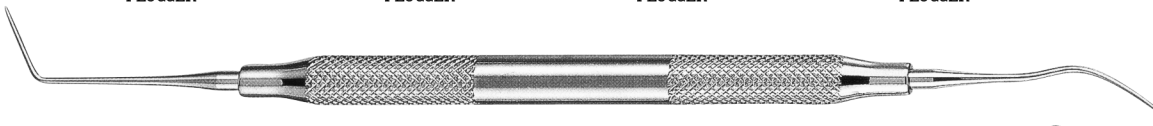

06-0841-W/23
FIG. W / 23

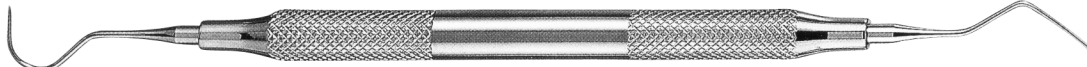

06-0842-23/17
FIG. 23 / 17

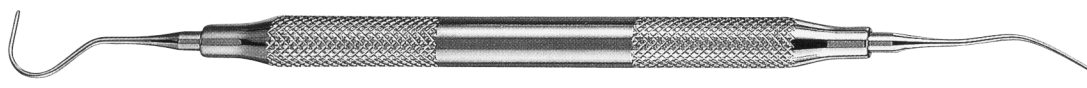

06-0843-00

CEMENT SPATULAS



06-0844-00



06-0845-00



06-0846-00













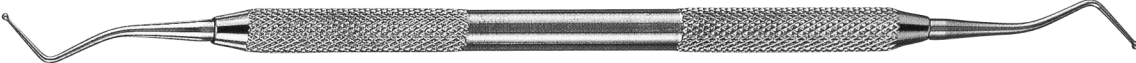
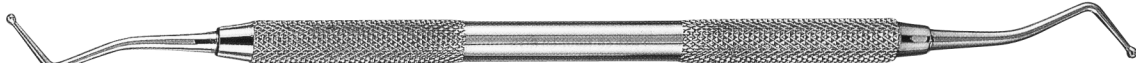

06-0847-00

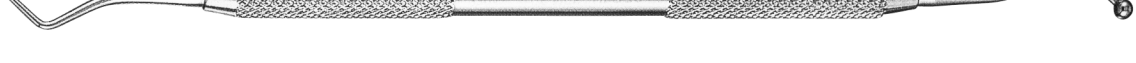
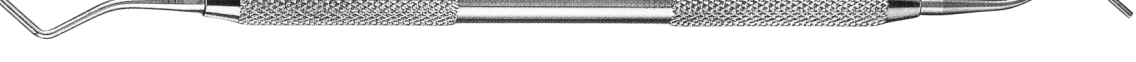
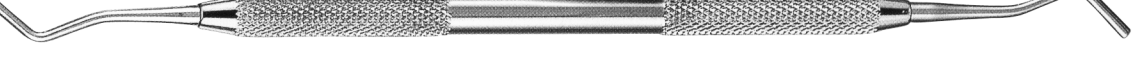
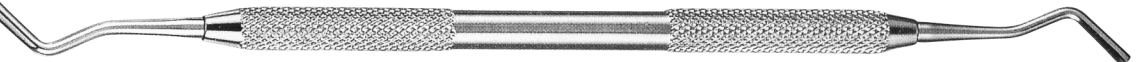

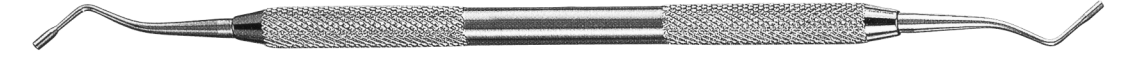
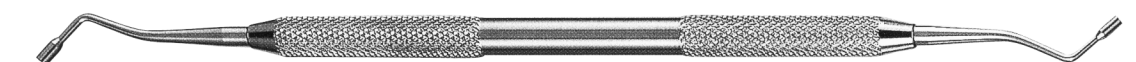
06-0848-00

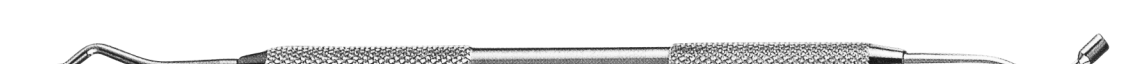
ALL ABOVE PRODUCTS ARE ALSO AVAILABLE WITH HOLLOW HANDLES

AMALGAM INSTRUMENTS

	06-0849-1 FIG. 1
	06-0850-2 FIG. 2
	06-0851-3 FIG. 3
	06-0852-4 FIG. 4
	06-0853-5 FIG. 5
	06-0854-1L FIG. 1L (SMOOTH TIPS)
	06-0855-2L FIG. 2L (SMOOTH TIPS)
	06-0856-3L FIG. 3L (SMOOTH TIPS)
	06-0857-1L FIG. 1L (SMOOTH TIPS)
	06-0858-2L FIG. 2L (SMOOTH TIPS)
	06-0859-3L FIG. 3L (SMOOTH TIPS)
	06-0860-4L FIG. 4L (SMOOTH TIPS)
	06-0861-1 FIG. 1
	06-0862-2 FIG. 2
	06-0863-3 FIG. 3
	06-0864-1 WESTCOTT FIG. 1
	06-0865-2 WESTCOTT FIG. 2

ALL ABOVE PRODUCTS ARE ALSO AVAILABLE WITH HOLLOW HANDLES

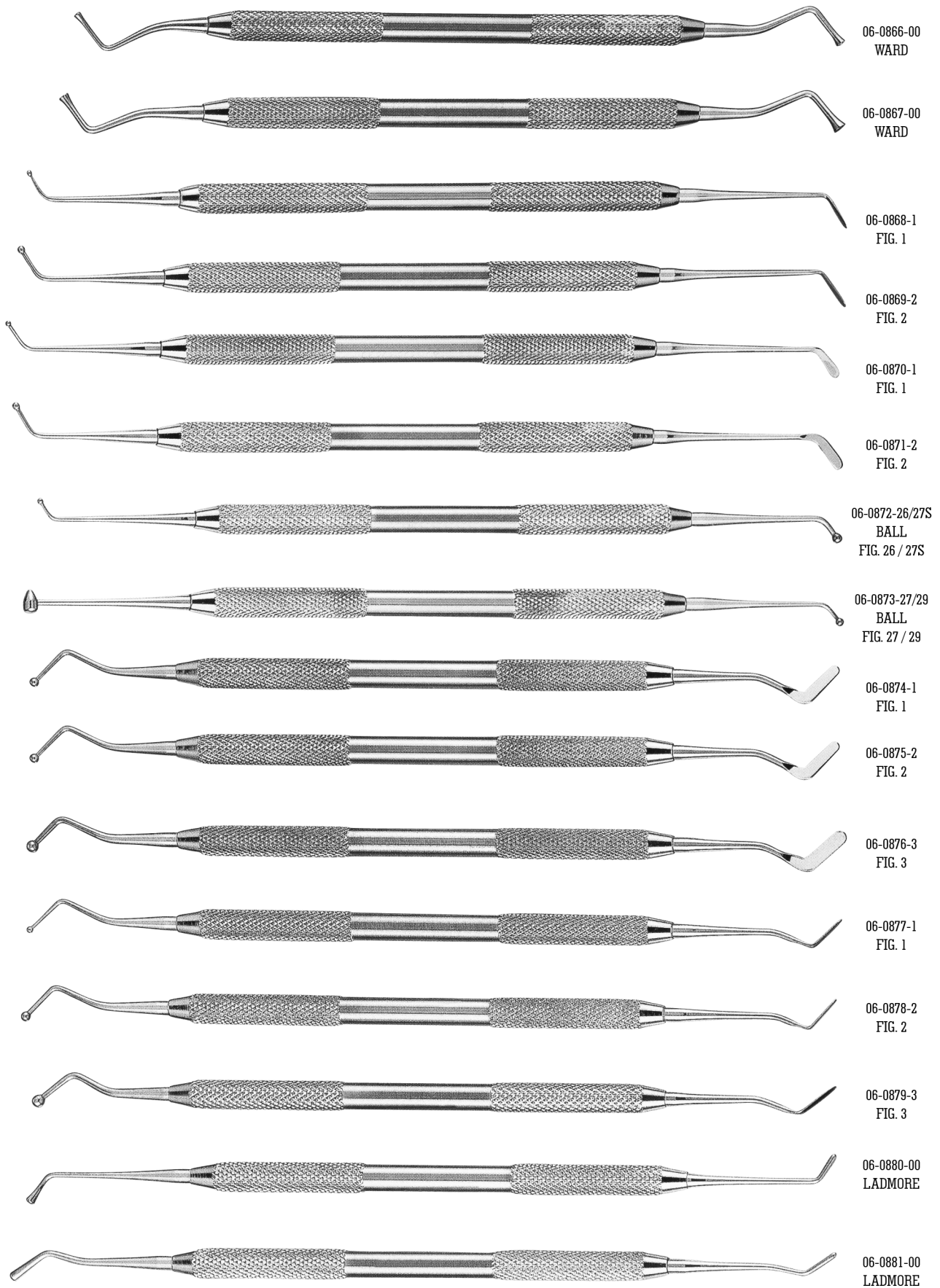

ALL ABOVE PRODUCTS ARE ALSO AVAILABLE WITH HOLLOW HANDLES

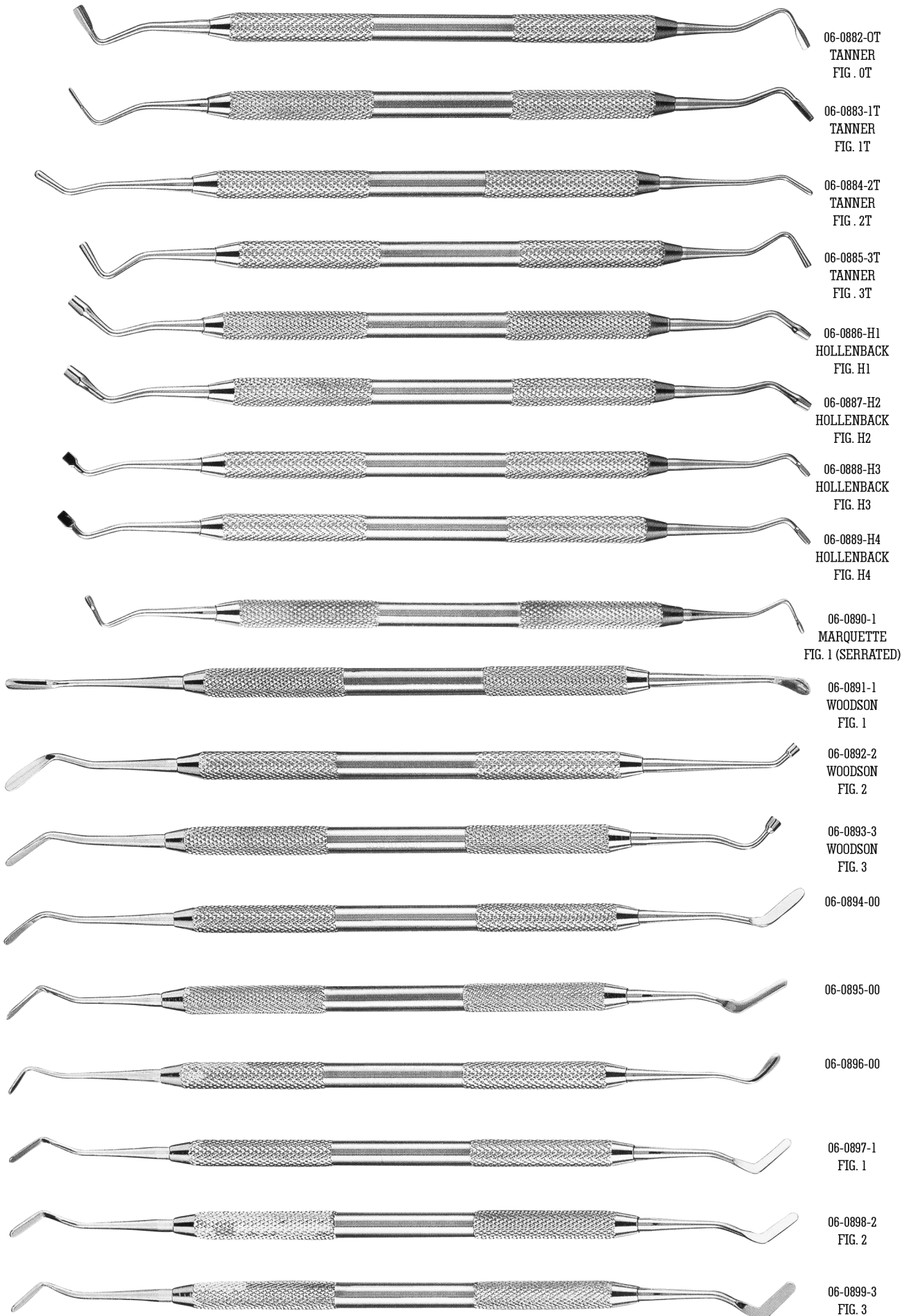

ALL ABOVE PRODUCTS ARE ALSO AVAILABLE WITH HOLLOW HANDLES

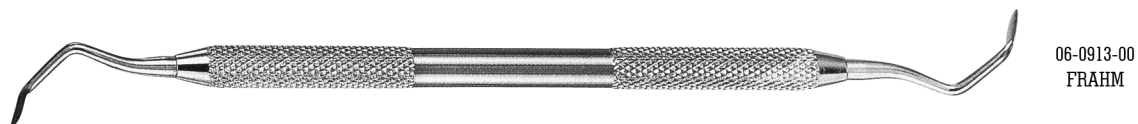
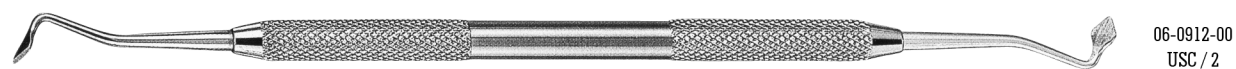
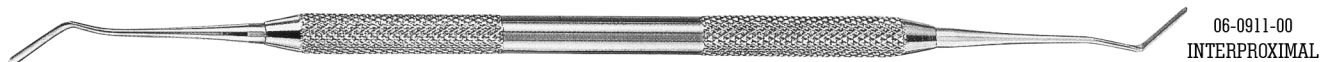
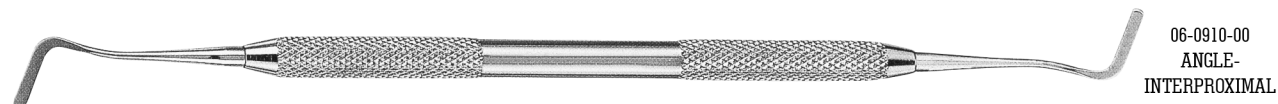
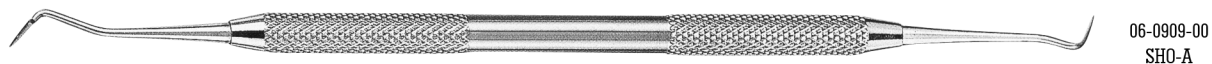
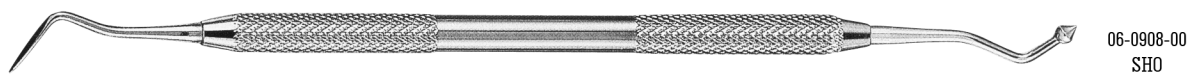
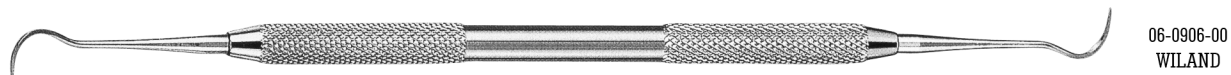
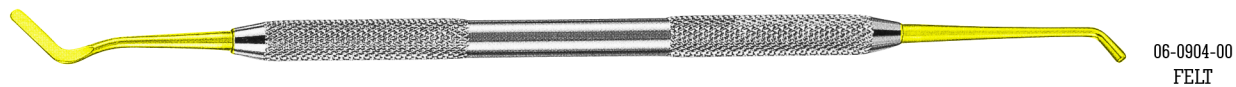
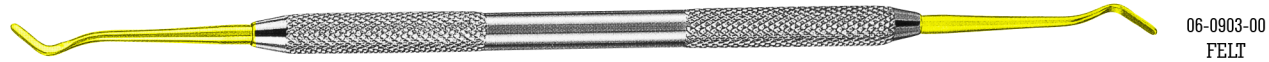
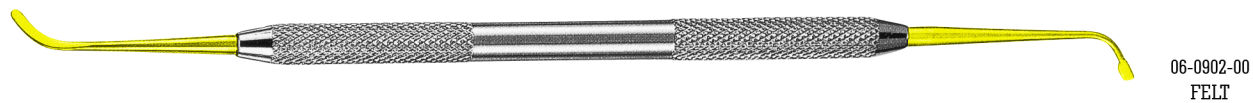
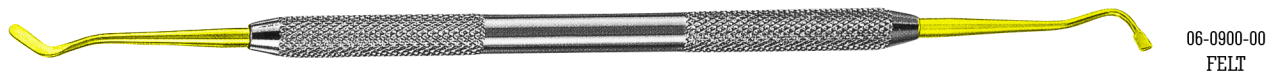

ALL ABOVE PRODUCTS ARE ALSO AVAILABLE WITH HOLLOW HANDLES

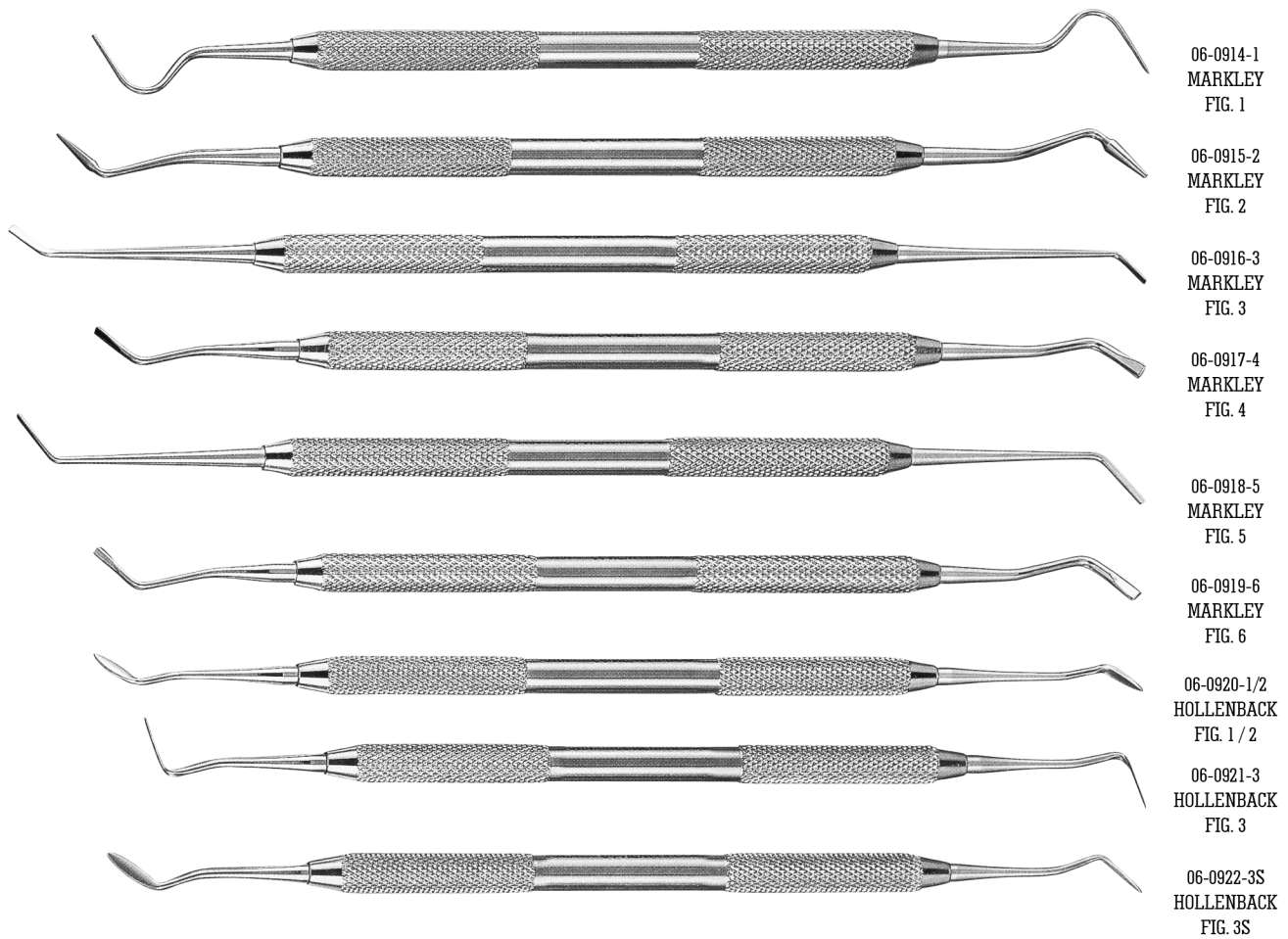

AMALGAM CARVERS



ALL ABOVE PRODUCTS ARE ALSO AVAILABLE WITH HOLLOW HANDLES

TRIMMERS, CAVITY PREPARATION AND EXCAVATORS

GINGIVAL MARGIN TRIMMERS

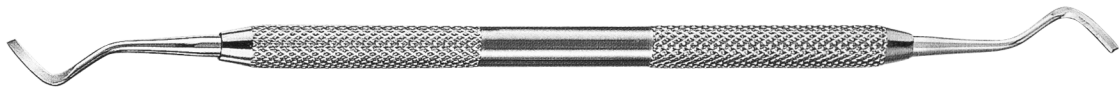

06-0930-26
BLACK 26
(DISTAL)

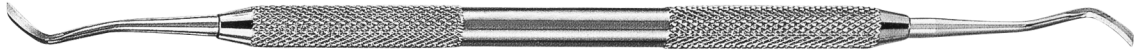

06-0931-27
BLACK 27
(MESIAL)

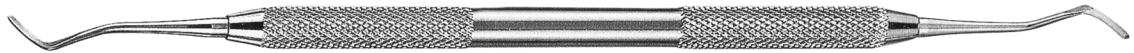

06-0932-28
BLACK 28
(DISTAL)

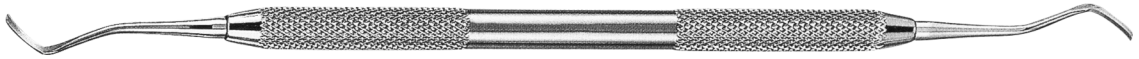

06-0933-29
BLACK 29
(MESIAL)



06-0934-77 / 78
BLACK 77 / 78
(DISTAL)



06-0935-79 / 80
BLACK 79 / 80
(MESIAL)

CAVITY PREPARATION

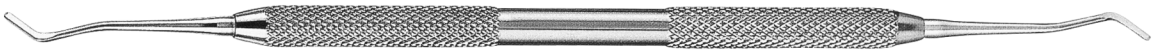

06-0936-53 / 54
BLACK 53 / 54

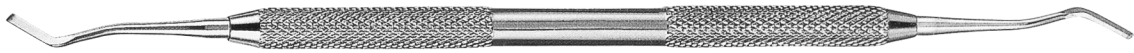

06-0937-51 / 52
BLACK 51 / 52

EXCAVATORS

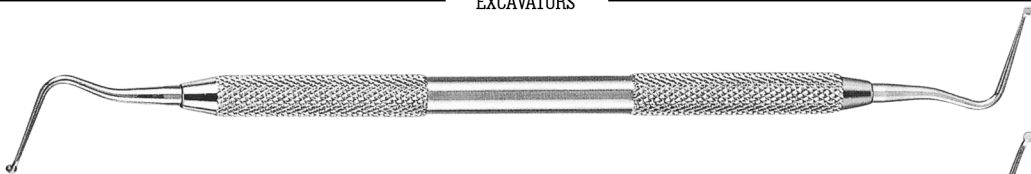

06-0938-1
FIG. 1



06-0939-2
FIG. 2



06-0940-4
FIG. 4

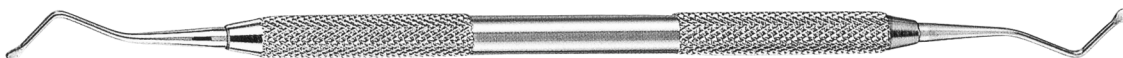

06-0941-3
FIG. 3

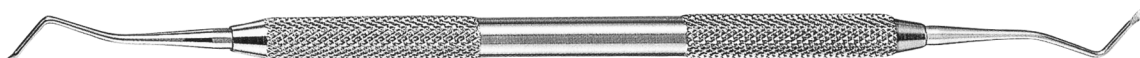

06-0942-2
FIG. 2

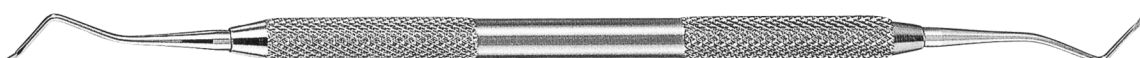

06-0943-1
FIG. 1



06-0944-0
FIG. 0

ALL ABOVE PRODUCTS ARE ALSO AVAILABLE WITH HOLLOW HANDLES

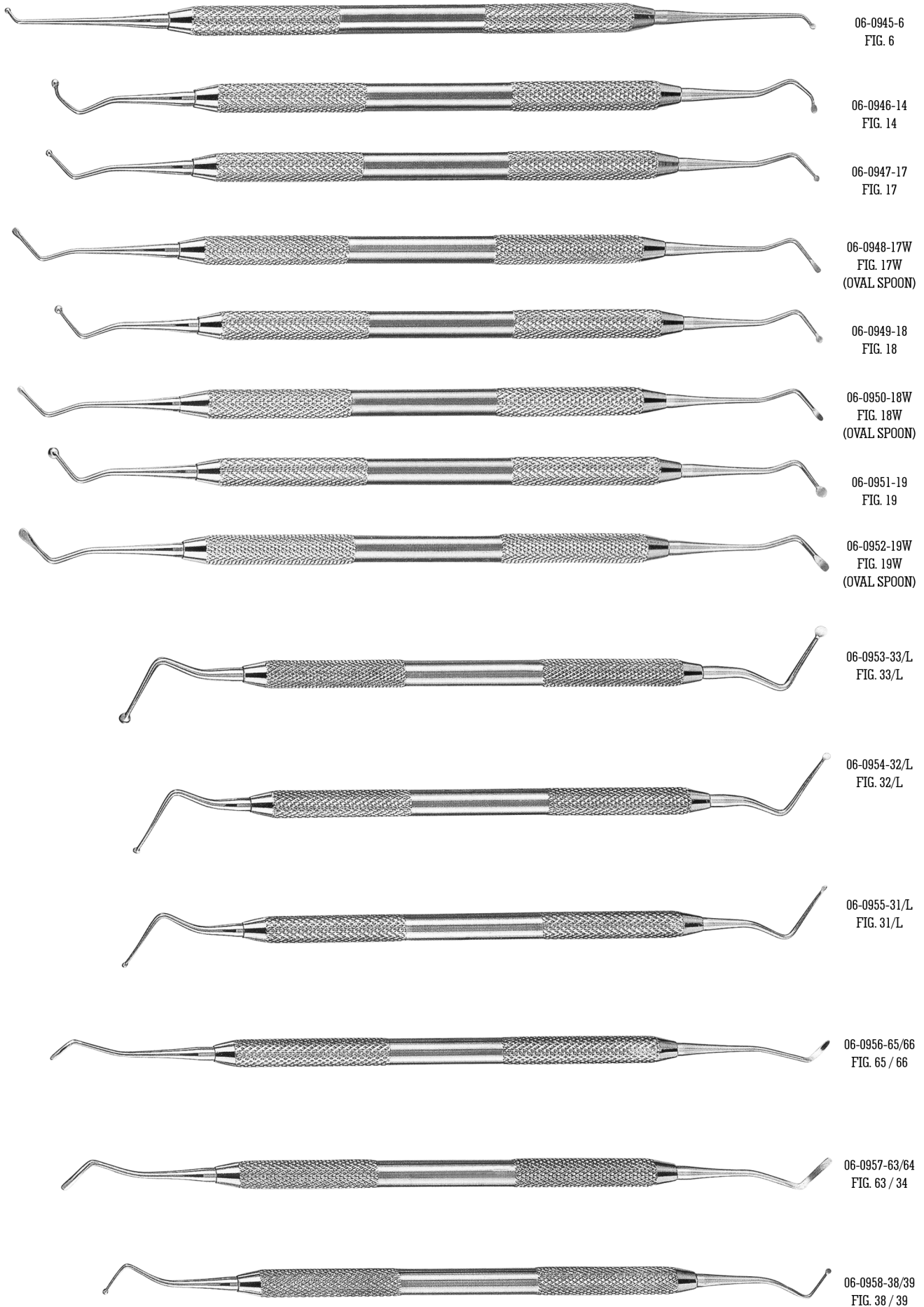

ALL ABOVE PRODUCTS ARE ALSO AVAILABLE WITH HOLLOW HANDLES



06-0959-17
IVORY
17cm



06-0960-17
AINSWORTH
17cm

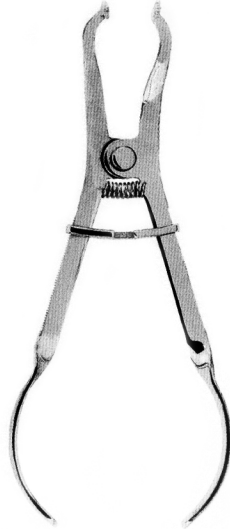

06-0961-17
IVORY (Light weight)
17cm

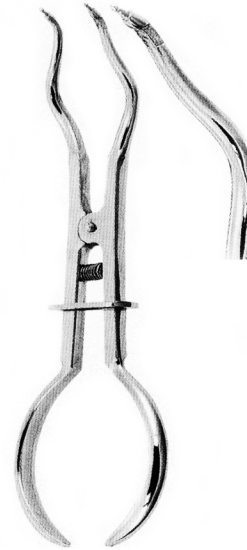

06-0962-175
BREWER
17.5cm

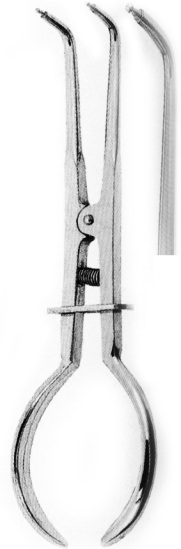

06-0963-175
STOKE
17.5cm



06-0964-155
(Separating Pliers)
15.5cm



MOLT
06-0965-11 11cm
06-0966-14 14cm



ROSER-KOENIG
06-0967-16 16cm
06-0968-19 19cm



06-0969-12
HEISTER
12cm

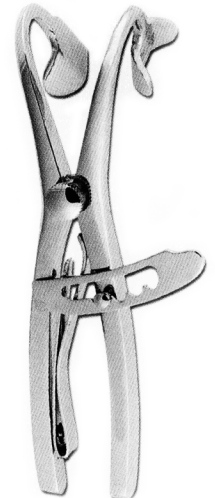

06-0970-12
DENHART
12cm



06-0971-16
16cm



06-0972-12
12cm



06-0973-16
16cm



06-0974-16
16cm



06-0975-16
16cm



06-0976-16
16cm



06-0977-16
16cm



06-0978-16
16cm



06-0979-16
16cm



06-0980-16
16cm

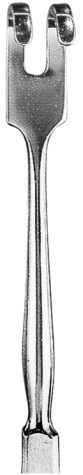

06-0981-16
16cm

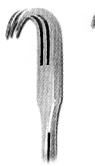

06-0982-16
Sharp



06-0983-16
Blunt



06-0984-18



06-0985-18



06-0986-13

06-0987-13

06-0986-13 & 06-0987-13
WILLIGER
13cm

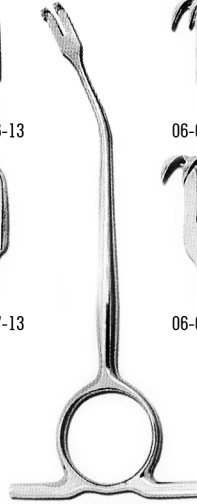

06-0988-13

06-0989-13

06-0988-13 & 06-0989-13
WILLIGER
13cm

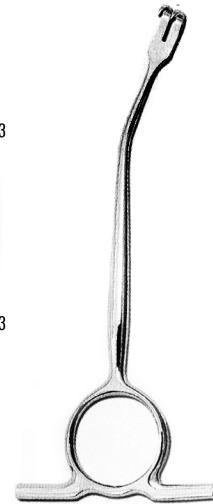

06-0990-13

06-0991-13

06-0990-13 & 06-0991-13
WILLIGER
13cm

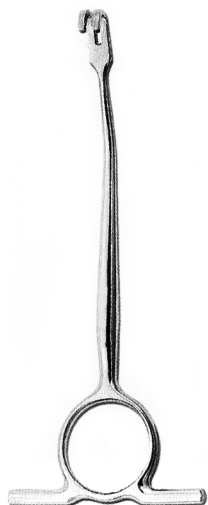

06-0992-13 & 06-0993-13
WILLIGER
13cm



06-0992-13

06-0993-13

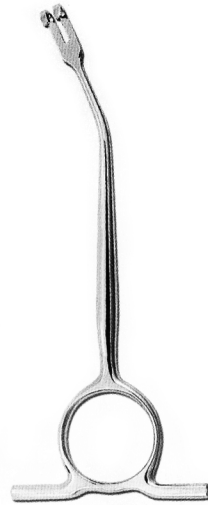

06-0994-13 & 06-0995-13
WILLIGER
13cm



06-0994-13

06-0995-13

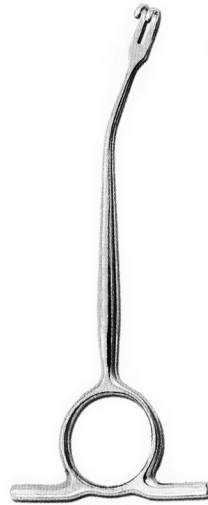

06-0996-13 & 06-0997-13
WILLIGER
13cm



06-0996-13

06-0997-13



06-0998-13
FARABEUF
13cm



06-0999-15
KILNER
15cm

ALL ABOVE PRODUCTS ARE ALSO AVAILABLE WITH HOLLOW HANDLES

RETRACTORS & ANTRUM PROBES

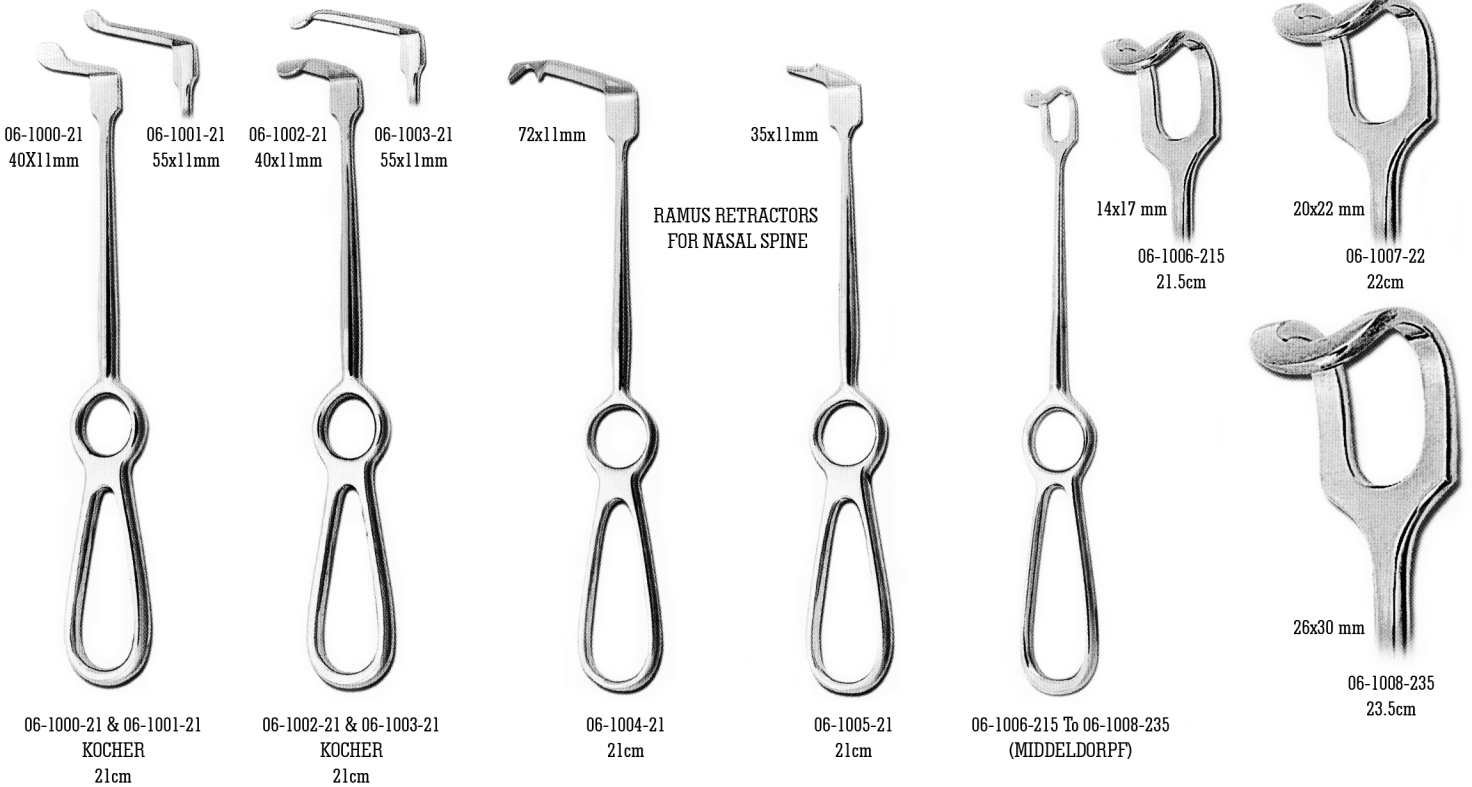

ANTRUM PROBES

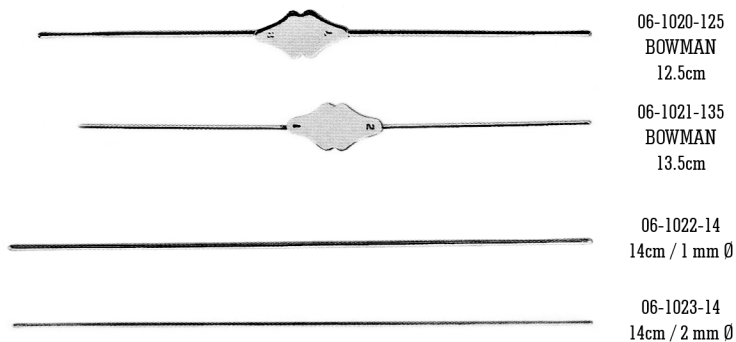

06-1024-235
23.5cm
(LABIAL RETRACTOR)

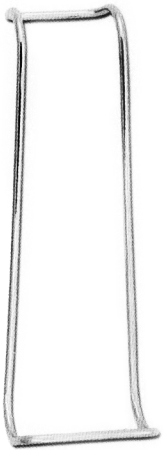

06-1025-145
COLUMBIA
14.5cm



06-1026-14
STERNBERG
14cm



06-1027-16
STERNBERG
16cm



06-1028-14
STERNBERG
14cm



06-1029-00
ORINGER-Medium
11x8cm



06-1030-14
UNIVERSITY OF MINNESOTA
14cm



06-1031-145
14.5cm



06-1032-145
BUCHWALD
14.5cm



06-1033-17
BUCHWALD
17cm



06-1034-19
BRUNING
19cm



06-1035-16
COLLIN
16cm



06-1036-17
YOUNG
17cm

ALL ABOVE PRODUCTS ARE ALSO AVAILABLE WITH HOLLOW HANDLES

MIRROR HANDLES, MIRRORS AND MEASURING INSTRUMENTS

ALL HANDLES ARE AVAILABLE IN EUROPEAN AND AMERICAN THREADS

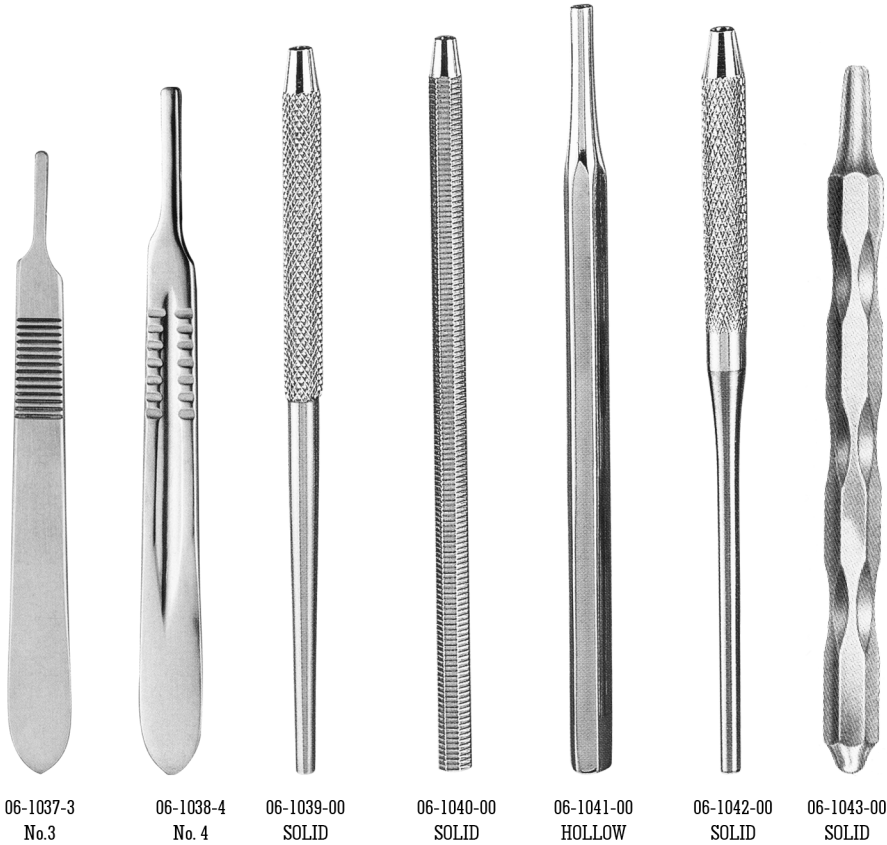

AVAILABLE IN PLAIN AND
MAGNIFYING SHAPES

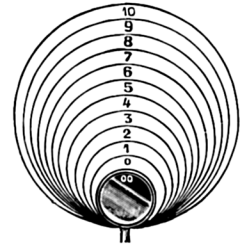

- 06-1044-00 Fig. 00 = 8 mm Ø
- 06-1045-00 Fig. 0 = 10 mm Ø
- 06-1046-00 Fig. 1 = 12 mm Ø
- 06-1047-00 Fig. 2 = 14 mm Ø
- 06-1048-00 Fig. 3 = 16 mm Ø
- 06-1049-00 Fig. 4 = 18 mm Ø
- 06-1050-00 Fig. 5 = 20 mm Ø
- 06-1051-00 Fig. 6 = 22 mm Ø
- 06-1052-00 Fig. 7 = 24 mm Ø
- 06-1053-00 Fig. 8 = 26 mm Ø
- 06-1054-00 Fig. 9 = 28 mm Ø
- 06-1055-00 Fig. 10 = 30 mm Ø

06-1056-00
PACK OF TWELVE Pcs.
(06-1044-00 TO 06-1055-00)

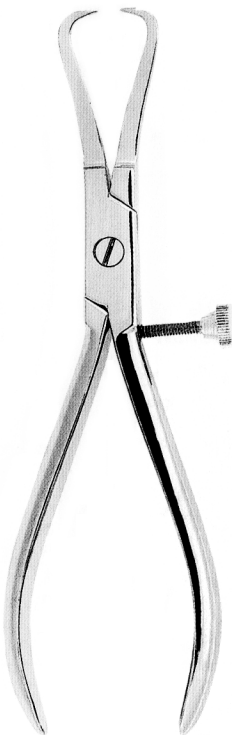

06-1057-00
FURRER
16cm (Straight)

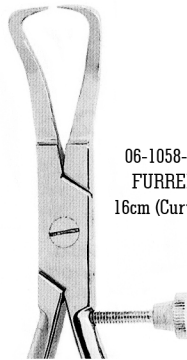

06-1058-00
FURRER
16cm (Curved)



06-1059-00
IWANSON
0-10 mm
(MEASUREMENT)



06-1060-00
IWANSON
0-10 mm
(MEASUREMENT)



06-1061-00



06-1062-00



HYLIN
06-1063-00



HYLIN-CERAMICA
06-1064-00



HYLIN-CRAN
06-1065-00



ZAHLE
06-1066-00



ZAHLE
06-1067-00



ZAHLE
06-1068-00



LE-CRAN
06-1069-00



LE-CRAN
06-1070-00



LE-CRAN
06-1071-00



LE-CRAN
06-1072-00

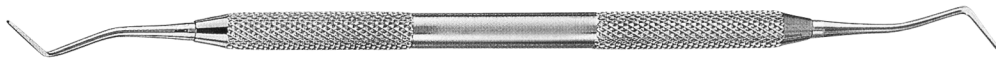

HOLLENBACK
06-1073-00

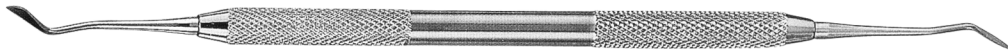

HOLLENBACK
06-1074-00

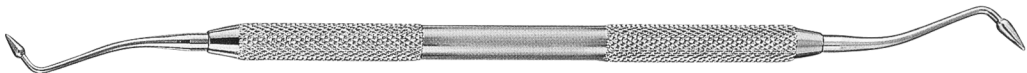

P.K.THOMAS
06-1075-00



P.K.THOMAS
06-1076-00



P.K.THOMAS
06-1077-00



06-1078-16 16 cm
06-1079-165 16.5 cm

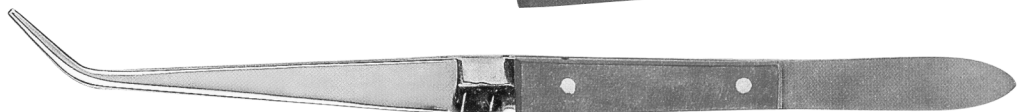



06-1080-17
GRITMAN
17cm



06-1081-17
LESSMANN
17cm



06-1082-17
17cm



06-1083-125
LESSMANN
12.5cm



06-1084-125
12.5cm



06-1085-17
FAHNENSTOCK
17cm



06-1086-125
FAHNENSTOCK
12.5cm



06-1087-17
17cm



06-1088-215
21.5cm

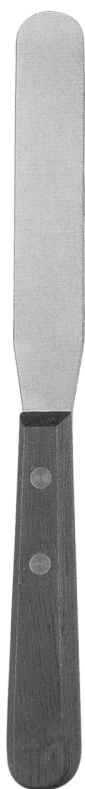

06-1089-205
20.5cm

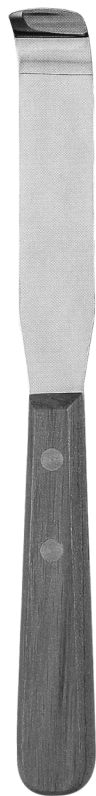

06-1090-195
19.5cm



06-1091-225
22.5cm

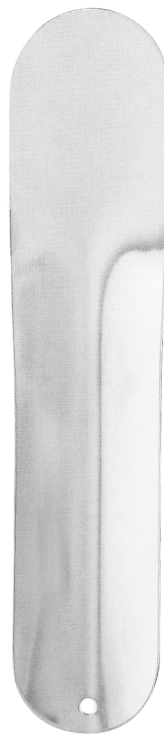

06-1092-185
18.5cm



06-1093-195
19.5cm



06-1094-00
GRITMAN



06-1095-00



Lotion Bowl Without Spout

- 06-1096-00 40x19mm Cap. 0.03Ltr
- 06-1097-00 50x25mm Cap. 0.035Ltr
- 06-1098-00 60x30mm Cap. 0.06Ltr
- 06-1099-00 80x40mm Cap. 0.10Ltr
- 06-1100-00 100x50mm Cap. 0.25Ltr
- 06-1101-00 120x60mm Cap. 0.50Ltr
- 06-1102-00 140x60mm Cap. 0.60Ltr
- 06-1103-00 150x65mm Cap. 0.70Ltr
- 06-1104-00 180x85mm Cap. 1.6Ltr
- 06-1105-00 200x100mm Cap. 2.00Ltr
- 06-1106-00 250x120mm Cap. 5.00Ltr
- 06-1107-00 300mm
- 06-1108-00 350mm
- 06-1109-00 400mm



Kidney Tray Without Lid

- 06-1110-00 120mm
- 06-1111-00 150mm, 150ml
- 06-1112-00 150x85x30mm
- 06-1113-00 170mm
- 06-1114-00 200x95x40mm
- 06-1115-00 240x105x45mm
- 06-1116-00 280x120x50mm, 1000ml
- 06-1117-00 300mm, 1200ml



Sterilising Cassette With Silicon Inserts
For 10 Instruments
Removable Top, 18x13x2.5cm
06-1118-00



Sterilising Tray Perforated Lid
With Rack & Lid
28x18x2.5
06-1119-00



Test-Tube Rack
06-1120-00 12Tubes
06-1121-00 24Tubes
06-1122-00 40Tube



Cotton Holding Jar
06-1025-00 60x50
06-1026-00 60x50
06-1027-00 Methot, 50x75mm



Endo Box
With Cover
06-1123-00



Endo Box Round
With Cover
06-1124-00



- Sterilising Drum
- 06-1128-00 125 x 100mm
 - 06-1129-00 125 x 125mm
 - 06-1130-00 150 x 100mm
 - 06-1131-00 150 x 150mm
 - 06-1132-00 180 x 180mm
 - 06-1133-00 190 x 150mm
 - 06-1134-00 190 x 190mm
 - 06-1135-00 200 x 200mm
 - 06-1136-00 240 x 120mm
 - 06-1137-00 240 x 165mm
 - 06-1138-00 240 x 190mm
 - 06-1139-00 240 x 240mm
 - 06-1140-00 240 x 290mm
 - 06-1141-00 290 x 145mm
 - 06-1142-00 290 x 240mm
 - 06-1143-00 290 x 290mm
 - 06-1144-00 300 x 300mm
 - 06-1145-00 325 x 150mm
 - 06-1146-00 340 x 240mm
 - 06-1147-00 340 x 290mm
 - 06-1148-00 340 x 340mm
 - 06-1149-00 390 x 190mm
 - 06-1150-00 390 x 290mm
 - 06-1151-00 370 x 340mm
 - 06-1152-00 390 x 390mm



Needle Case Without Cover
06-1122-00 90 x 15 mm



Needle Case With Cover
06-1123-00 65 x 15 mm
06-1124-00 90 x 15 mm

HOLLOW WARE



Sprit Lamp
06-1153-050 50cc
06-1154-100 100cc
06-1155-100 120cc
06-1156-500 500cc
06-1157-000
with three lamps of 100cc



Sprit Lamp
Stainless Steel
06-1158-100 100ccc



Dressing Jar With Lid
06-1159-800 80 x 60mm
06-1160-800 80 x 80mm
06-1161-100 100 x 100mm
06-1162-110 110 x 140mm
06-1163-1120 120 x 120mm
06-1164-150 150 x 150mm
06-1165-200 180 x 180mm
06-1166-200 200 x 200mm



Instrument Tray Without Lid
06-1167-1150 150x100x30mm
06-1168-1170 170x110x25mm
06-1169-200 200x100x50mm
06-1170-200 200x130x25mm
06-1171-220 220x170x15mm
06-1172-1220 220x150x30mm
06-1173-220 220x150x50mm
06-1174-250 250x200x50mm
06-1175-280 280x180x30mm
06-1176-300 300x150x100mm
06-1177-300 300x210x40mm
06-1178-300 300x250x50mm
06-1179-350 350x260x40mm
06-1180-350 350x300x50mm
06-1181-400 400x200x50mm
06-1182-400 400x300x50mm
06-1183-430 430x180x50mm
06-1184-450 450x300x100mm



Instrument Tray With Lid
06-1185-150 150x100x30mm
06-1186-170 170x110x25mm
06-1187-200 200x100x50mm
06-1188-200 200x130x25mm
06-1189-220 220x170x15mm
06-1190-220 220x150x30mm
06-1191-220 220x150x50mm
06-1192-250 250x200x50mm
06-1193-280 280x180x30mm
06-1194-300 300x150x100mm
06-1195-300 300x210x40mm
06-1196-300 300x250x50mm
06-1197-350 350x260x40mm
06-1198-350 350x300x50mm
06-1199-400 400x200x50mm
06-1200-400 400x300x50mm
06-1201-430 430x180x50mm
06-1202-450 450x300x100mm



Mayo Utility Tray
06-1203-255 255x165x18mm
06-1204-345 345x245x16mm
06-1205-385 385x265x16mm
06-1206-430 430x295x16mm
06-1207-480 480x330x20mm
06-1208-540 540x415x20mm
06-1209-540 540x420x30mm
06-1210-700 700x450x30mm



Perforated Tray
06-1211-150 150x100x30mm
06-1212-200 200x100x50mm
06-1213-220 220x150x50mm
06-1214-250 250x200x50mm
06-1215-270 270x270x50mm
06-1216-300 300x150x100mm
06-1217-300 300x250x50mm
06-1218-350 350x300x50mm
06-1219-400 400x200x50mm
06-1220-400 400x300x50mm
06-1221-430 430x180x50mm
06-1222-450 450x300x100mm



Instrument Box With Cover And Hooks
06-1223-140 140x80x40mm
06-1224-180 180x60x30mm
06-1225-170 170x70x30mm
06-1226-180 180x80x40mm
06-1227-200 200x100x40mm
06-1228-200 200x100x50mm
06-1229-220 220x120x50mm
06-1230-220 220x150x50mm
06-1231-250 250x150x50mm
06-1232-300 300x150x50mm
06-1233-300 300x180x50mm
06-1234-340 340x165x50mm
06-1235-400 400x200x50mm
06-1236-400 400x300x100mm
06-1237-450 450x300x50mm
06-1238-500 500x210x100mm
06-1239-500 500x210x120mm



Instrument Box With Cover
06-1240-160 160x80x30mm
06-1241-170 170x70x30mm
06-1242-180 180x60x30mm
06-1243-180 180x80x40mm
06-1244-200 200x100x40mm
06-1245-200 200x100x50mm
06-1246-200 200x100x60mm
06-1247-220 220x120x50mm
06-1248-220 220x150x50mm
06-1249-230 230x130x55mm
06-1250-230 230x150x55mm
06-1251-1250 250x100x50mm
06-1252-1250 250x150x50mm
06-1253-1250 250x130x60mm
06-1254-220 250x200x60mm
06-1255-290 290x140x60mm
06-1256-300 300x120x60mm
06-1257-1300 300x130x60mm
06-1258-300 300x150x50mm
06-1259-300 300x180x50mm
06-1260-300 300x200x60mm
06-1261-300 300x300x50mm
06-1262-300 300x300x100mm
06-1263-320 320x150x60mm
06-1264-330 330x280x60mm
06-1266-400 400x200x50mm
06-1267-400 400x200x90mm
06-1268-400 400x300x100mm
06-1269-420 420x180x70mm
06-1270-450 450x120x60mm
06-1271-1450 450x300x50mm
06-1272-500 500x210x100mm
06-1273-500 500x200x120mm
06-1274-575 575x275x130mm



Sterilising Perforated Box With Filter And Clamps
06-1275-004

A

Adson.....26, 31
Adson-TC.....31
Adson-Brown.....31
Adson-Brown-TC.....31
Ainsworth.....48
Allen.....07
Amalgam Carriers.....15
Amalgam Carvers.....45
Amalgam Instruments.....41
Angle-Interproximal.....44
Antrum Probes.....50
Apex.....11
Apical.....09
Arruga.....25
Arruga-TC.....25

B

Backhaus.....28
Ball.....42
Barnhart.....36
Baumgartner.....26
Beale.....07
Bein.....09, 11
Beyer.....04
Blumenthal.....04
Boucheron.....04-6
Bohler.....04
Bohm.....22
Bone Curettes.....32
Bone Files.....05
Bone Rongeurs.....04
Bowman.....50
Boynton.....25
Boynton-TC.....25
Brewer.....48
Bruning.....51
Buchwald.....51
Buck.....34
Buckley.....06

C

Cavity Preparation.....46
Castroviejo.....27
Castroviejo-TC.....27
Castroviejo Barraquer.....27
Cement Spatulas.....41
Chisels.....33
Chompret.....13
Cleoids-Discoids.....45
Cleveland.....04
Cleveland-Gardner.....04
Coleman.....11
College.....31
Collin.....51
Columbia.....36, 51
Cotton Holding Jars.....56
Crane-Kaplan.....34
Crane Pick.....09
Crile.....28
Crile-Wood.....26
Crile-Wood-TC.....26
Crown Instruments.....03
Cryer.....09, 11, 23
Curettes.....38
Curettes & Scalars.....33 - 37

D

De Marco.....35
Dean.....29
Dean-TC.....29
Denhart.....48
Dental Cartridge Syringes.....14
Derf.....26
Derf-TC.....26
Diagnostic Instruments.....38 - 40
Didner.....03
Distal.....46
Dressing Forceps.....28, 31
Dressing Jar.....56

E

Elevators.....08
Endo Boxes.....55
Excators.....46, 47
Extracting Forceps.....16 - 24
Extracting Forceps, American Pattern.....22, 23
Extracting Forceps For Children.....24
Extracting Forceps, Klein Pattern.....24
Extracting Forceps, Mead Pattern.....21

F

Fahnenstock.....54
Farabeuf.....49
Felt.....44
Files.....34
Filling Instruments.....41 - 45
Fine Swedish-TC.....25
Flagg.....31
Flohr.....09, 11
Frahm.....44
Freer.....07, 08
Friedman.....04
Furrer.....52

G

Gardner.....06
Gillies.....49
Gillies-TC.....25
Gingival Margin Trimmers.....46
Gingivectomy Knives.....33, 34
Goldman-Fox.....04, 07, 29, 31, 34, 37, 38
Goldman-Fox-TC.....50
Gracey.....33, 35, 36
Gracey Mesial Distal.....35
Gritman.....53, 54
Gross-Maire.....28

H

Haemostatic Forceps.....28
Halsey.....27
Halsey-Smooth.....27
Halstead-Mosquito.....28
Hartman.....28
Hegar-Baumgartner-TC.....26
Heidbrink.....10, 11, 13
Heidmann.....08
Heister.....48
Hemingway.....31
Herbert.....04
Hollenback.....45, 53
Hollow Ware.....55, 56
Hopkins.....07
Hourigan.....07
Howard.....05
Hull.....23
Hunter.....31
Hylin.....11, 53
Hylin-Ceramica.....53

I

Indiana University.....36
Interproximal.....44
Iris.....29
Instruments Box.....56
Instruments Box with cover.....56
Instruments Tray with lid.....56
Instruments Tray without lid.....56
Ivory.....03, 48
Ivory-Light Weight.....16
Iwanson.....52

J

Jones.....28

K

Kelly.....28, 29

Kelly-TC.....29
Kerrison.....04
Kidney Trays.....56
Kilner.....49
Kirkland.....33
Kocher.....28
Konig.....07
Kopp.....10

L

La Grange.....29
Labial Retractor.....50
Laboratory Instruments.....54
Ladmore.....42
Langer.....37
Le-Cran.....53
Lecluse.....13
Lengenbeck.....50
Lessmann.....53
Lichtenberg.....25
Lichtenberg-TC.....25
Lindo-Levien.....10, 12
Lip & Cheek Retractors.....51
Locklin.....30
Locklin-TC.....30
London Hospital.....11
Lotion Bowls.....55
Luer.....04

M

Mallets.....23
Matrix Retainers.....22
Markley.....45
Marquette.....43
Mathieu.....25
Mathieu-TC.....25
Mayo.....30
Mayo-Hegar.....26
Mayo-Hegar-TC.....26
Mayo Utility tray.....56
Mc Call.....37
Mead.....04, 07
Measuring Instruments.....52
Meriam.....31
Merit.....38
Mershon.....03
Metzenbaum.....30
Metzenbaum-Delicate.....30
Micro-Adson.....49
Micro-Adson-TC.....49
Micro-Barraquer-TC.....27
Micro-Mosquito.....28
Micro-Vascular-TC.....25
Middeldorpf.....50
Miller.....03, 05
Miller Apexo.....10, 11
Mini-Friedman.....04
Mini Ryder.....26
Mirrors.....52
Mirror Handles.....52
Modeling Carvers.....53
Molt.....07, 08, 48
Mouth Gags.....48

N

Nabers.....39
Needle Cases.....55
Needle Holders.....25 - 27
Neumann.....29
Navius.....23
Noyes.....30

O

Ochsenbein.....06, 33
Olsen-Hegar.....26
Orban.....33
Oringer-Medium.....51
Orthodontics.....08
Orthodontic Pliers.....01, 02



INDEX

P		W	
P.K.Thomas.....	53	Wahl.....	05
Partsch.....	04, 06, 07	Wakefield.....	06
Pean.....	28	Walter F. Barry.....	13
Perforated tray.....	56	Ward.....	45
Periodontal Instruments.....	06, 07, 32 - 37	Warwick-James.....	13
Periosteal Elevators.....	30	Wax Carvers.....	53
Perry.....	31	West.....	08
Pluggers.....	40	Westcott.....	30, 41
Polokoff.....	05	White.....	09
Pichard.....	07, 08	Wiland.....	44
Q		Williams.....	38
Quinby.....	29	Williger.....	49
R		Winnmann Crown TC.....	28
Retractors.....	48 - 50	Winter.....	13
Rhodens.....	33	Wire Cutters.....	01, 02
Root Elevators.....	09 - 13	Witzel.....	24
Root Splinter Forceps.....	24, 28	Woodson.....	43
Root Tip Pick.....	11, 13	Y	
Roser-Koenig.....	48	Young.....	51
Rubber Dam Instruments.....	48	Younger-Good.....	34
Ruskin-Mini.....	04	Z	
S		Zahle.....	53
Sanders.....	34	Zerfing Chisel.....	37
Scalers.....	32		
Schluger.....	34		
Schmeckebeer-Apexo.....	11		
Scissors.....	29, 30		
Seldin.....	07, 09, 11		
Semken-Taylor.....	31		
Senn-Miller.....	49		
Separating Pliers.....	48		
Separating Spatulas.....	30		
SHO.....	44		
Spatulas.....	08, 40		
Spencer.....	30		
Spirit Lamp.....	56		
Spreaders.....	40		
Stenberg.....	51		
Sterilising Box.....	56		
Sterilising Cassette.....	56		
Sterilising Perforated Tray.....	56		
Sterilising Tray.....	56		
Sterilising Drums.....	56		
Stevens.....	30		
Stieglitz.....	28		
Stoke.....	48		
Sullivan.....	30		
Sullivan-TC.....	30		
Syndesmotomes.....	13, 14		
Syringes.....	14		
T			
Tanners.....	43		
Taylor.....	34		
Test Tube Racks.....	56		
Tissue Forceps.....	31		
Toennis.....	25		
Toennis-TC.....	25		
Tofflemire.....	03		
Tomes.....	23		
Tongue Depressors.....	51		
Towner.....	35		
Towner Jaquette.....	35		
Trimmers.....	46		
U			
Universal.....	03, 30		
Universal-TC.....	30		
University of Michigan.....	38		
University of Minnesota.....	51		
USC-Towner.....	34		
V			
Virkers.....	04		



NANOTECH

TECHNOLOGY | PERCISION | SATISTACTION

NANOTECH
Toor Abad, Daska Road,
Sialkot - Pakistan
Tel / Fax: +92-52-3251119
email: info@nanotech.com.pk nanotech1100@gmail.com
web: www.nanotech.com.pk