

NANOTECH

TECHNOLOGY | PERCISION | SATISTACTION

02



Bone Holding Fcps, Bone Cutters & Rongeurs, Drills, Wire Extensions
Wire Cutters & Holders, Chissels, Gouges, Currettes , Hammers

PLASTER AND BANDAGE SHEARS

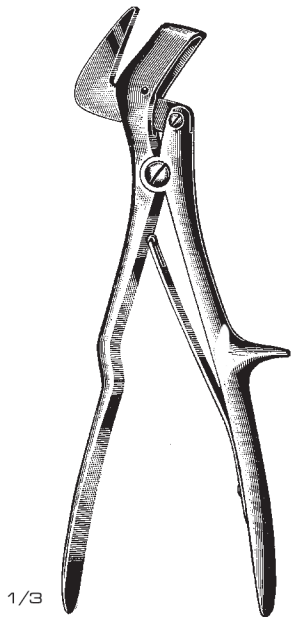

1/3
Stille
02-001-24
24 cm / 9½"

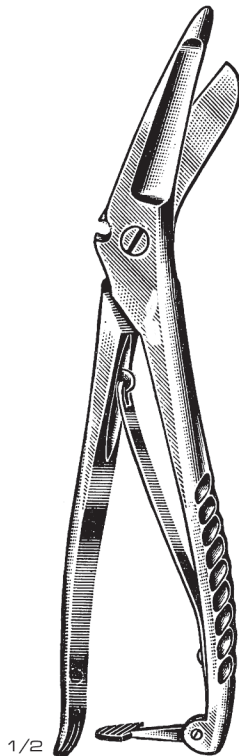

1/2
Commander
02-002-21
21 cm / 8¼"

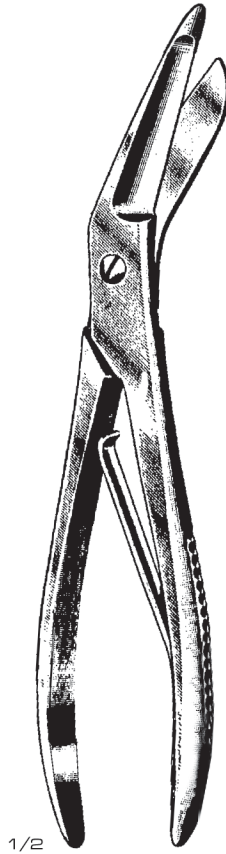

1/2
Seutin
02-003-21 21 cm / 8¼"
02-004-23 23 cm / 9"



Stille
02-005-23 23 cm / 9"
02-006-26 26 cm / 10¼"
02-007-37 37 cm / 14½"
02-008-42 42 cm / 16½"



Stille
02-009-23 23 cm / 9"
02-010-26 26 cm / 10¼"
02-011-37 37 cm / 14½"
02-012-42 42 cm / 16½"

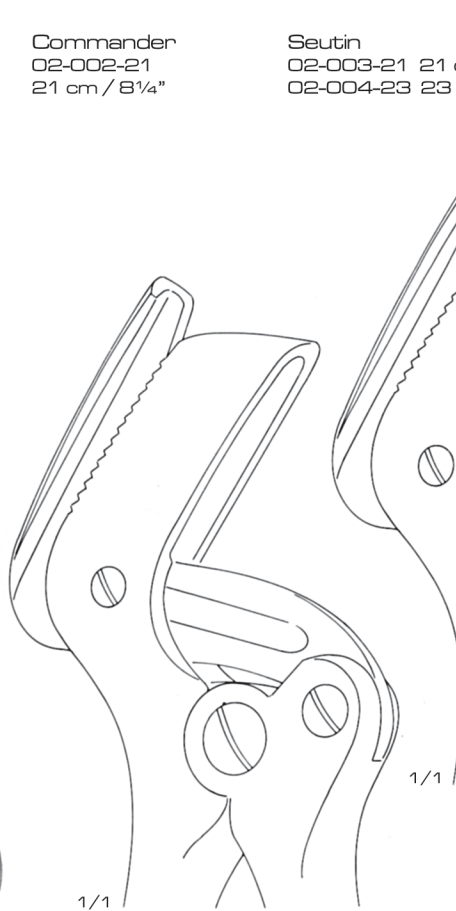

02-009-23
23 cm / 9"

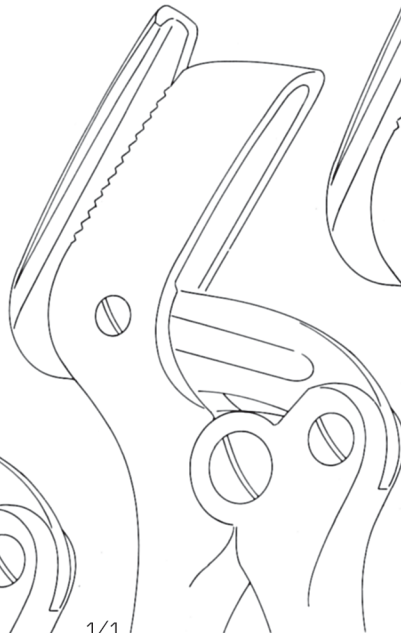

02-010-26
26 cm / 10¼"

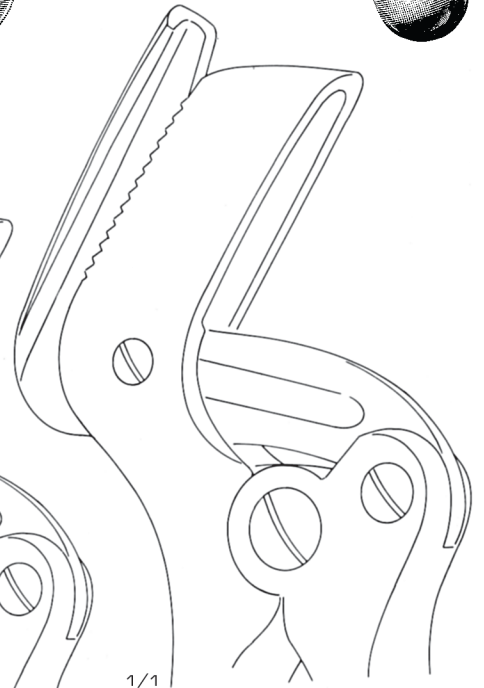

02-011-37
37 cm / 14½"

GOLD LINE

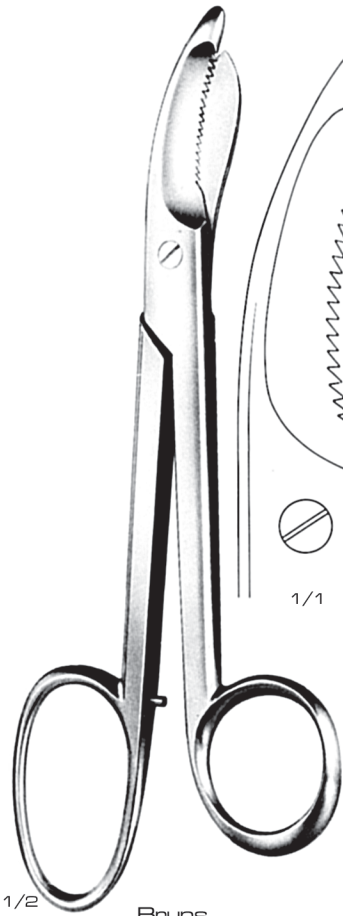

Bruns
02-013-24
24 cm / 9½"

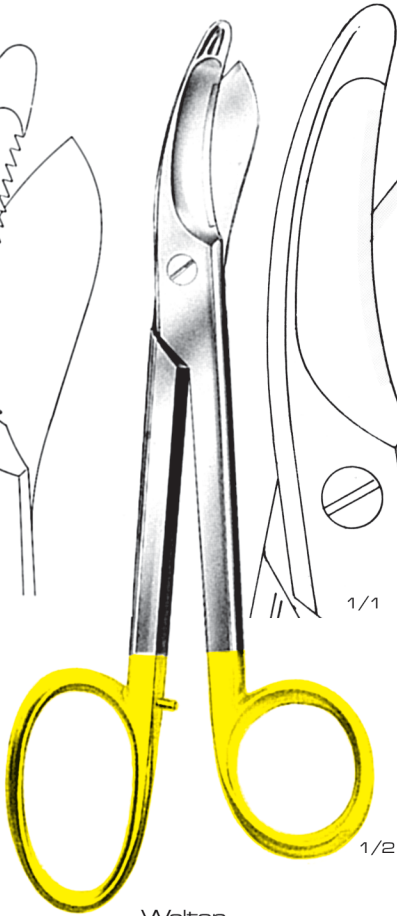

Walton
02-014-24
24 cm / 9½"



Lister
02-015-18
18 cm / 7"

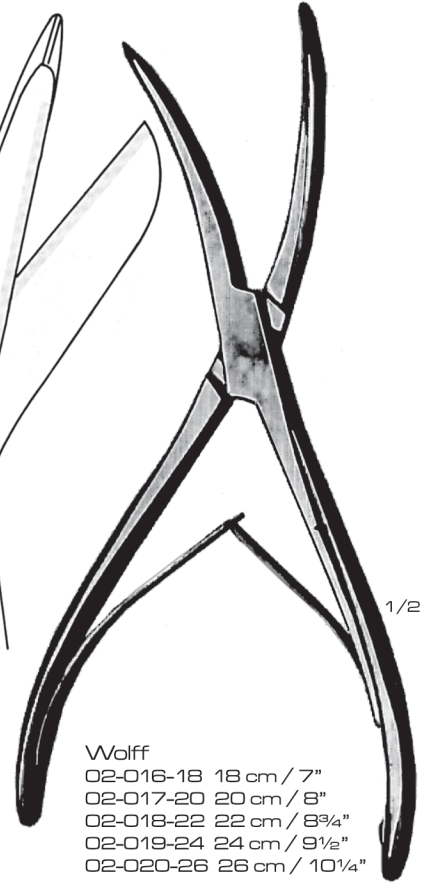

Wolff
02-016-18 18 cm / 7"
02-017-20 20 cm / 8"
02-018-22 22 cm / 8¾"
02-019-24 24 cm / 9½"
02-020-26 26 cm / 10¼"

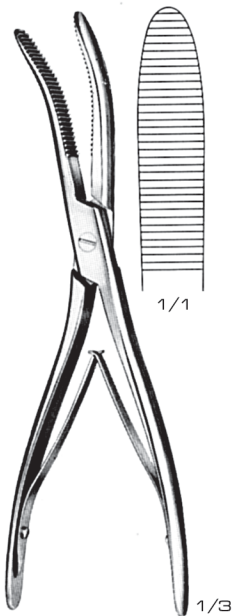

Wolff
02-021-18
18 cm / 7"

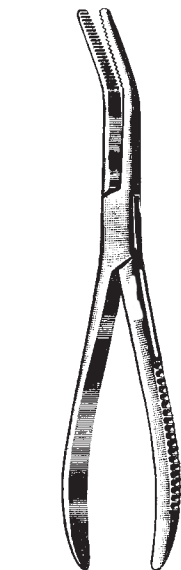

Farabeuf
02-022-18 18 cm / 7"
02-023-20 20 cm / 8"
02-024-24 24 cm / 9½"

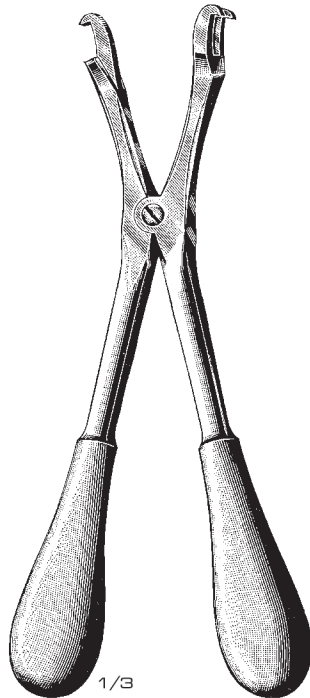

Haglund Stille
02-025-28
28 cm / 11"

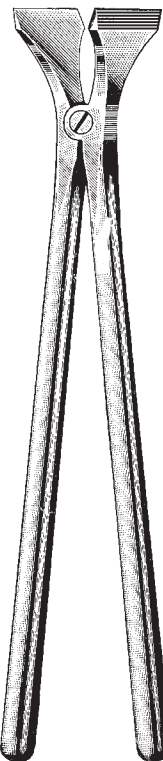

Beeson
02-026-30
30 cm / 12"

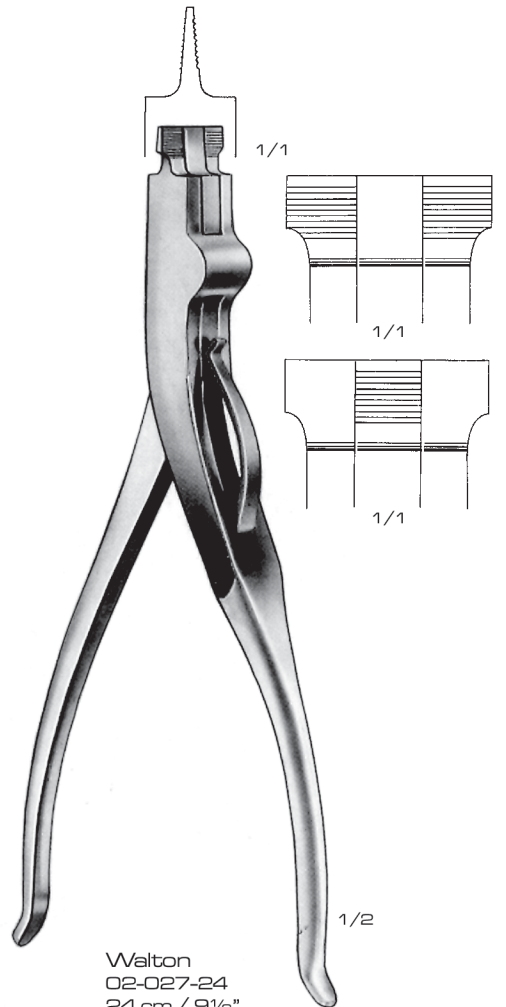

Walton
02-027-24
24 cm / 9½"



PLASTER SPREADERS AND AMPUTATION SAWS



Hennig
02-028-28 40 mm Jaws
02-029-28 60 mm Jaws
28 cm / 11"

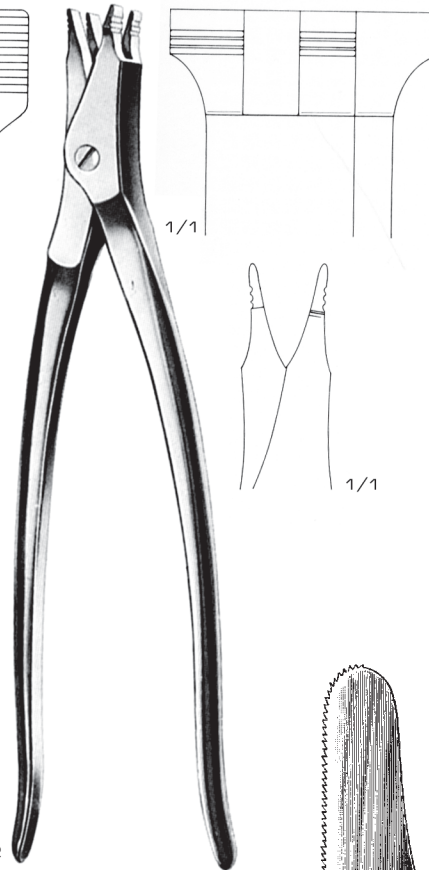

Quatro
02-030-23
23 cm / 9"

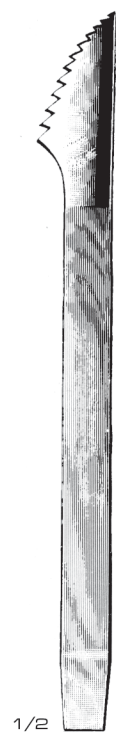

Wigmore
02-031-19
19 cm / 7 1/2"

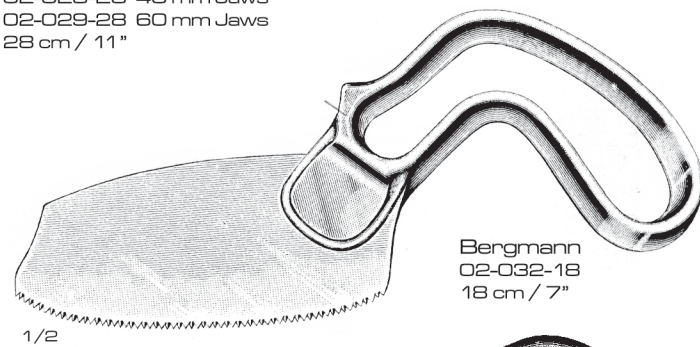

Bergmann
02-032-18
18 cm / 7"

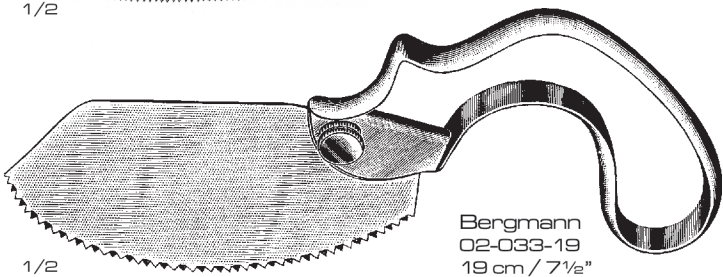

Bergmann
02-033-19
19 cm / 7 1/2"

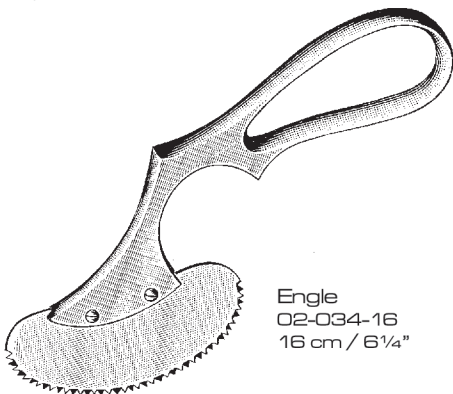

Engle
02-034-16
16 cm / 6 1/4"

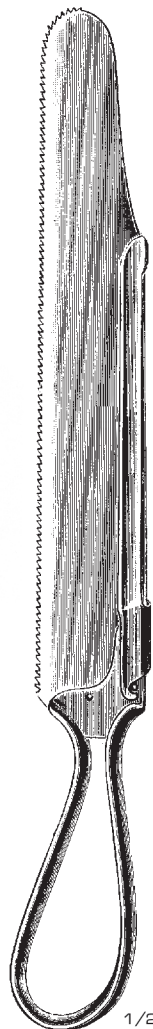

Charriere
02-035-125 12.5 cm / 5"
02-036-18 18 cm / 7"
02-037-21 21 cm / 8 1/4"
02-038-24 24 cm / 9 1/2"
02-039-27 27 cm / 10 1/2"
02-040-30 30 cm / 12"

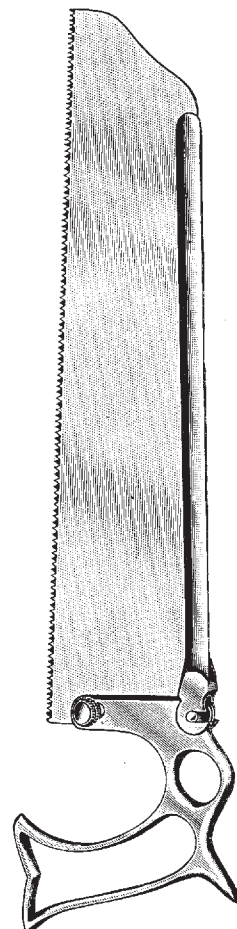

Weiss Blade size
02-041-20 20 cm / 8"
02-042-23 23 cm / 9"
02-043-25 25 cm / 10"
02-044-30 30 cm / 12"

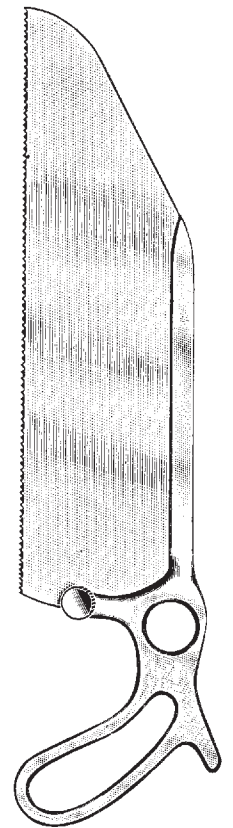

Setterlee Blade size
02-045-20 20 cm / 8"
02-046-22 22 cm / 8 3/4"
02-047-25 25 cm / 10"
02-048-30 30 cm / 12"

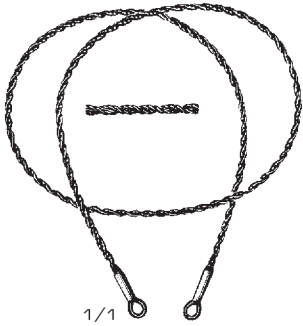

1/1

Gigli
02-049-30 30 cm / 12"
02-050-40 40 cm / 15³/₄"
02-051-50 50 cm / 19³/₄"

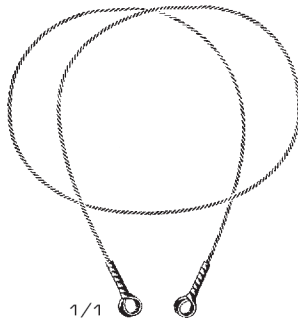

1/1

Gigli
02-052-30 30 cm / 12"
02-053-40 40 cm / 15³/₄"
02-054-50 50 cm / 19³/₄"

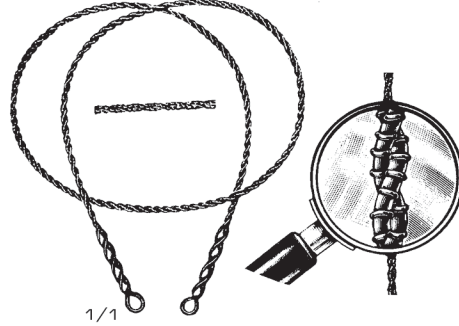

1/1

Olivecrona
02-055-30 30 cm / 12"
02-056-40 40 cm / 15³/₄"
02-057-50 50 cm / 19³/₄"

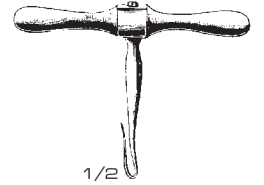

1/2

02-026-05
5 cm / 2"
Hook handle
for wire saws



1/3

Lindemann
02-058-20
20 cm / 8"



1/2

Bruns
02-059-21
21 cm / 8¹/₄"

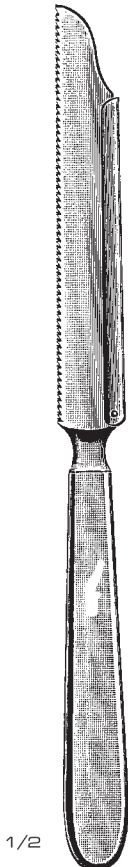

1/2

Langenbeck
02-060-23
23 cm / 9"

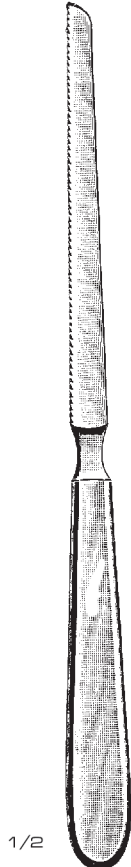

1/2

Langenbeck
02-061-23
23 cm / 9"



1/4

Charrierre
02-062-33 33 cm / 13¹/₄"
02-063-35 35 cm / 14"
02-064-45 45 cm / 18"
With 2 blades
Blades width 12, 15 mm



1/3

Collin
02-065-33
33 cm / 13¹/₄"
With 3 blades
Blades width 6, 8, 12 mm
02-066-35
35 cm / 14"
With 4 blades
Blades width 4, 5, 8, 12 mm

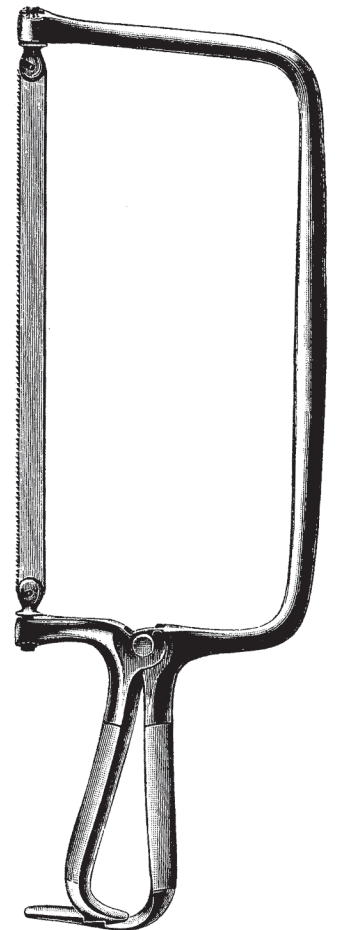

BONE HOLDING FORCEPS

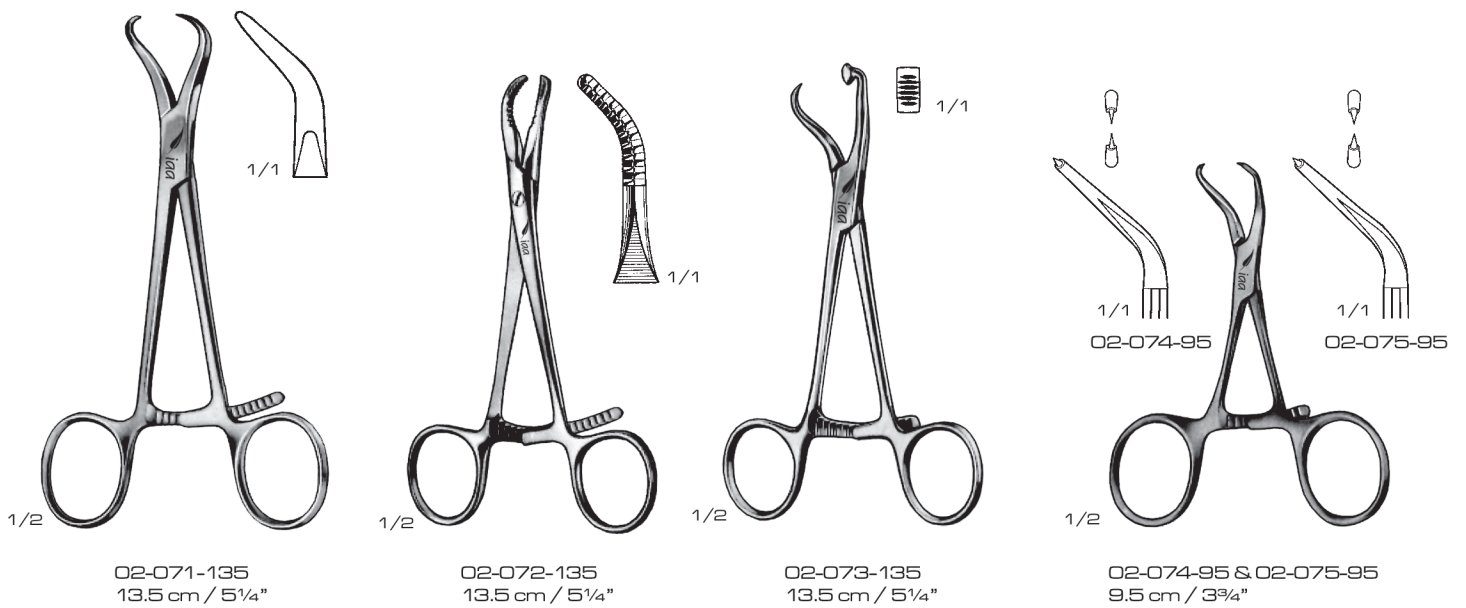
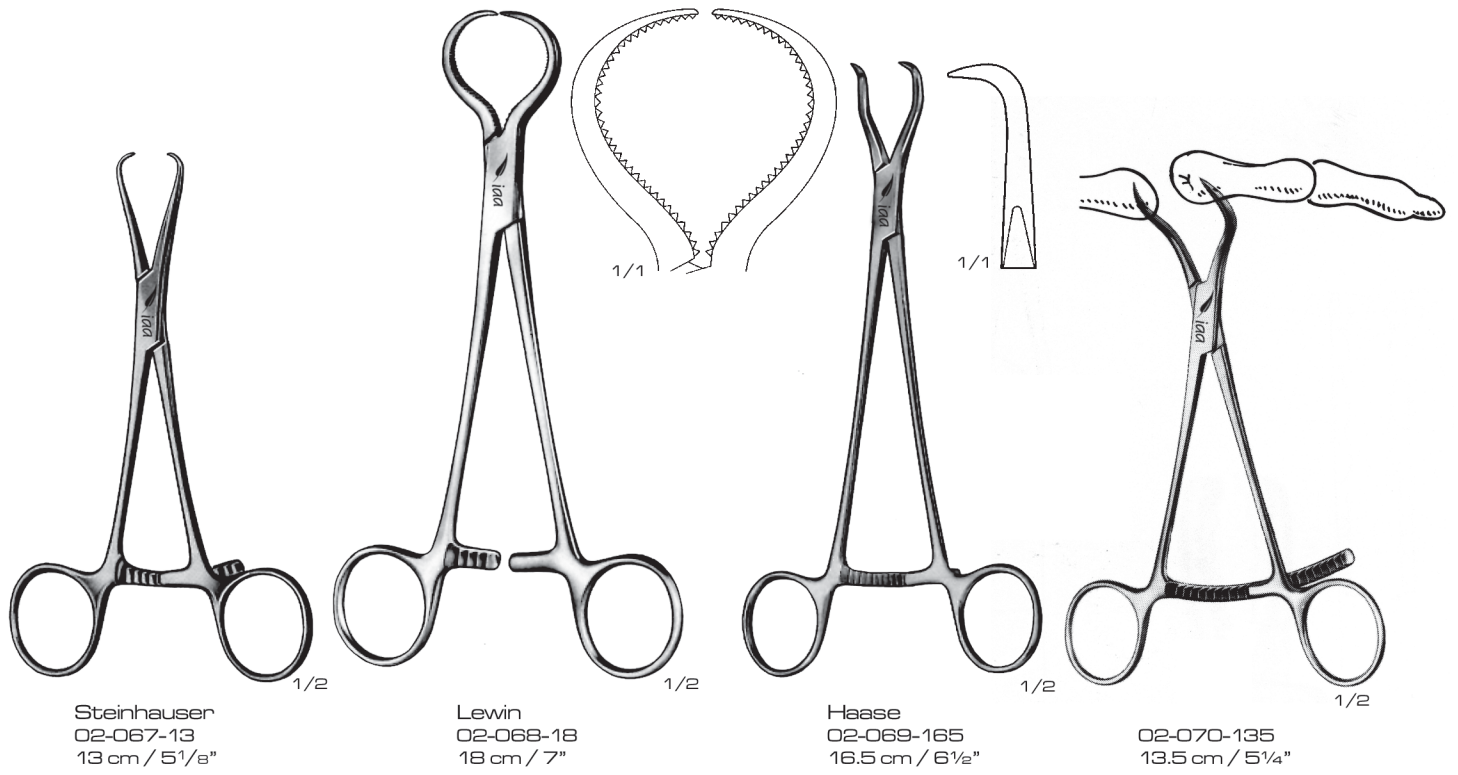



02-076-21
21 cm / 8¼"

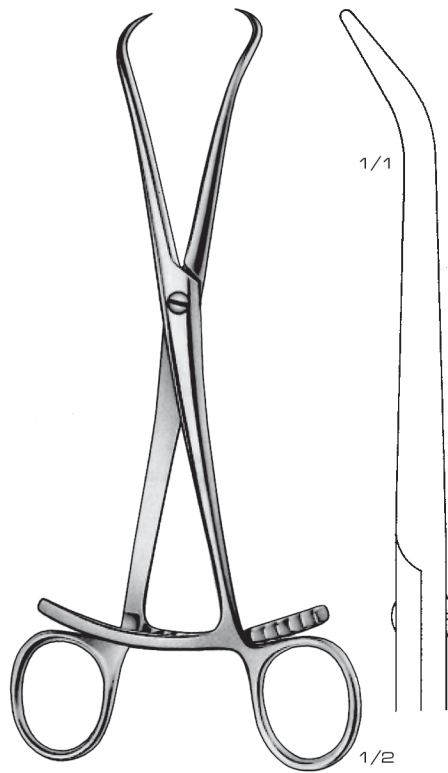

02-077-20
20 cm / 8"

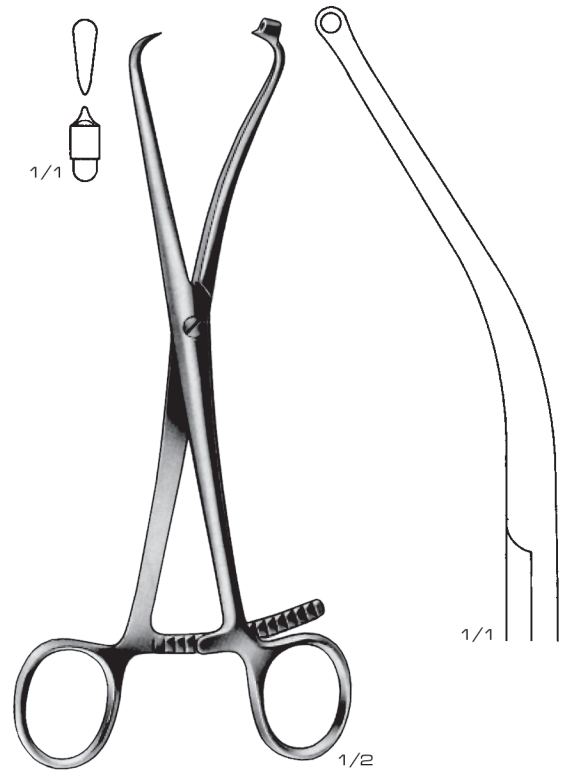

Meyer
02-078-20
20 cm / 8"

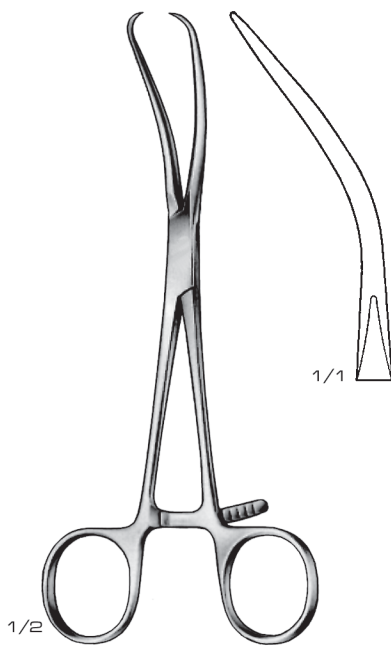

Reill
02-079-17
17 cm / 6¾"

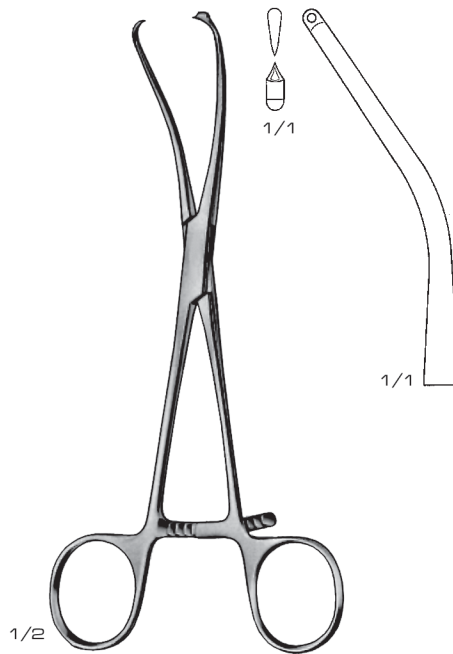

Meyer
02-080-17
17 cm / 6¾"



02-081-14
14 cm / 5½"

BONE HOLDING FORCEPS

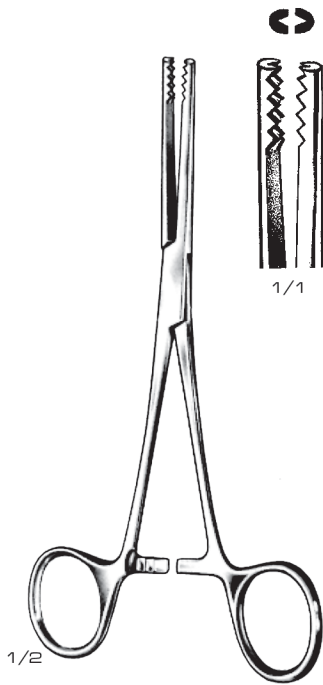

02-082-16
16 cm / 6¼"

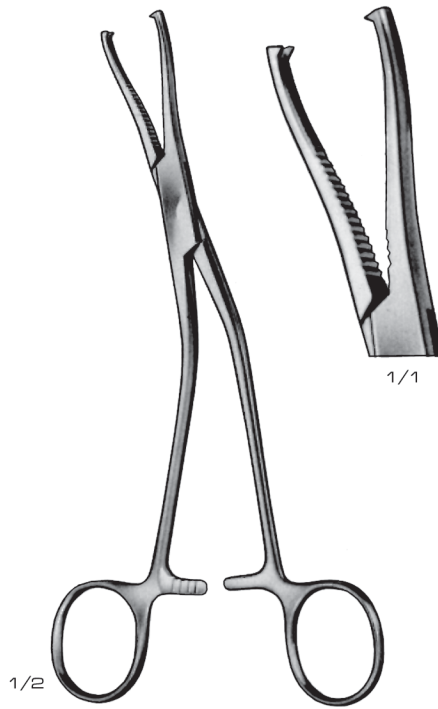

Dingmann
02-083-185
18.5 cm / 7¼"

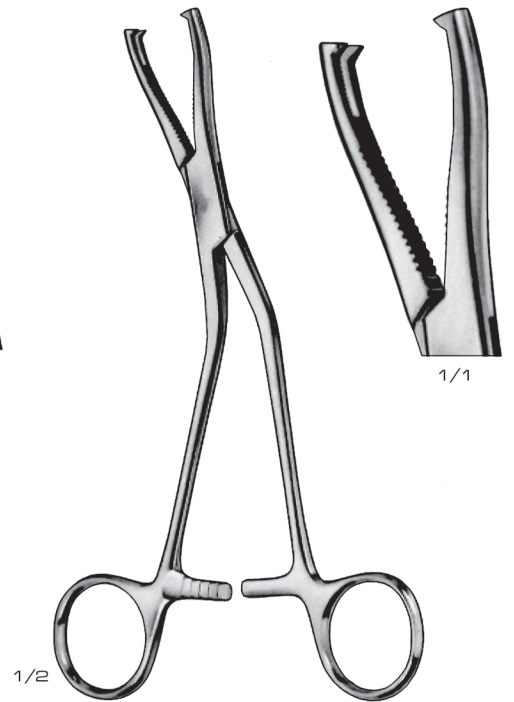

Dingmann
02-084-185
18.5 cm / 7¼"

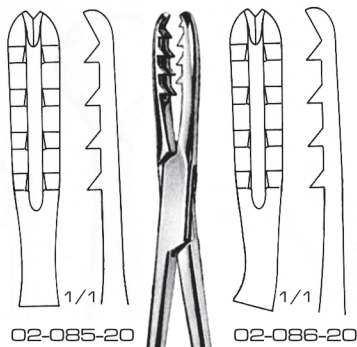

02-085-20

02-086-20



Perman
02-087-21
21 cm / 8¼"



02-088-19
19 cm / 7½"

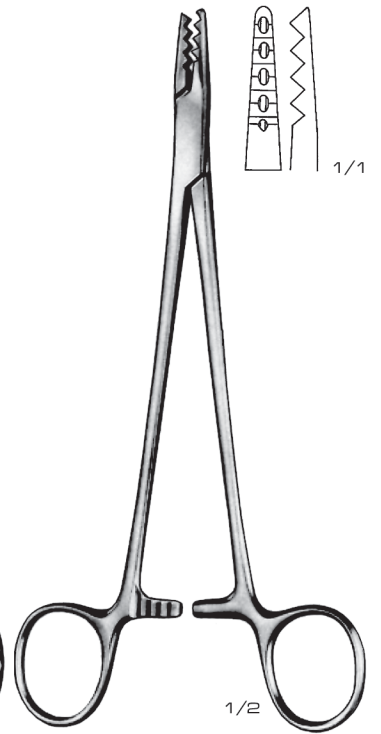

02-089-19
19 cm / 7½"



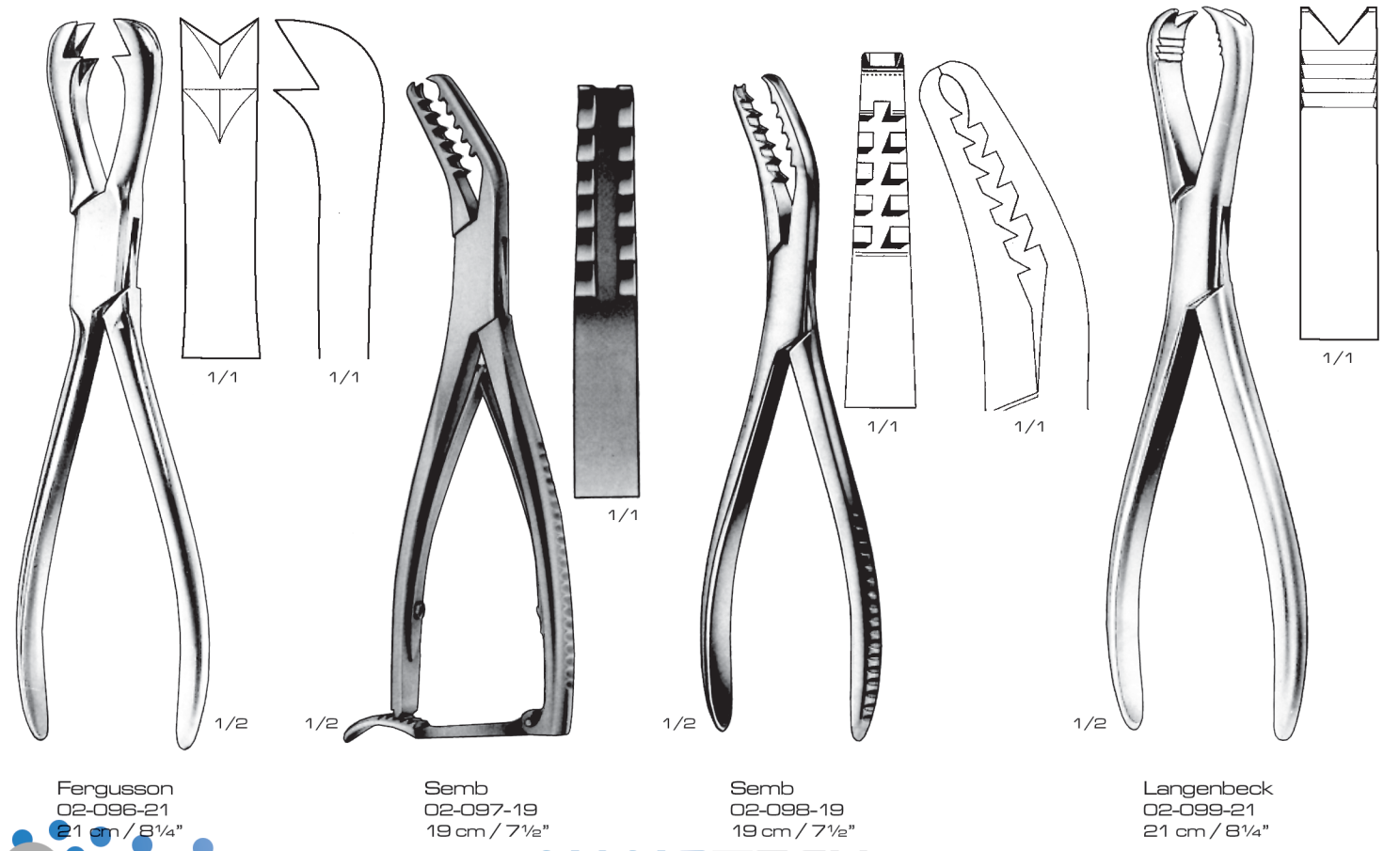
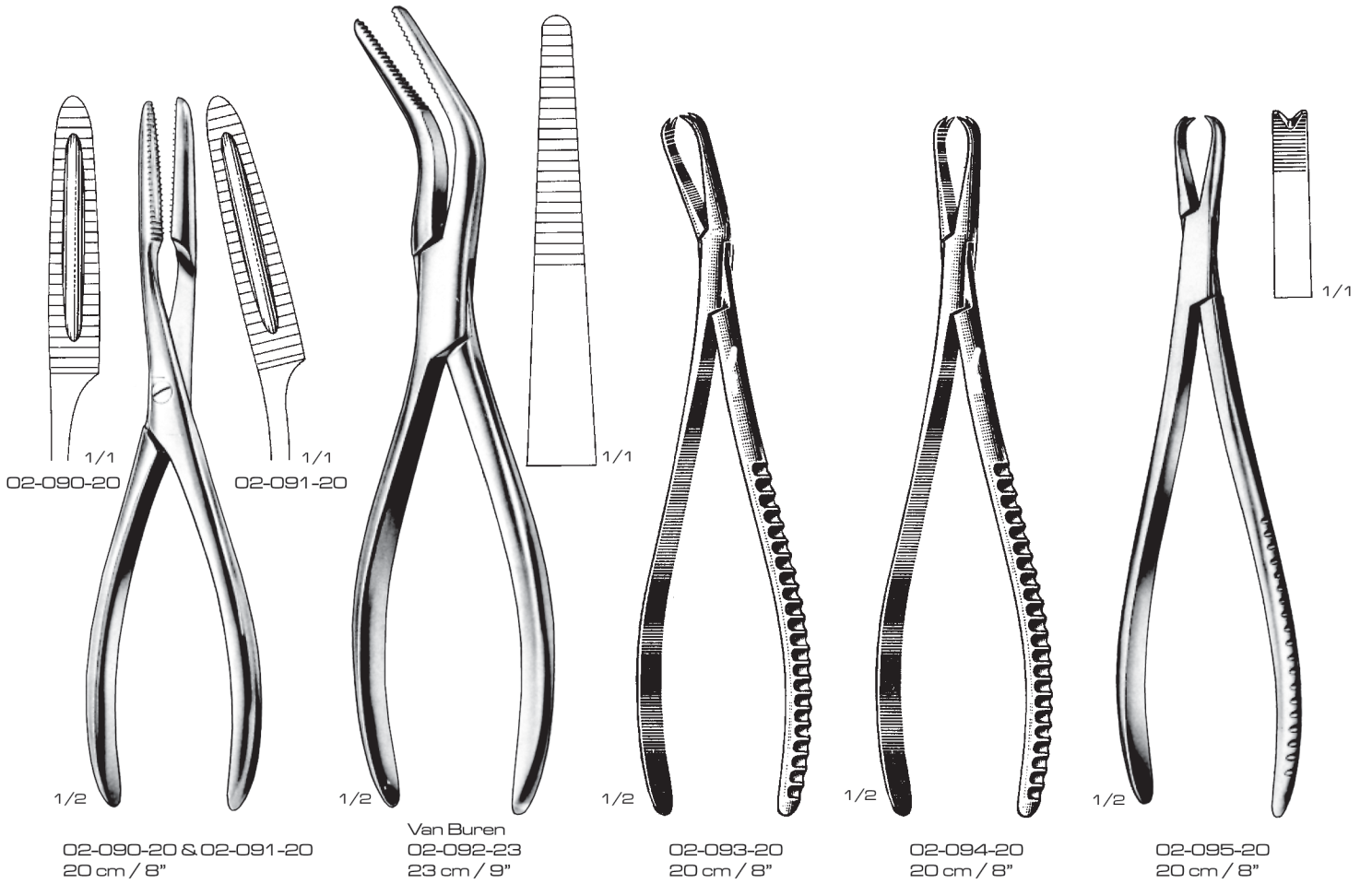

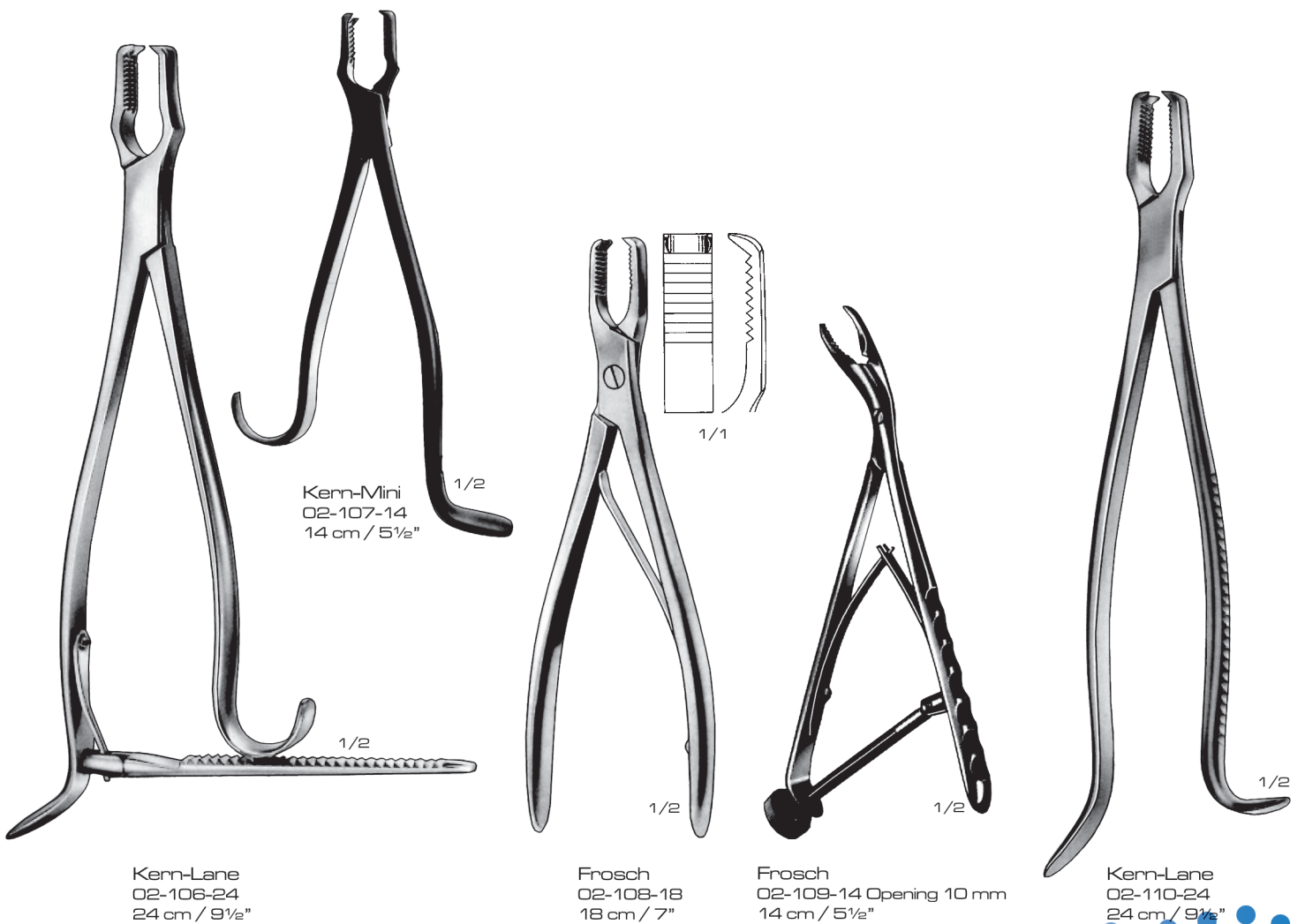
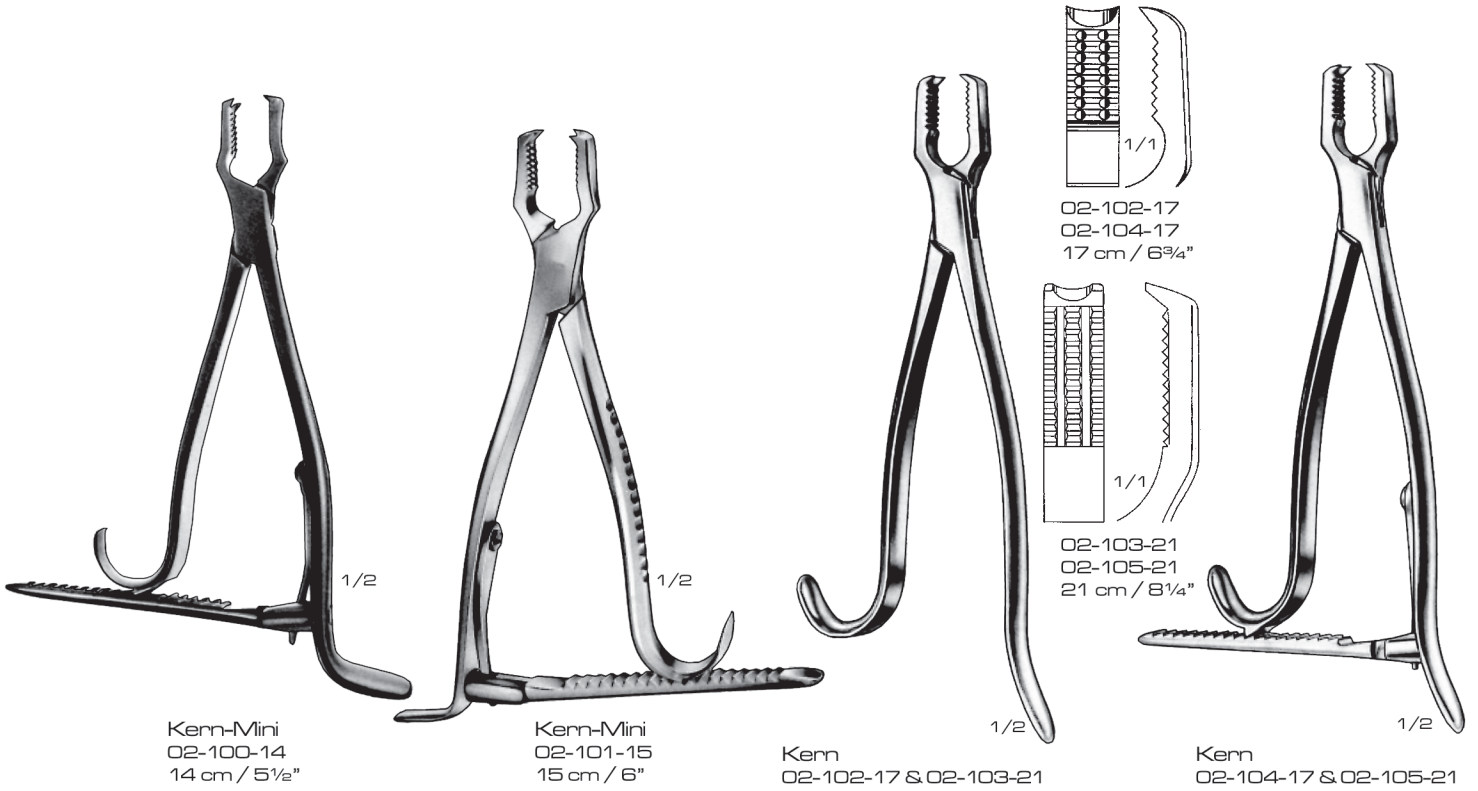



Farabeuf-Lambotte
02-111-15
15 cm / 6"

1/2

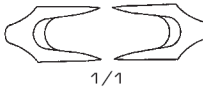
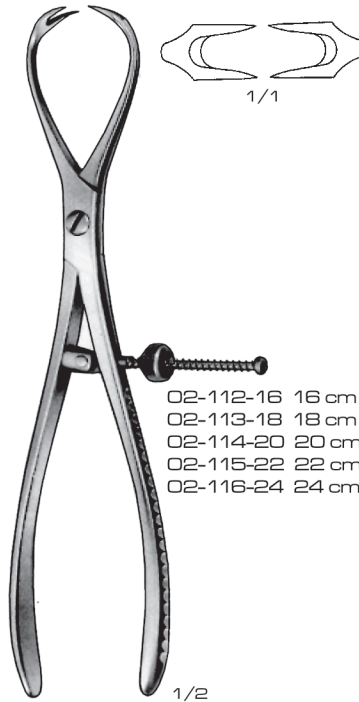

1/1

02-112-16 16 cm / 6 1/4"
02-113-18 18 cm / 7"
02-114-20 20 cm / 8"
02-115-22 22 cm / 8 3/4"
02-116-24 24 cm / 9 1/2"

1/2



02-117-16 16 cm / 6 1/4"
02-118-18 18 cm / 7"
02-119-20 20 cm / 8"
02-120-22 22 cm / 8 3/4"
02-121-24 24 cm / 9 1/2"

1/2

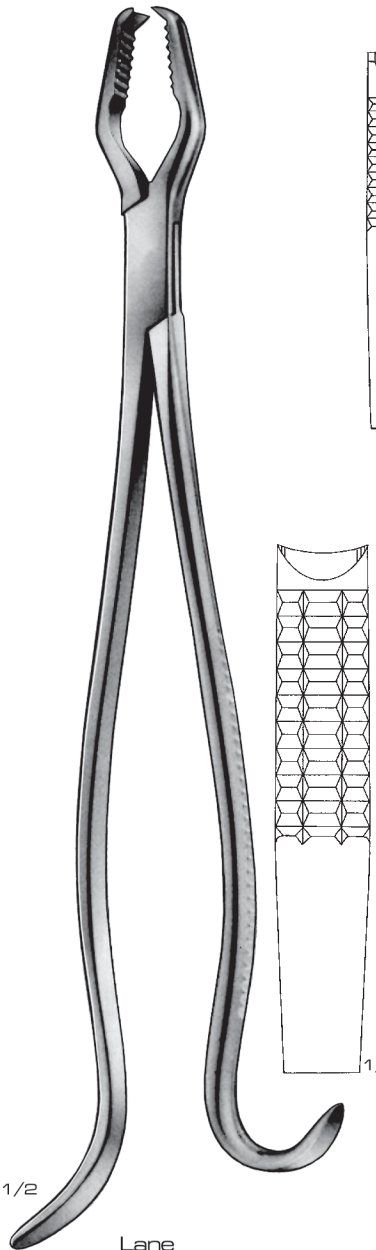

1/2

Lane
02-122-33 & 02-123-45

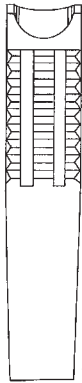

1/1

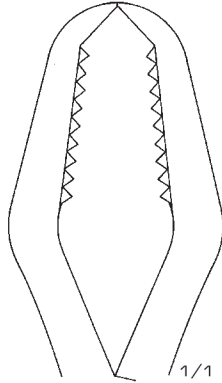

1/1

02-122-33
02-124-33
33 cm / 13"

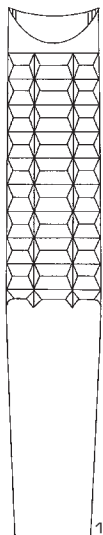

1/1

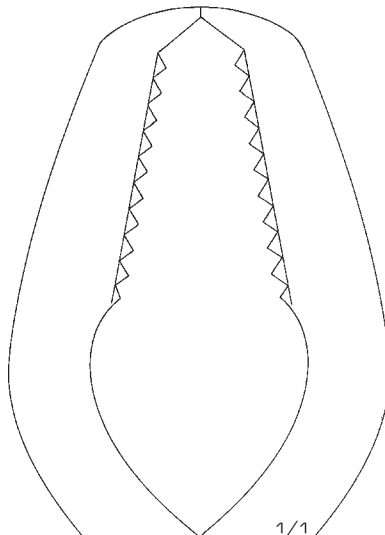

1/1

02-123-45
02-125-45
45 cm / 17 3/4"

1/2



Lane
02-124-33 & 02-125-45

BONE HOLDING FORCEPS

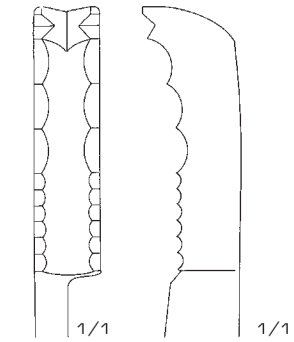

02-126-23 23 cm / 9" 9 mm
02-127-26 26 cm / 10 1/4" 11 mm

Farabeuf
02-126-23 & 02-127-26



1/2
02-128-215
21.5 cm / 8 1/2"

02-128-215 &
02-129-275

1/2
02-129-275
27.5 cm / 10 3/4"

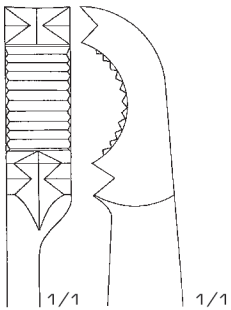
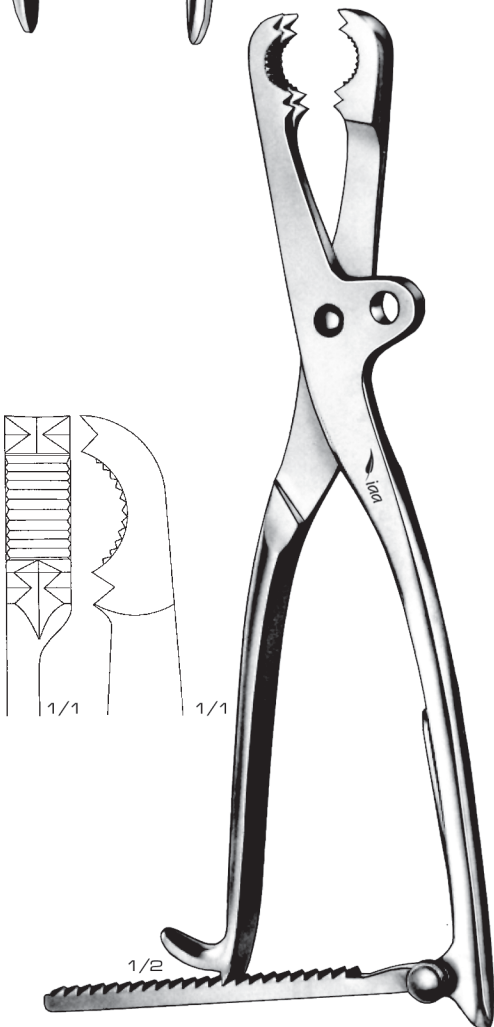

Tuffier
02-130-27
27 cm / 10 1/2"

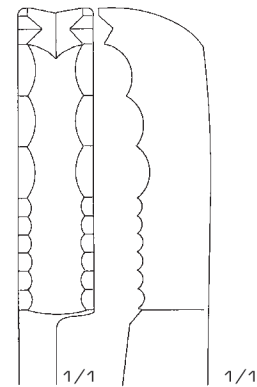
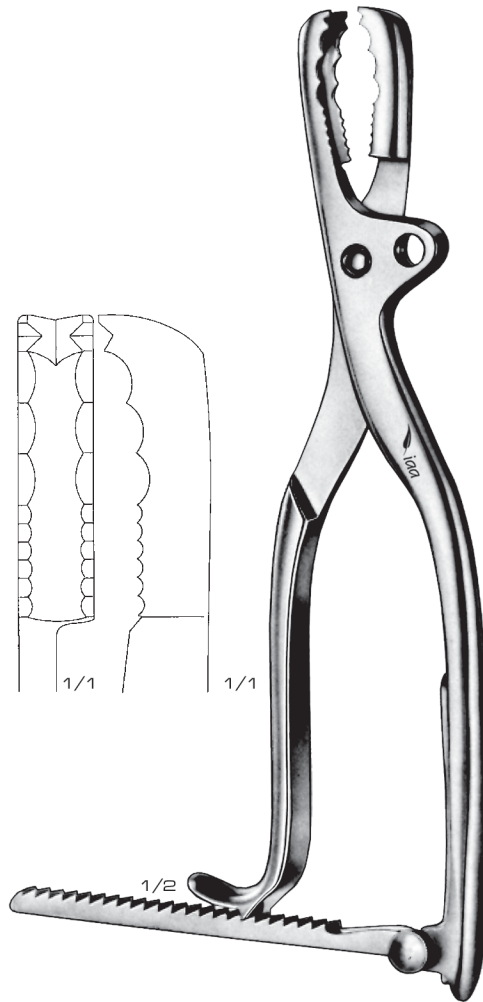

Farabeuf-Lambotte
02-131-26
26 cm / 10 1/4"

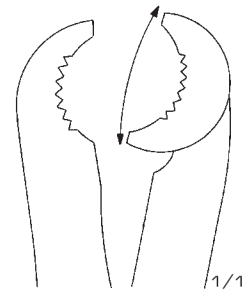
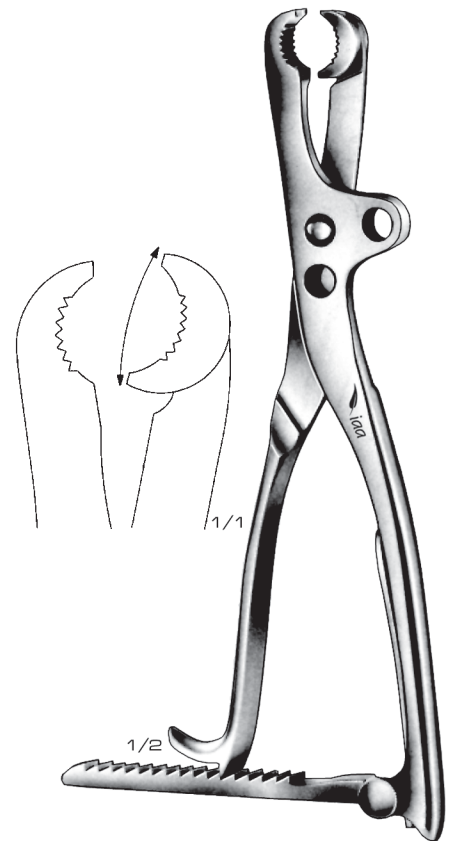

Lambotte
02-132-22 22 cm / 8 3/4"
02-133-27 27 cm / 10 1/2"
02-134-30 30 cm / 12"

02-135-16 16 cm / 6¼"
02-136-18 18 cm / 7"
02-137-20 20 cm / 8"
02-138-22 22 cm / 8¾"
02-139-24 24 cm / 9½"

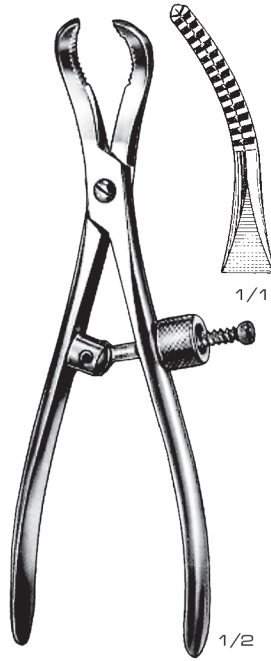

1/2
02-140-22
22 cm / 8¾"



1/2
02-141-26
26 cm / 10¼"



Lambotte
02-140-22 To
02-142-33



1/2
02-142-33
33 cm / 13"

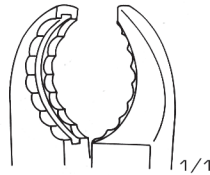
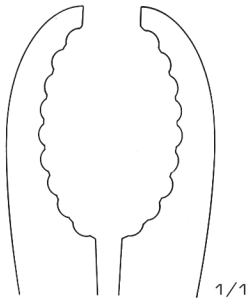

02-143-23
02-146-23
23 / cm 9"

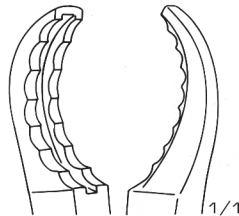

02-144-25
02-147-25
25 / cm 10"

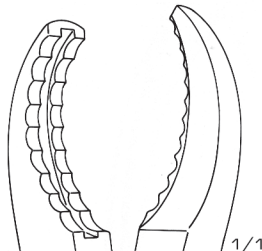

02-145-28
02-148-28
28 / cm 11"

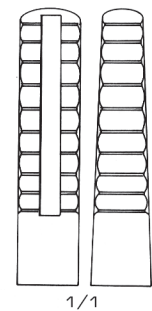
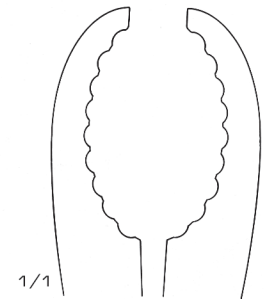

Ulrich
02-143-23 To 02-145-28

Ulrich
02-146-23 To 02-148-28

BONE HOLDING FORCEPS

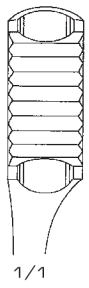

1/1



1/2

Verbrugge
02-149-25 To 02-151-27

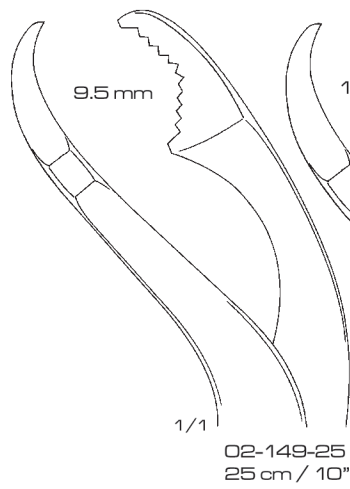

9.5 mm

1/1

02-149-25
25 cm / 10"

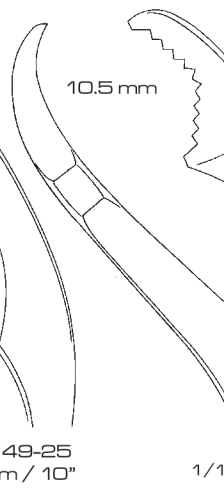

10.5 mm

1/1

02-150-26
26 cm / 10 1/4"

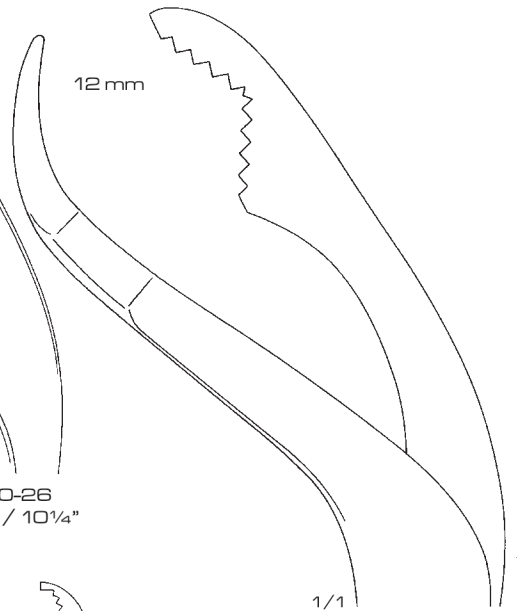

12 mm

1/1

02-151-27
27 cm / 11"

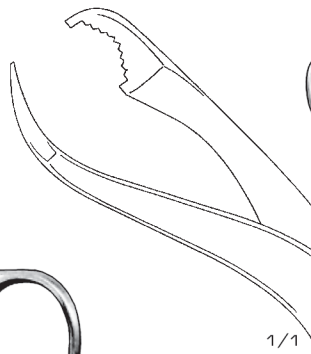

5 mm

1/1

1/1

Verbrugge
02-152-17
17 cm / 6 3/4"

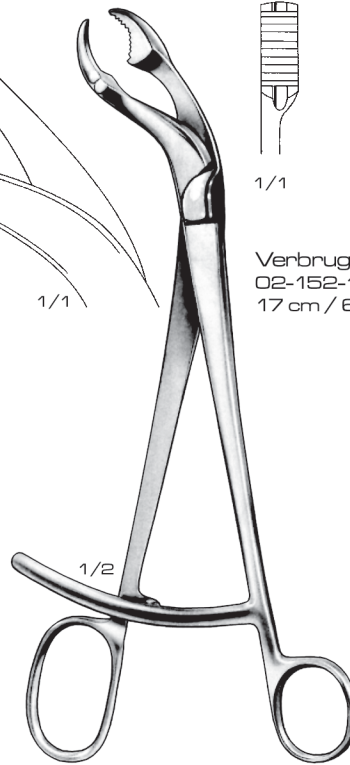

1/2

02-153-15 To
02-157-28
Self-Centering

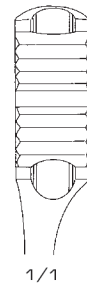

1/1

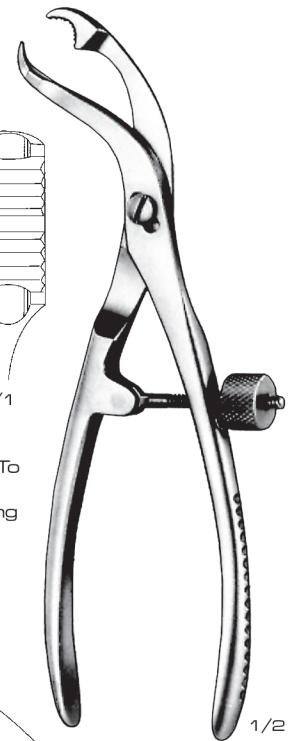

1/2

2.5 mm



1/1

02-153-15
15 cm / 6"

6.5 mm



1/1

02-154-19
19 cm / 7 1/2"

9.5 mm



1/1

02-155-24
24 cm / 9 1/2"

10 mm



1/1

02-156-26
26 cm / 10 1/4"

11 mm



1/1

02-157-28
28 cm / 11"



02-162-00 Child size
02-163-00 Adult size



1/2

2/3

02-158-16 16 cm / 6¼"
02-159-19 19 cm / 7½"
02-160-23 23 cm / 9"
02-161-25 25 cm / 10"



2/3



02-164-16 16 cm / 6¼"
02-165-19 19 cm / 7½"
02-166-23 23 cm / 9"
02-167-25 25 cm / 10"

7.5 mm



02-169-27
27 cm / 10½"

6.5 mm



02-168-21
21 cm / 8¼"

8.5 mm



02-170-30
30 cm / 12"

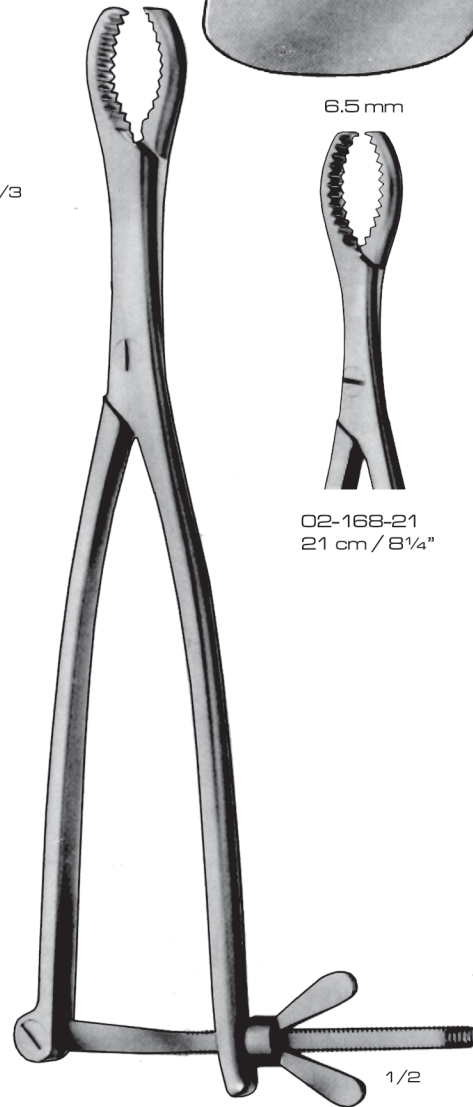

1/2

Hey-Groves
02-168-21 To 02-170-30
Both blades serrated

BONE HOLDING FORCEPS AND PERCY RETRACTORS

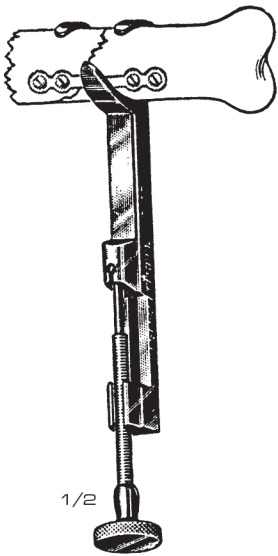

1/2

Lowmann
02-171-12 12 cm / 4 3/4"
02-172-15 15 cm / 6"



1/2

Lowmann
02-173-12 12 cm / 4 3/4"
02-174-15 15 cm / 6"
02-175-18 18 cm / 7"
02-176-20 20 cm / 8"
02-177-22 22 cm / 8 3/4"



1/2

Lowmann-Hoglund
02-178-12 12 cm / 4 3/4"
02-179-15 15 cm / 6"
02-180-18 18 cm / 7"
02-181-20 20 cm / 8"
02-182-22 22 cm / 8 3/4"

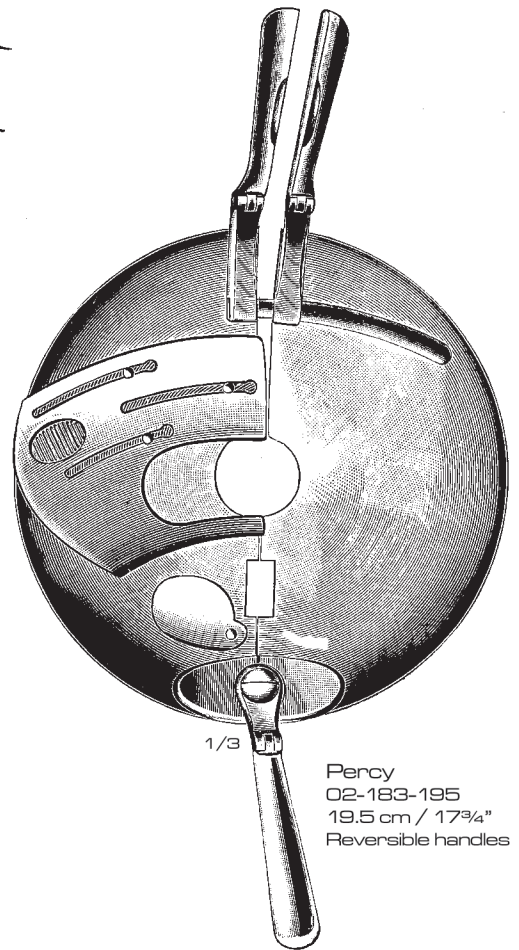

1/3

Percy
02-183-195
19.5 cm / 7 3/4"
Reversible handles

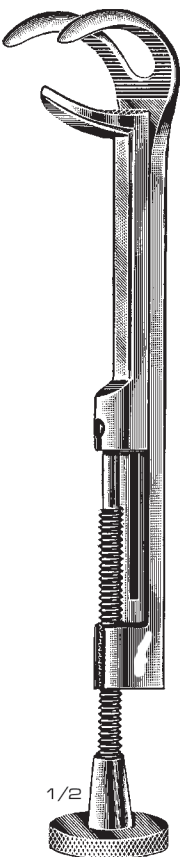

1/2

Lowmann
02-184-18 To 02-186-22

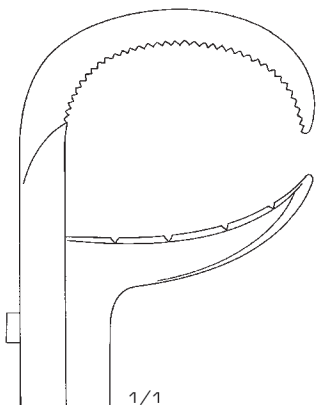

1/1

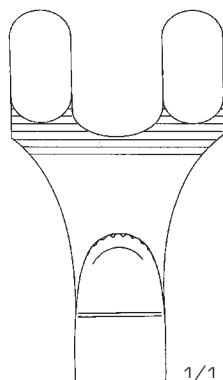

1/1

02-184-18
18 cm / 7"

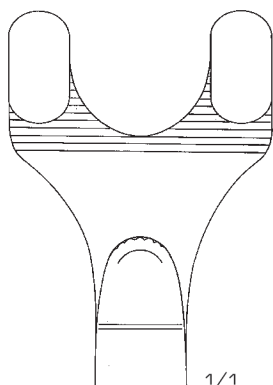

1/1

02-185-20
20 cm / 8"

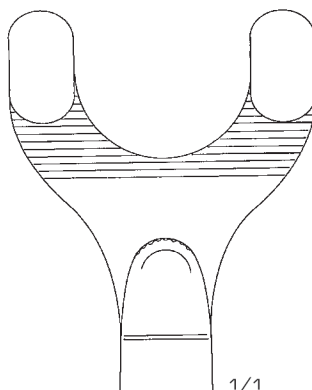

1/1

02-186-22
22 cm / 8 3/4"

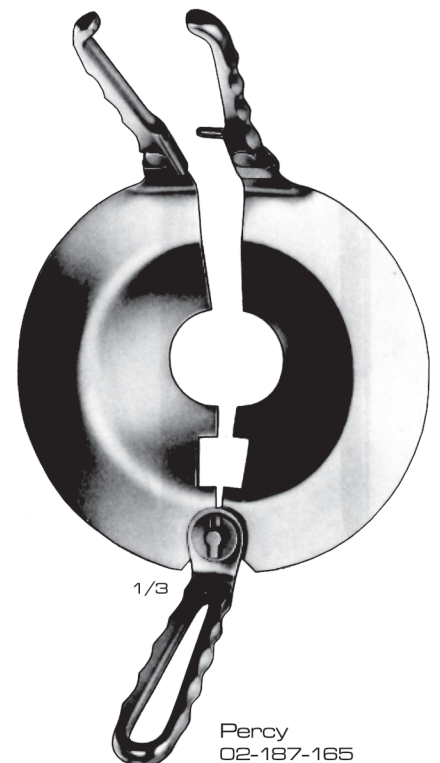

1/3

Percy
02-187-185
16.5 cm / 6 1/2"



Walton
02-188-17
17 cm / 6¾"



02-189-17
17 cm / 6¾"



02-190-145
14.5 cm / 5¾"



1/1



1/1

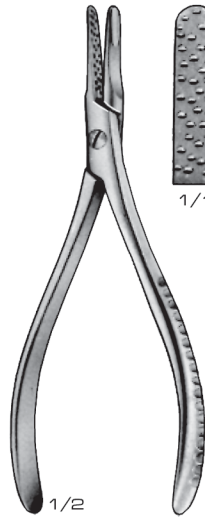

02-191-135
13.5 cm / 5¼"



1/1



1/1

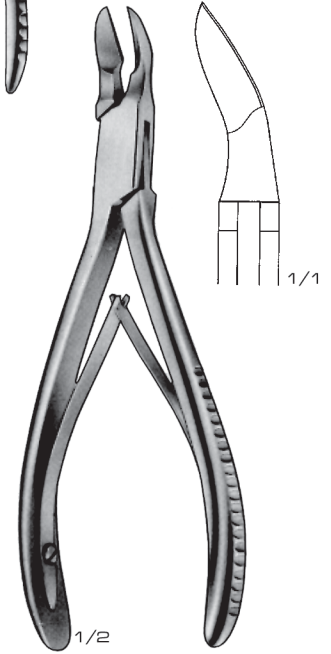

02-192-17
17 cm / 6¾"



Cleveland
02-193-16
16 cm / 6¼"

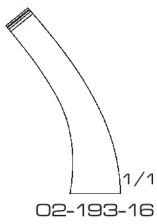

02-193-16
1/1

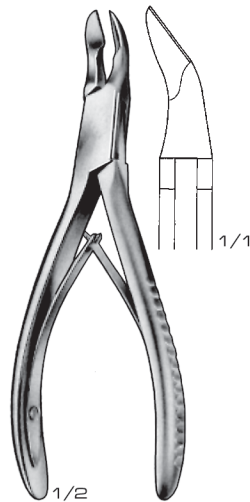

02-194-13
13 cm / 5⅛"

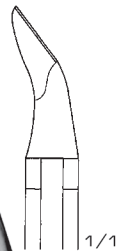

1/1

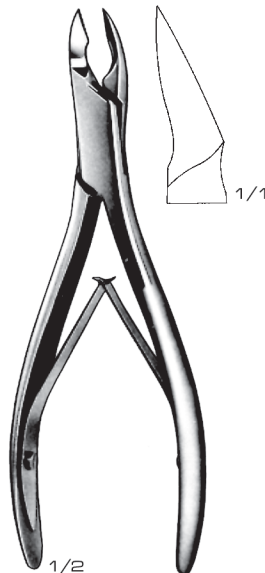

Cleveland
02-195-17
17 cm / 6¾"



1/1



02-196-12
12 cm / 4¾"



1/1

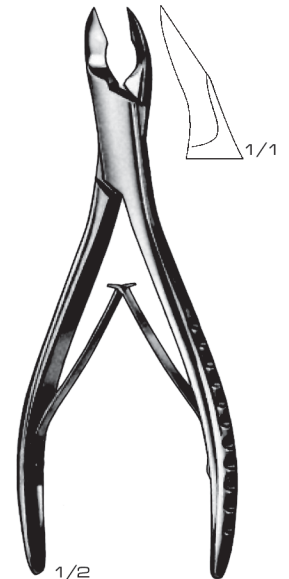

Cleveland
02-197-15
15 cm / 6"



1/1

BONE CUTTING FORCEPS

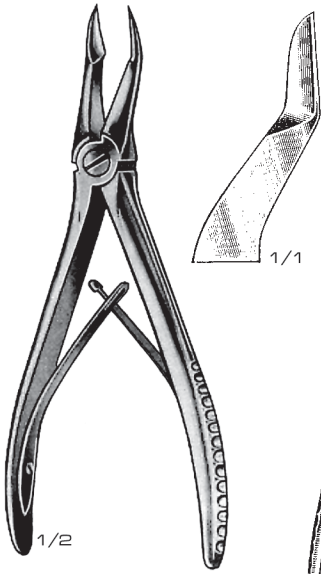

02-198-14
14 cm / 5½"

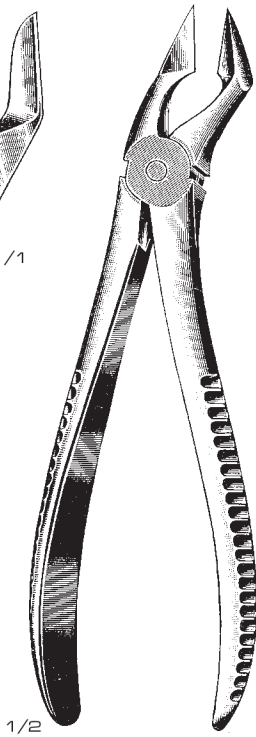

Horsley
02-199-195
19.5 cm / 7¾"

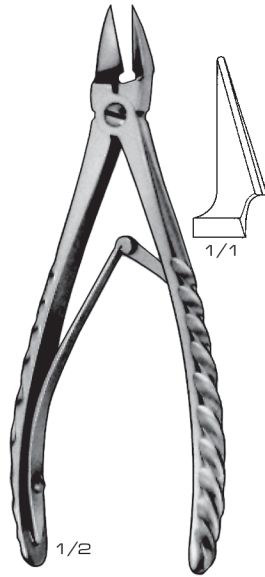

Stamm
02-200-15
15 cm / 6"



Markwalder
02-201-20
20 cm / 8"

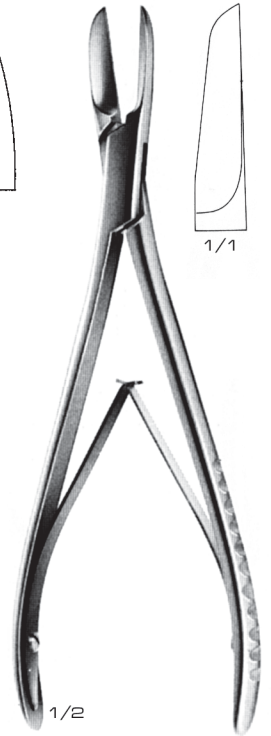

Kazanjian
02-202-185
18.5 cm / 7¼"

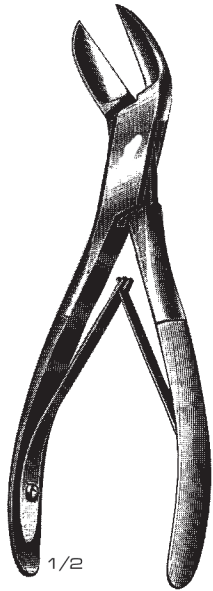

Liston
02-203-14 14 cm / 5½"
02-204-17 17 cm / 6¾"
02-205-20 20 cm / 8"
02-206-22 22 cm / 8¾"

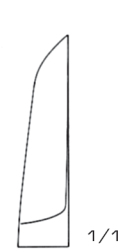

02-211-14
14 cm / 5½"



02-212-17
17 cm / 6¾"



02-207-14
14 cm / 5½"



02-208-17
17 cm / 6¾"



Liston
02-211-14 To 02-214-22

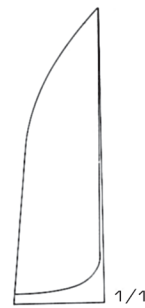

02-213-20
20 cm / 8"

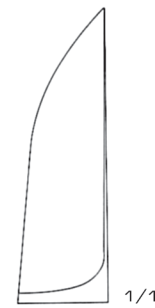

02-214-22
22 cm / 8¾"



Liston
02-207-14 To 02-210-22



02-209-19
19 cm / 7½"



02-210-22
22 cm / 8¾"

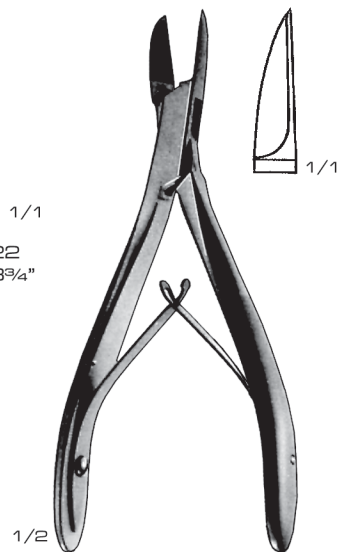

Littauer-Liston
02-215-15
15 cm / 6"

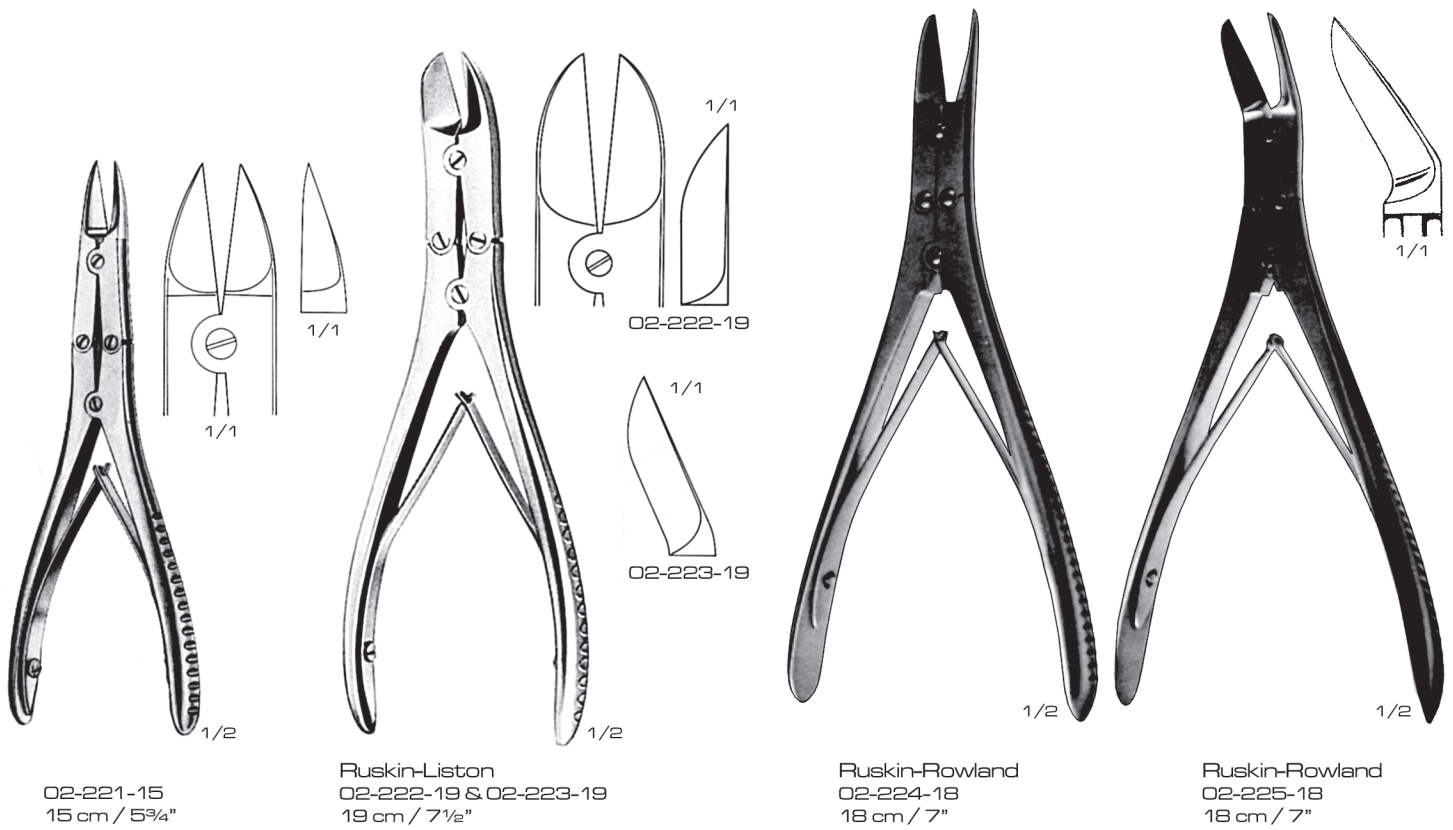
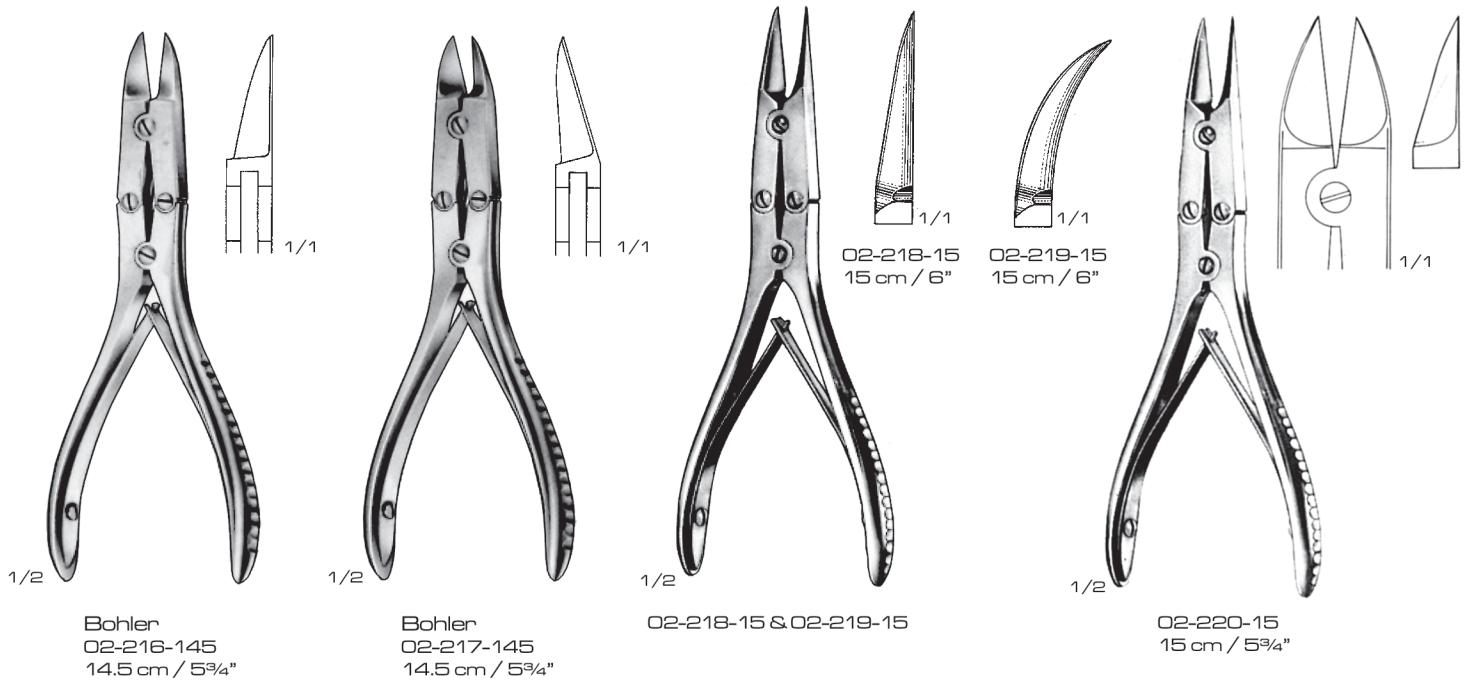

BONE CUTTING FORCEPS

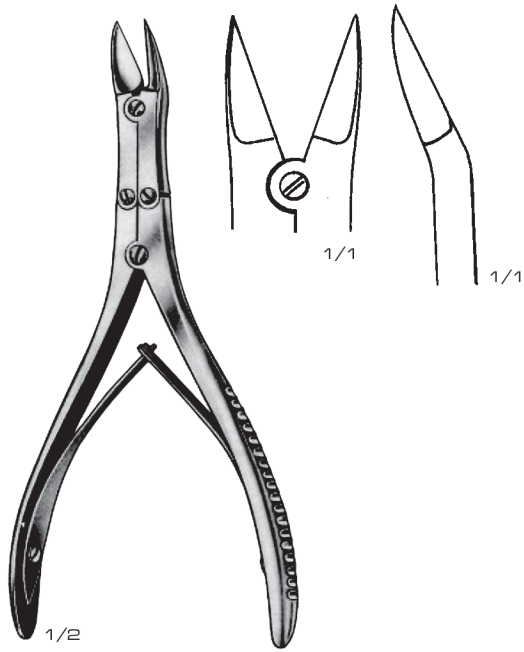

McIndoe
02-226-18
18 cm / 7"

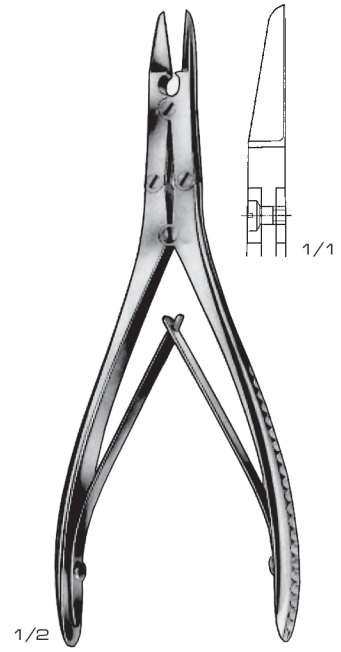

02-227-17
17 cm / 6³/₄"

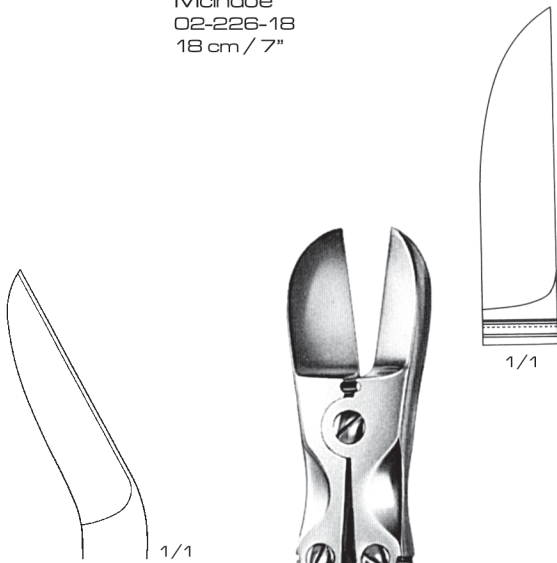

02-228-23 23 cm / 9" Str
02-229-23 23 cm / 9" Cur

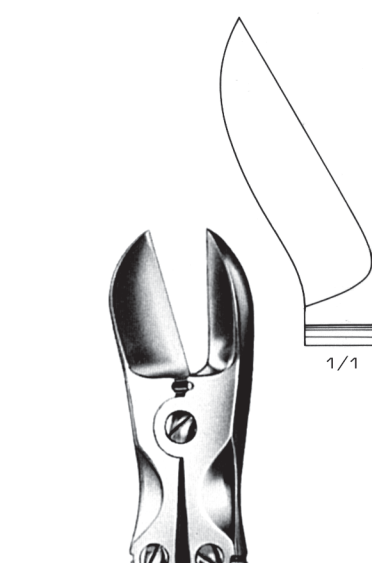

02-230-27 27 cm / 10¹/₂"



02-231-27 27 cm / 10¹/₂"

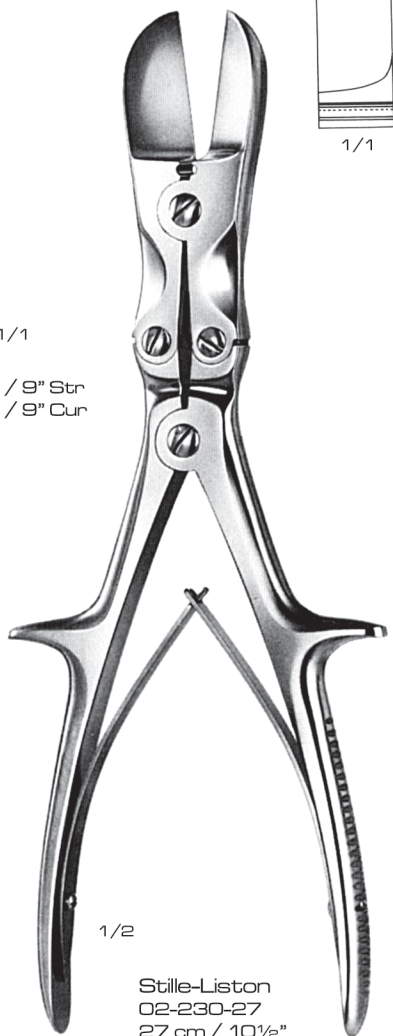

Stille-Liston
02-230-27
27 cm / 10¹/₂"



Stille-Liston
02-231-27
27 cm / 10¹/₂"



Liston-Still
02-232-27
27 cm / 10¹/₂"

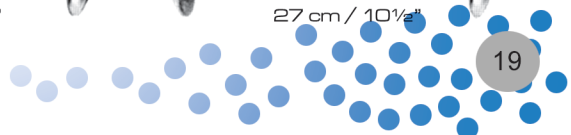



Liston-Key-Horsley
02-233-23 23 cm / 9"
02-234-25 25 cm / 10"



Semb
02-235-24
24 cm / 9½"

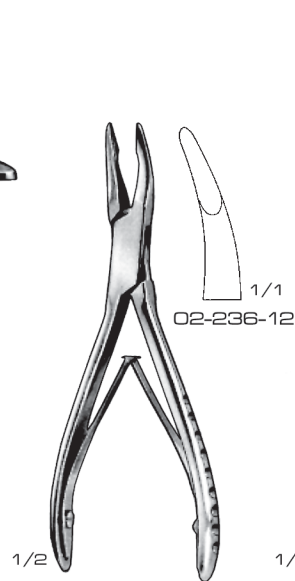

Mini-Freidman
02-236-12
12 cm / 4¾"

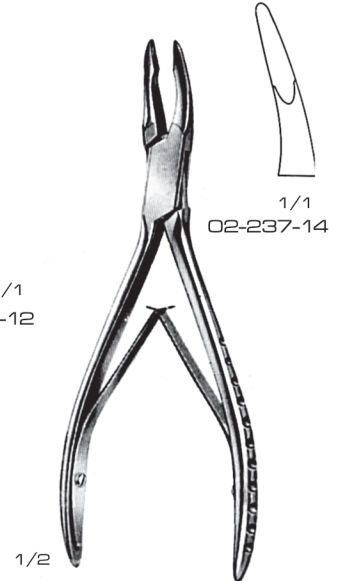

Freidman
02-237-14
14 cm / 4¾"

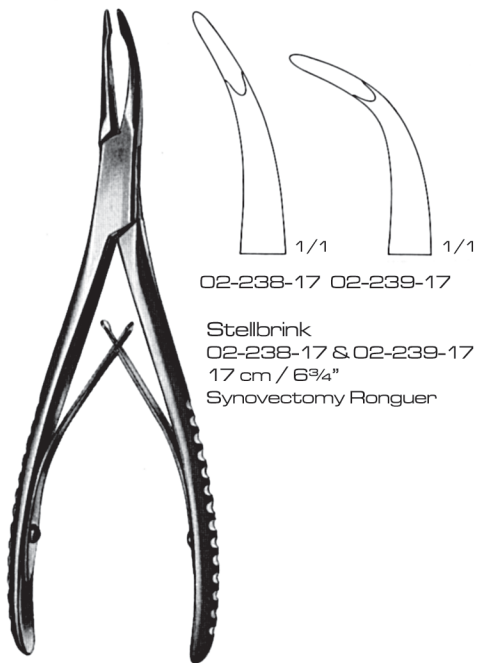

02-238-17 02-239-17
Stellbrink
02-238-17 & 02-239-17
17 cm / 6¾"
Synovectomy Rongeur



Freidman-Vickers
02-240-14
14 cm / 4¾"

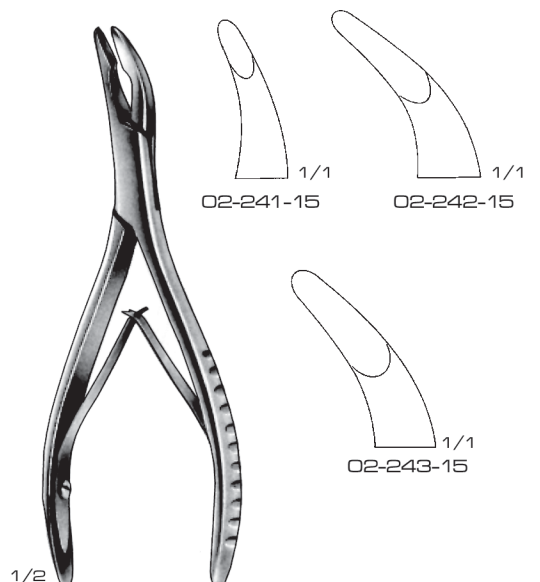

Luer
02-241-15 To 02-243-15
15 cm / 6"



Luer
02-244-18 To 02-247-18
18 cm / 7"

Beyer
02-248-17 & 02-249-17
17 cm / 6¾"

Jansen
02-250-18 & 02-251-18
18 cm / 7"

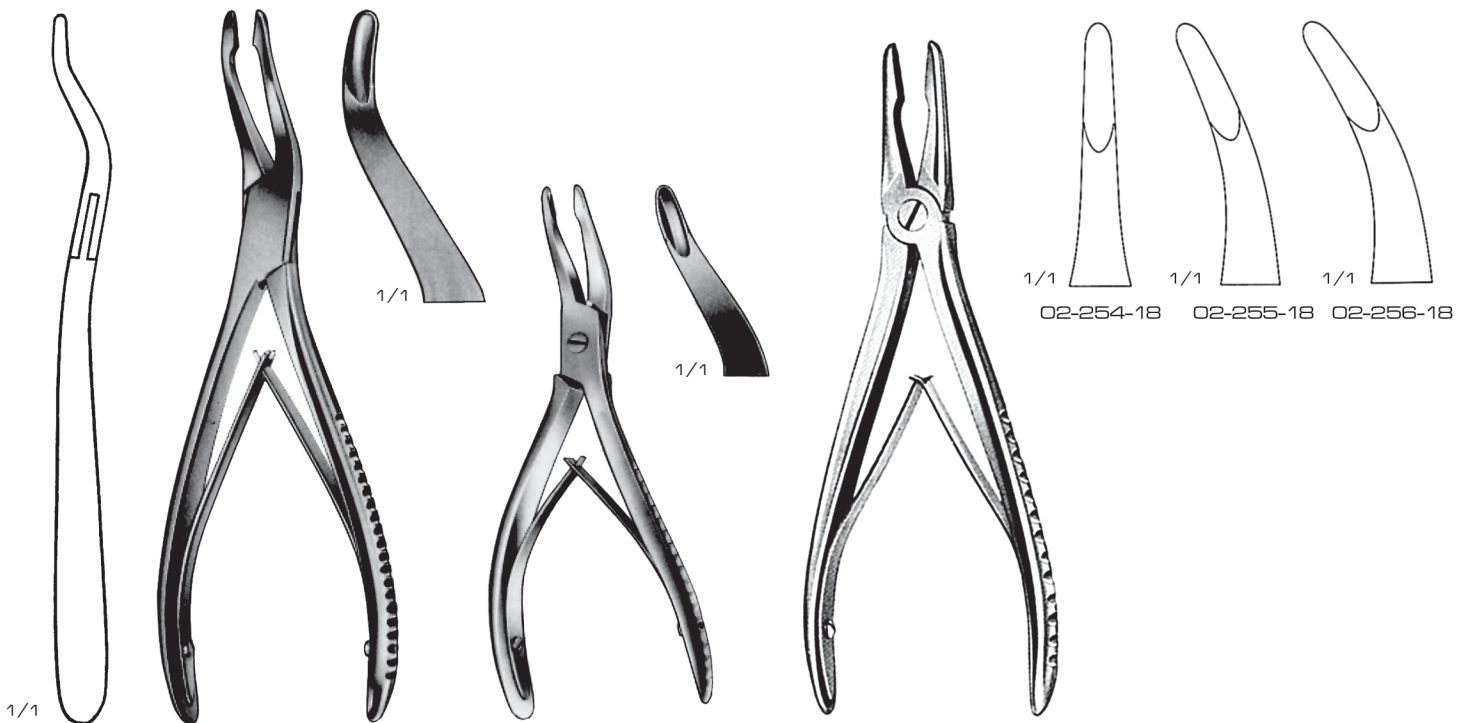

Jansen
02-252-18
18 cm / 7"

Alexander
02-253-14
14 cm / 5½"

Jansen
02-254-18 To 02-256-18
18 cm / 7"

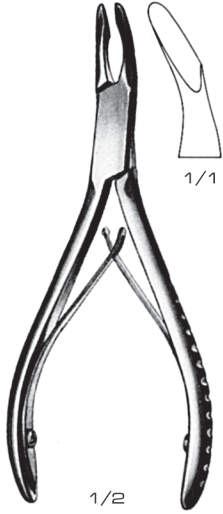

Cleveland
02-257-14
14 cm / 5½"

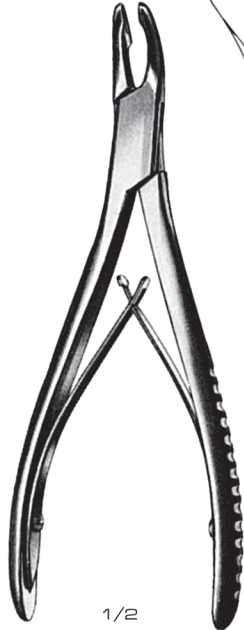

Cleveland
02-258-17
17 cm / 6¾"

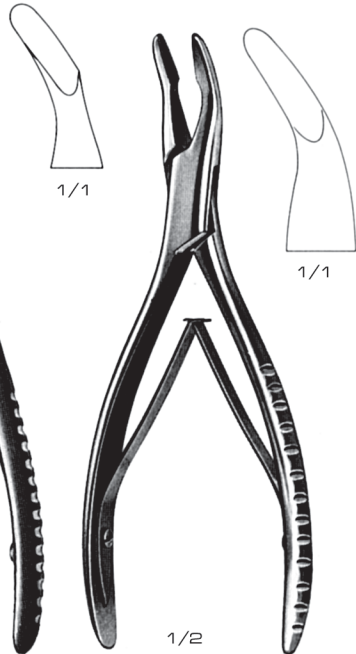

Mead
02-259-165
16.5 cm / 6½"

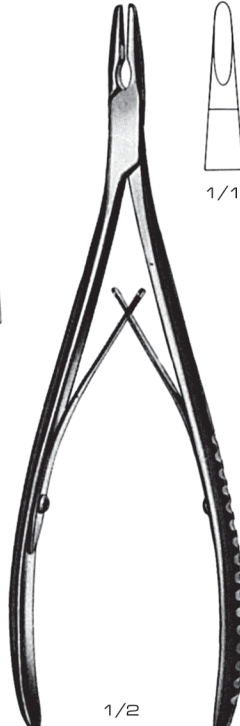

Lampert
02-260-19
19 cm / 7½"

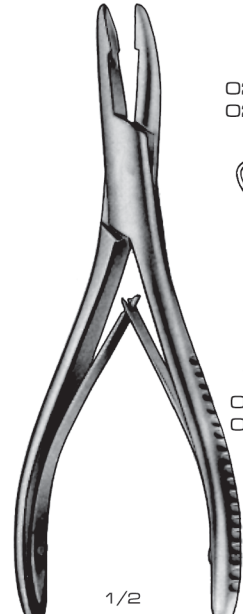

Mead
02-261-14 & 02-262-14
14 cm / 5½"

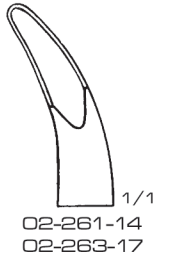

02-261-14
02-263-17



02-262-14
02-264-17

02-263-17 & 02-264-17
17 cm / 6¾"

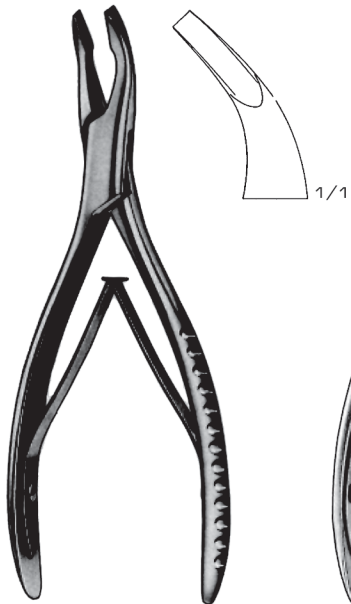

Mead
02-265-165
16.5 cm / 6½"

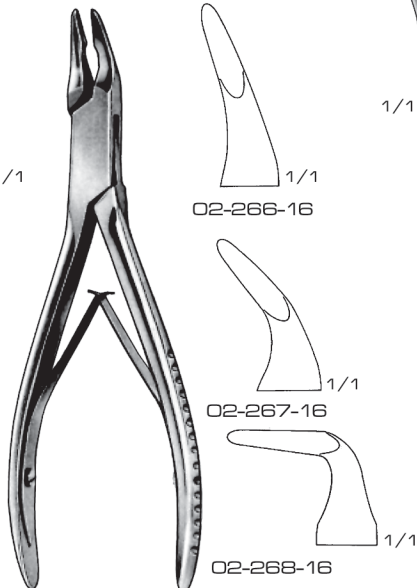

Blumenthal
02-266-16 To 02-268-16
16 cm / 6¼"



1/1



1/1



1/1

02-266-16

02-267-16

02-268-16

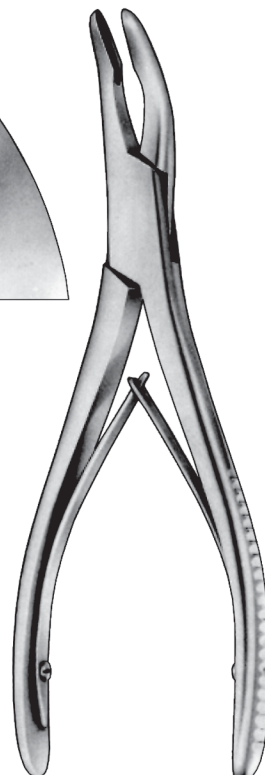

Olivecrona
02-269-20
20 cm / 8"

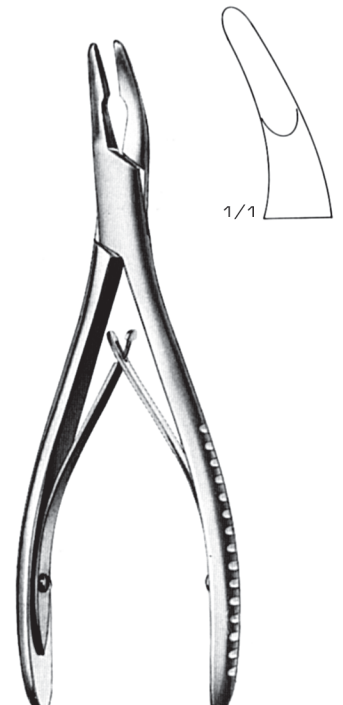

Hartmann
02-270-185
18.5 cm / 7¼"

BONE RONGEURS

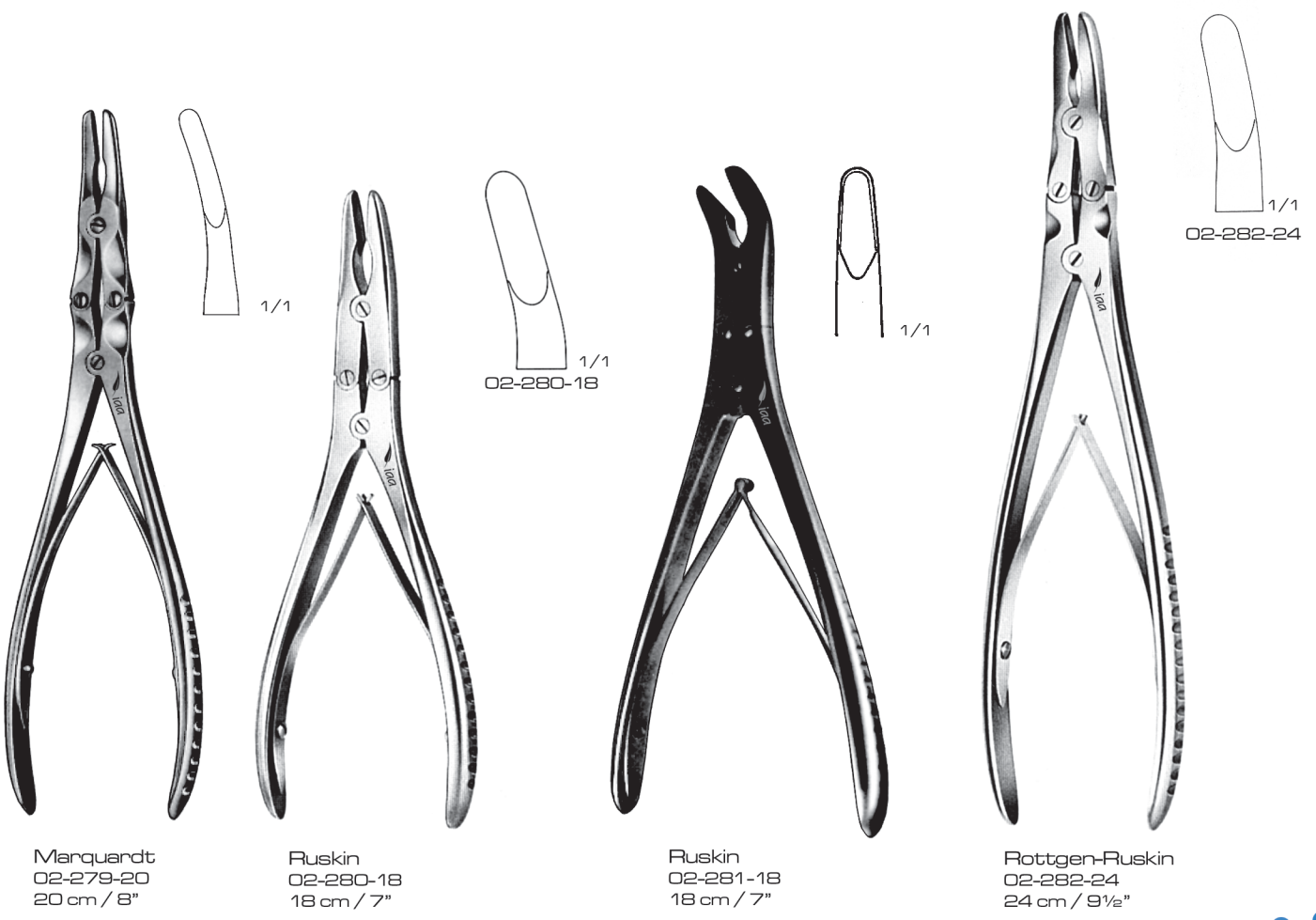
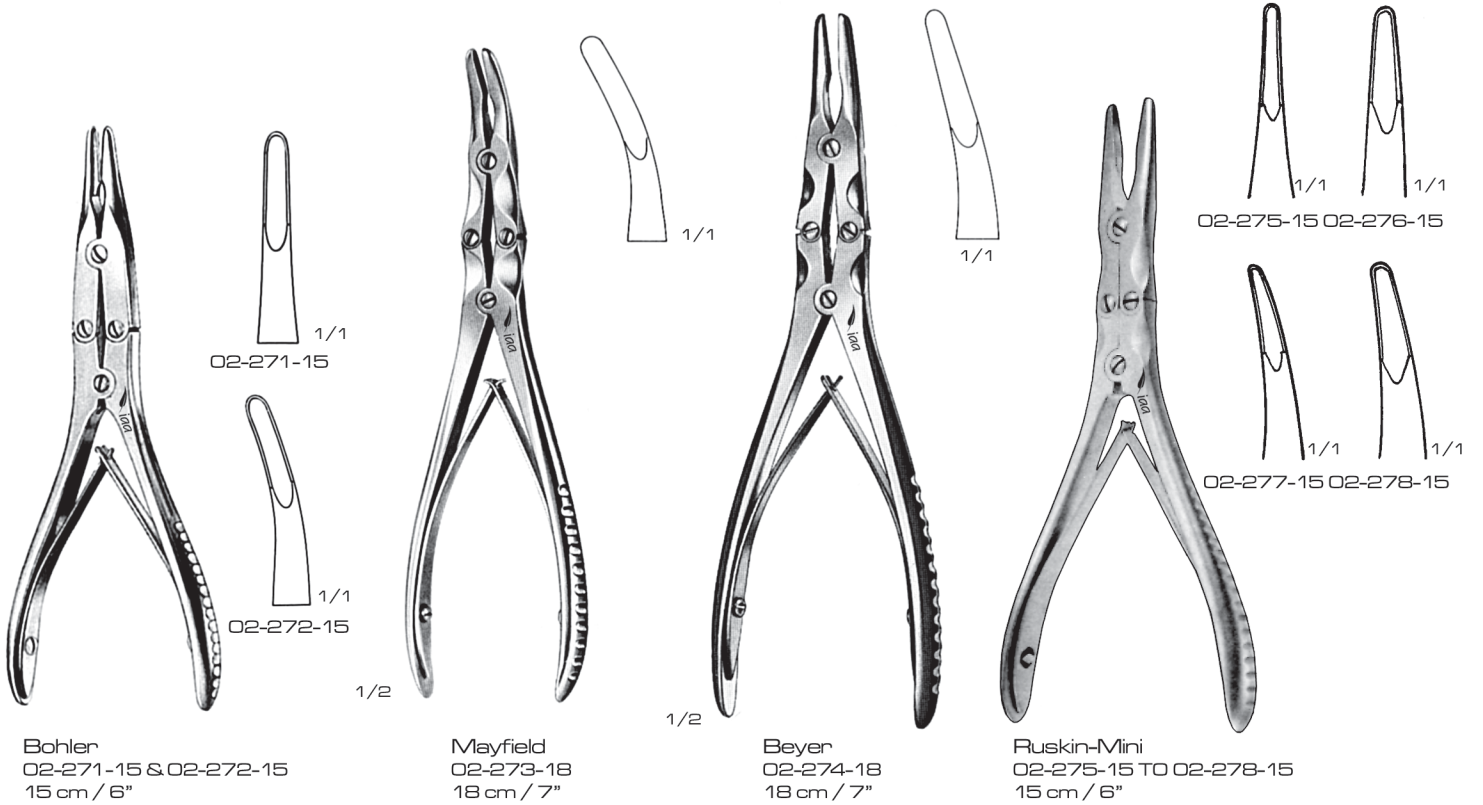



Zaufal-Jansen
02-283-18
18 cm / 7"

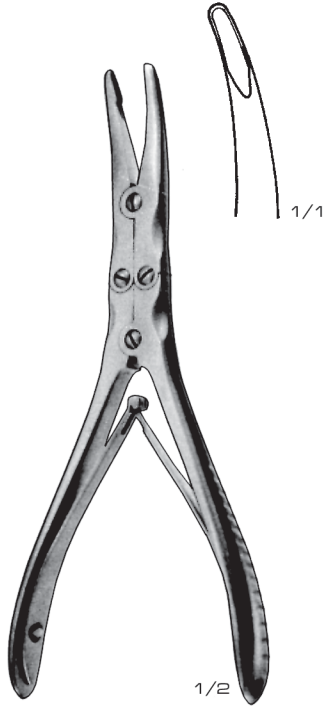

Kleinert-Kutz
02-284-15
15 cm / 6"

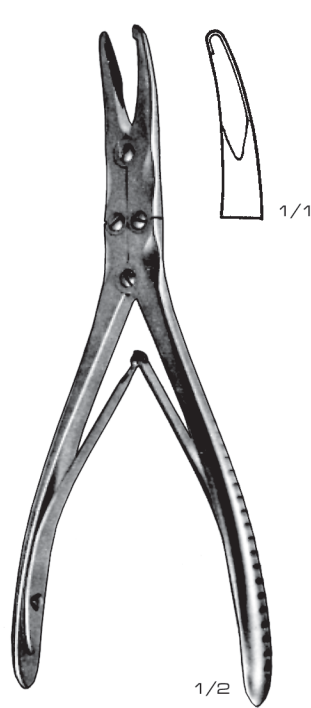

Geiger
02-285-15
15 cm / 6"

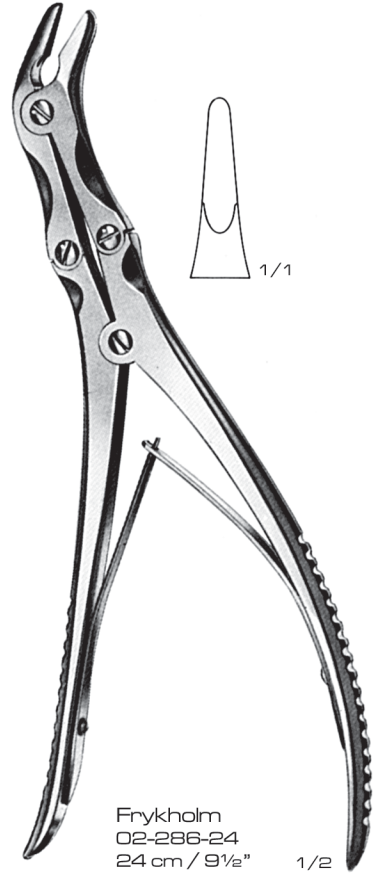

Frykholm
02-286-24
24 cm / 9½" 1/2

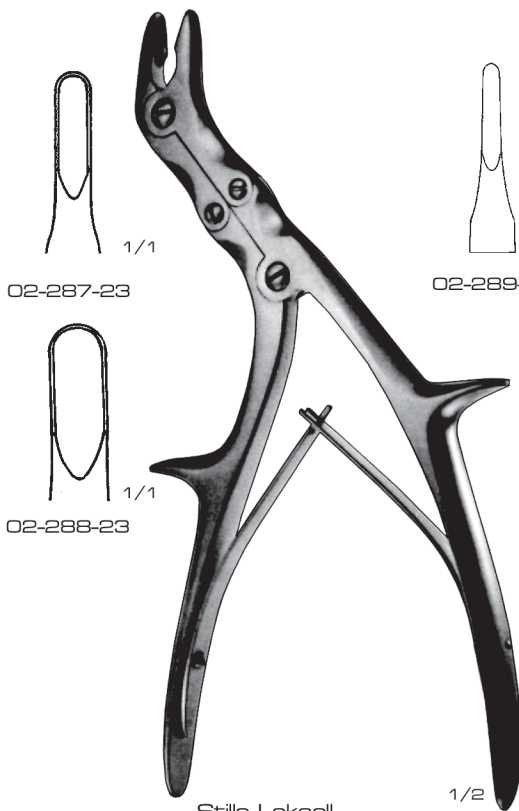

02-287-23

02-288-23

Stille-Leksell
02-287-23 & 02-288-23
28 cm / 9"

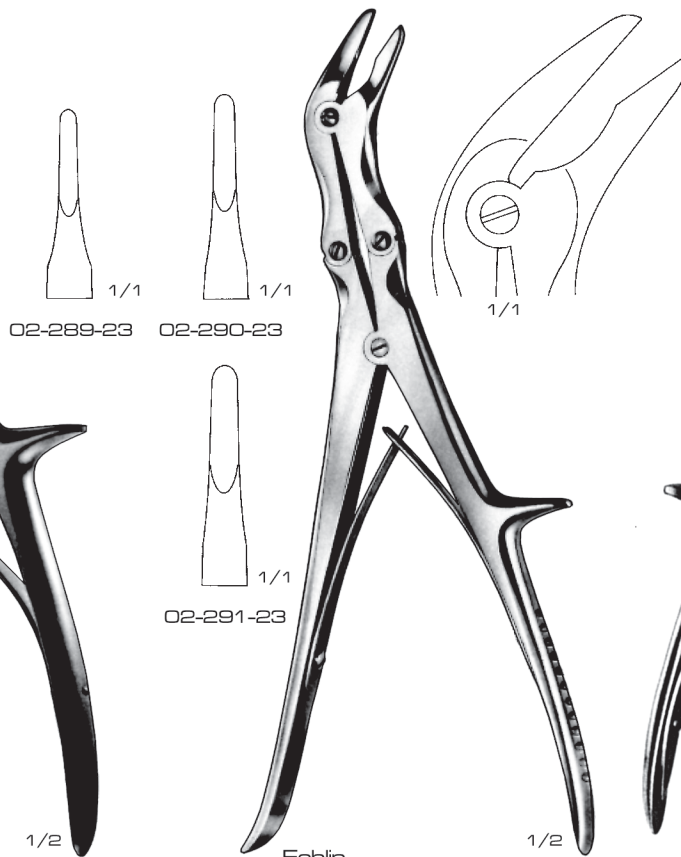

02-289-23

02-290-23

02-291-23

Echlin
02-289-23 To 02-291-23
23 cm / 9"

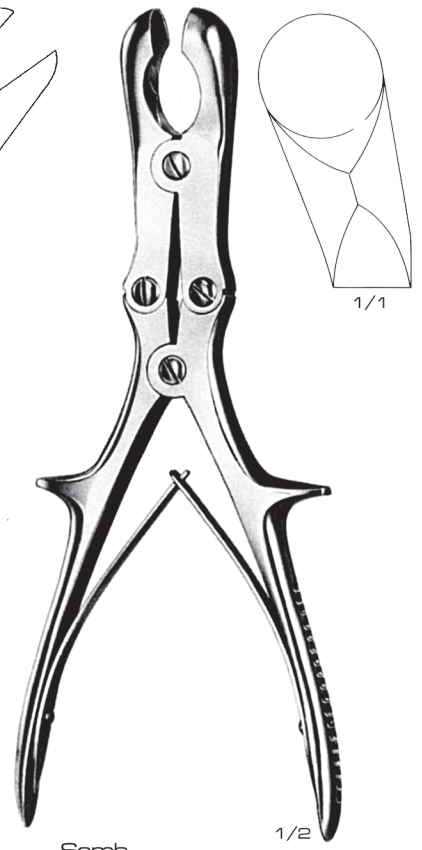

Semb
02-292-23 23 cm / 9"
02-293-27 27 cm / 10½"

BONE RONGEURS



Mayfield
02-294-23 & 02-295-23
23 cm / 9"



Leksell
02-296-23 & 02-297-23
23 cm / 9"



Smith-Petersen
02-298-24
24 cm / 9½"

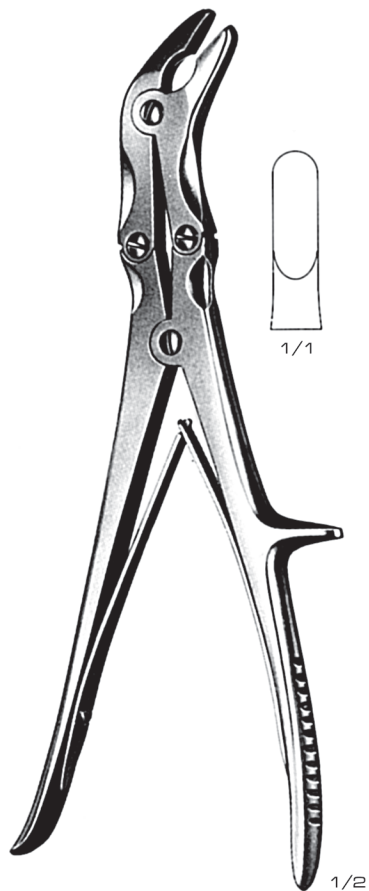

Stille
02-299-235
23.5 cm / 9¼"

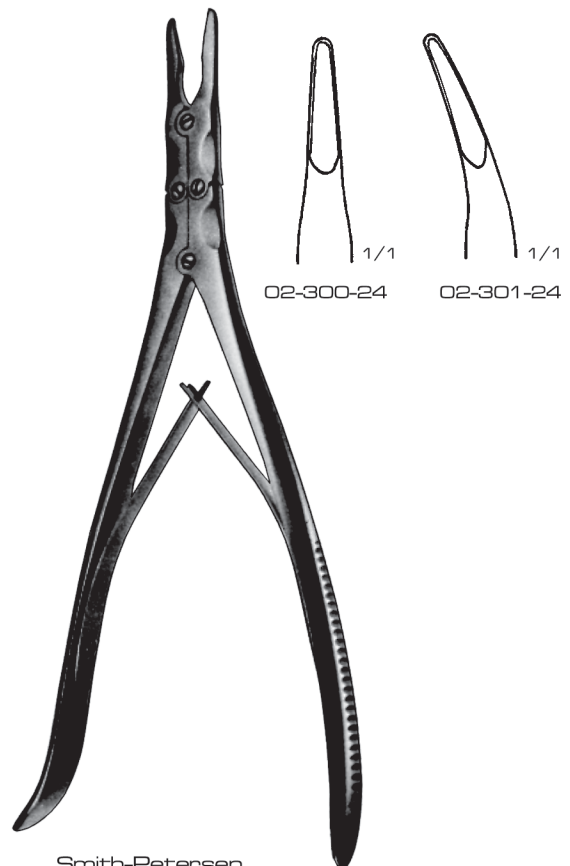

Smith-Petersen
02-300-24 & 02-301-24
24 cm / 9½"



Stille-Luer
02-302-22 & 02-303-22
22 cm / 8³/₄"

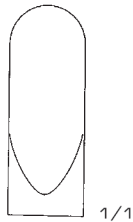

02-302-22

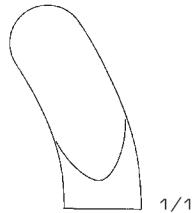

02-303-22



Stille-Ruskin
02-304-23
23 cm / 9"

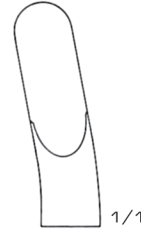

1/1

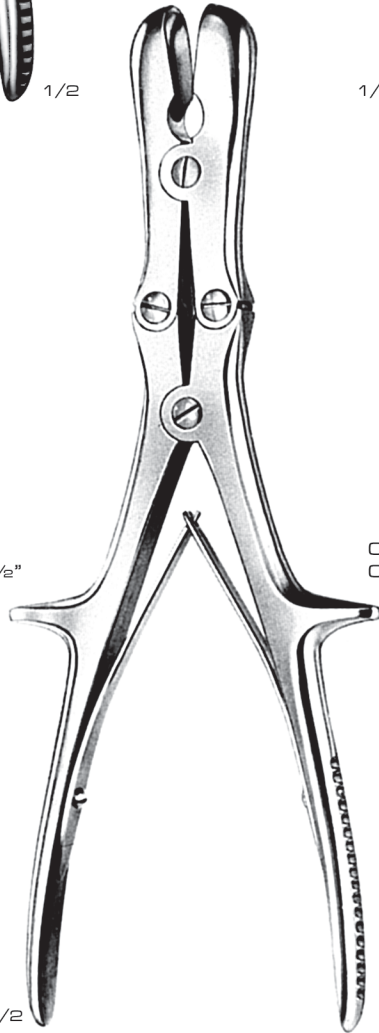

Stille-Luer
02-305-23 To 02-308-27

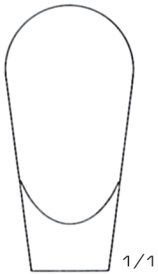

1/1

02-305-23 23 cm / 9"
02-307-27 27 cm / 10¹/₂"



1/1

02-306-23 23 cm / 9"
02-308-27 27 cm / 10¹/₂"



Sybert
02-309-36
36 cm / 14¹/₂"



1/1

BONE RONGEURS

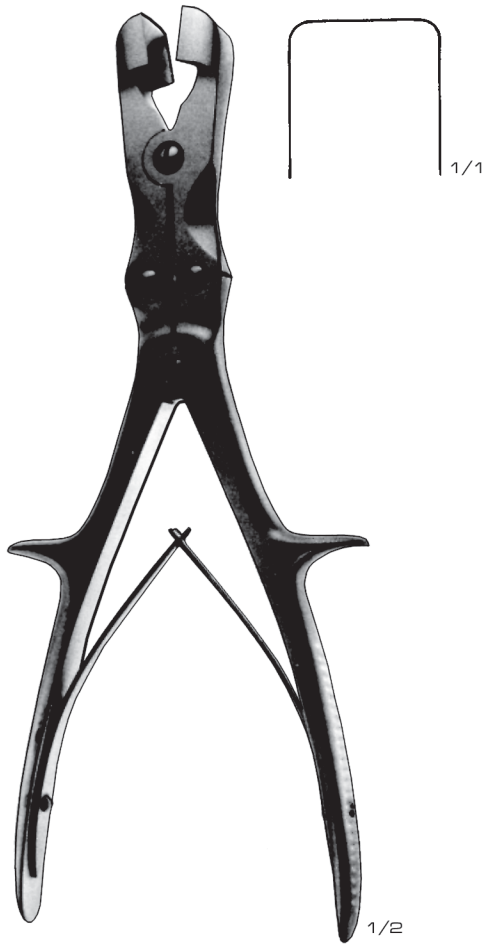

Sauerbruch-Stille
02-310-26
26 cm / 10 1/4"

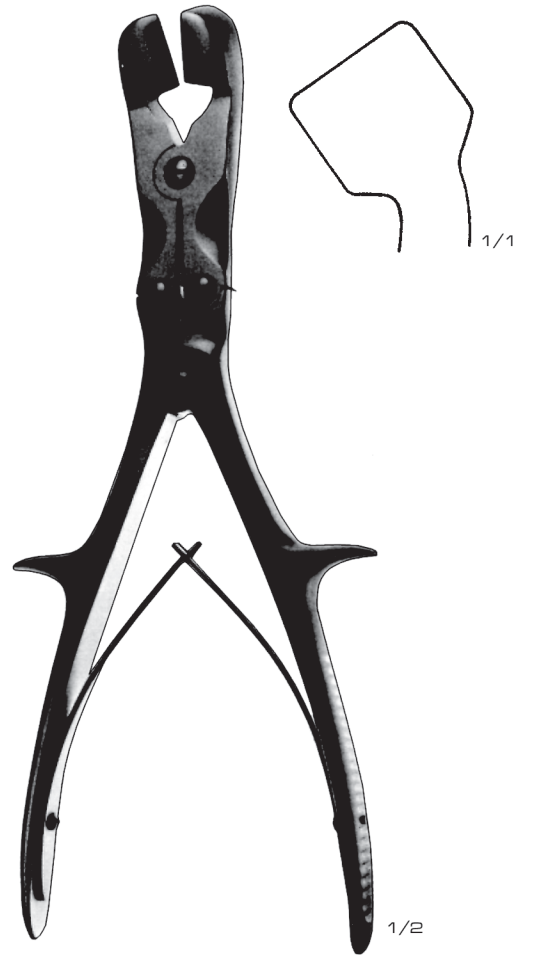

Sauerbruch-Stille
02-311-26
26 cm / 10 1/4"

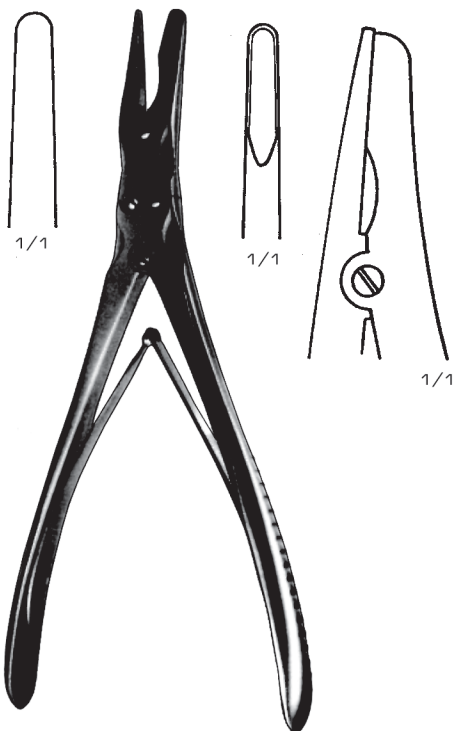

Peiper-Beyer
02-312-18
18 cm / 7"



Sauerbruch-Coryllos
02-313-30 & 02-314-30
30 cm / 12"

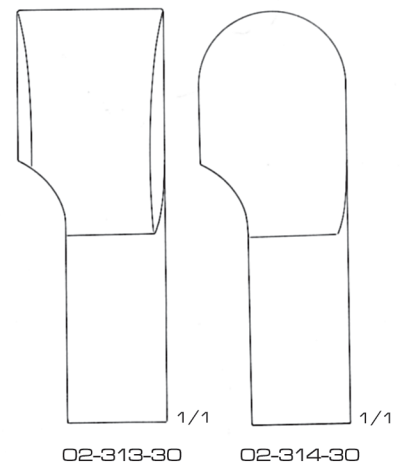



02-315-14
14 cm / 5½"
Drilling chuck for shanks
up to 4.5 mm Ø



02-316-13
13 cm / 5⅛"
Drilling chuck for shanks
up to 4.5 mm Ø
With key

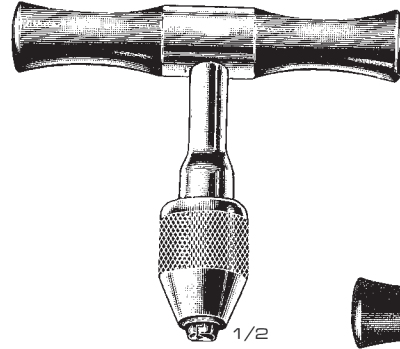

Stienmann
02-317-09
9 cm / 3¼"

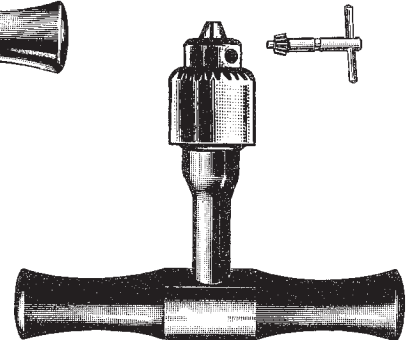

02-318-09
9 cm / 3¼"
With key

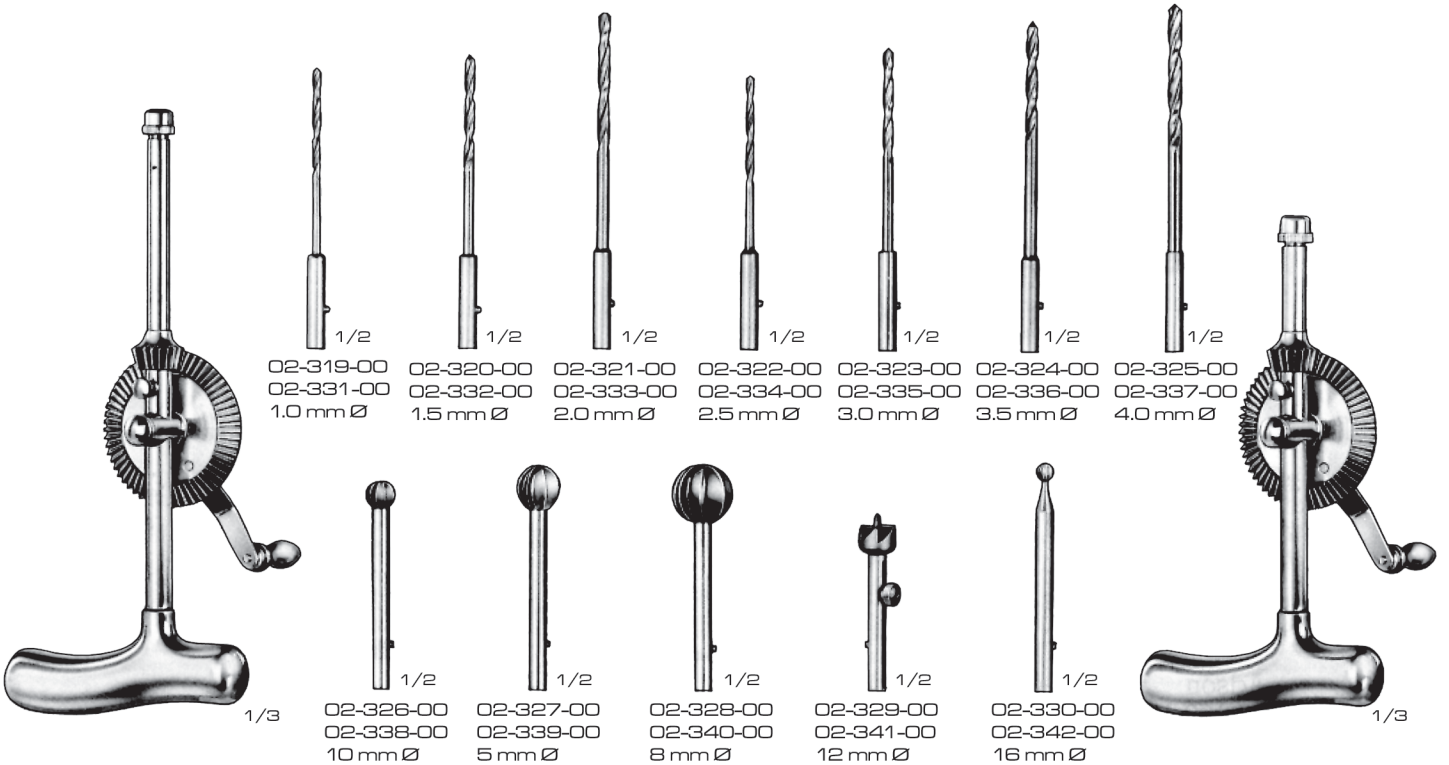

02-319-00	02-320-00	02-321-00	02-322-00	02-323-00	02-324-00	02-325-00
02-331-00	02-332-00	02-333-00	02-334-00	02-335-00	02-336-00	02-337-00
1.0 mm Ø	1.5 mm Ø	2.0 mm Ø	2.5 mm Ø	3.0 mm Ø	3.5 mm Ø	4.0 mm Ø

02-326-00	02-327-00	02-328-00	02-329-00	02-330-00
02-338-00	02-339-00	02-340-00	02-341-00	02-342-00
10 mm Ø	5 mm Ø	8 mm Ø	12 mm Ø	16 mm Ø

Stille-Sherman
02-319-00 To 02-330-00
24 cm / 9½"
With drill

Stille
02-331-00 To 02-342-00
24 cm / 8"
With drill

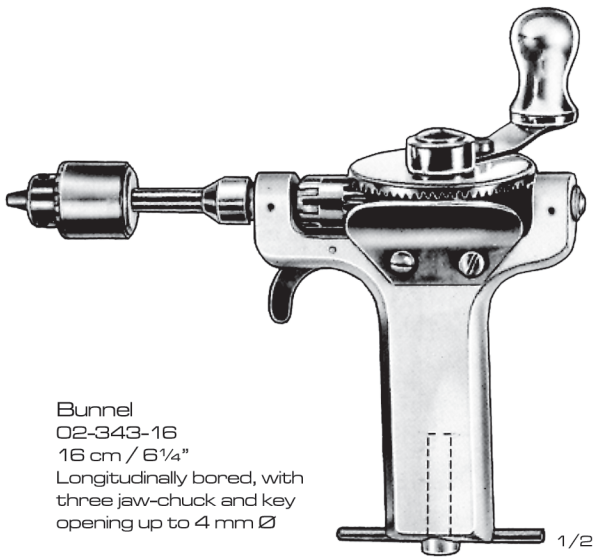

Bunnel
02-343-16
16 cm / 6 1/4"
Longitudinally bored, with
three jaw-chuck and key
opening up to 4 mm Ø

1/2

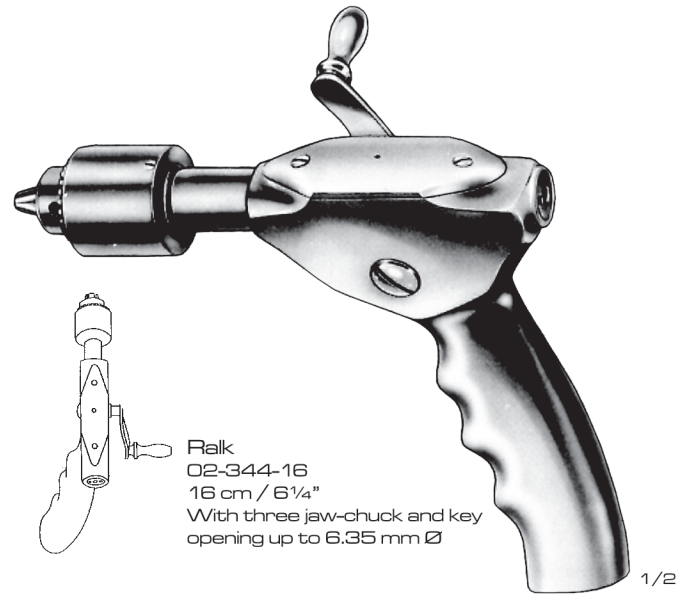

Falk
02-344-16
16 cm / 6 1/4"
With three jaw-chuck and key
opening up to 6.35 mm Ø

1/2

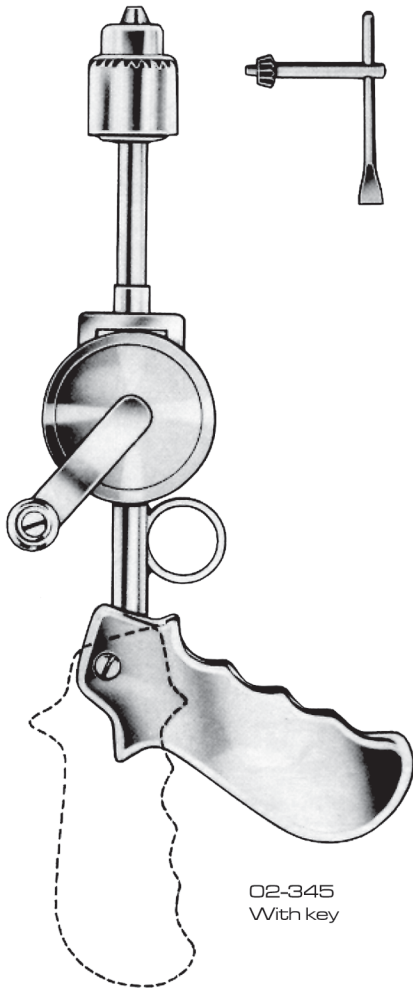

02-345
With key



02-346-28
28 cm / 11"

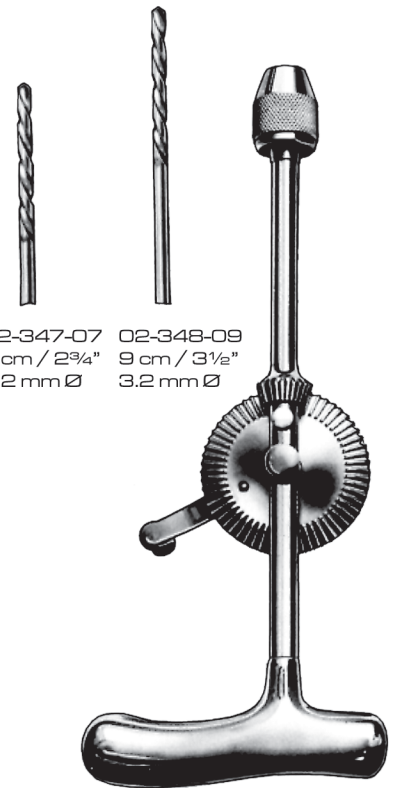

02-347-07 02-348-09
7 cm / 2 3/4" 9 cm / 3 1/2"
3.2 mm Ø 3.2 mm Ø

Moore
02-347-07 & 02-348-09
With 1 drill
02-349-285
28.5 cm / 11 1/4"
with 3 drills

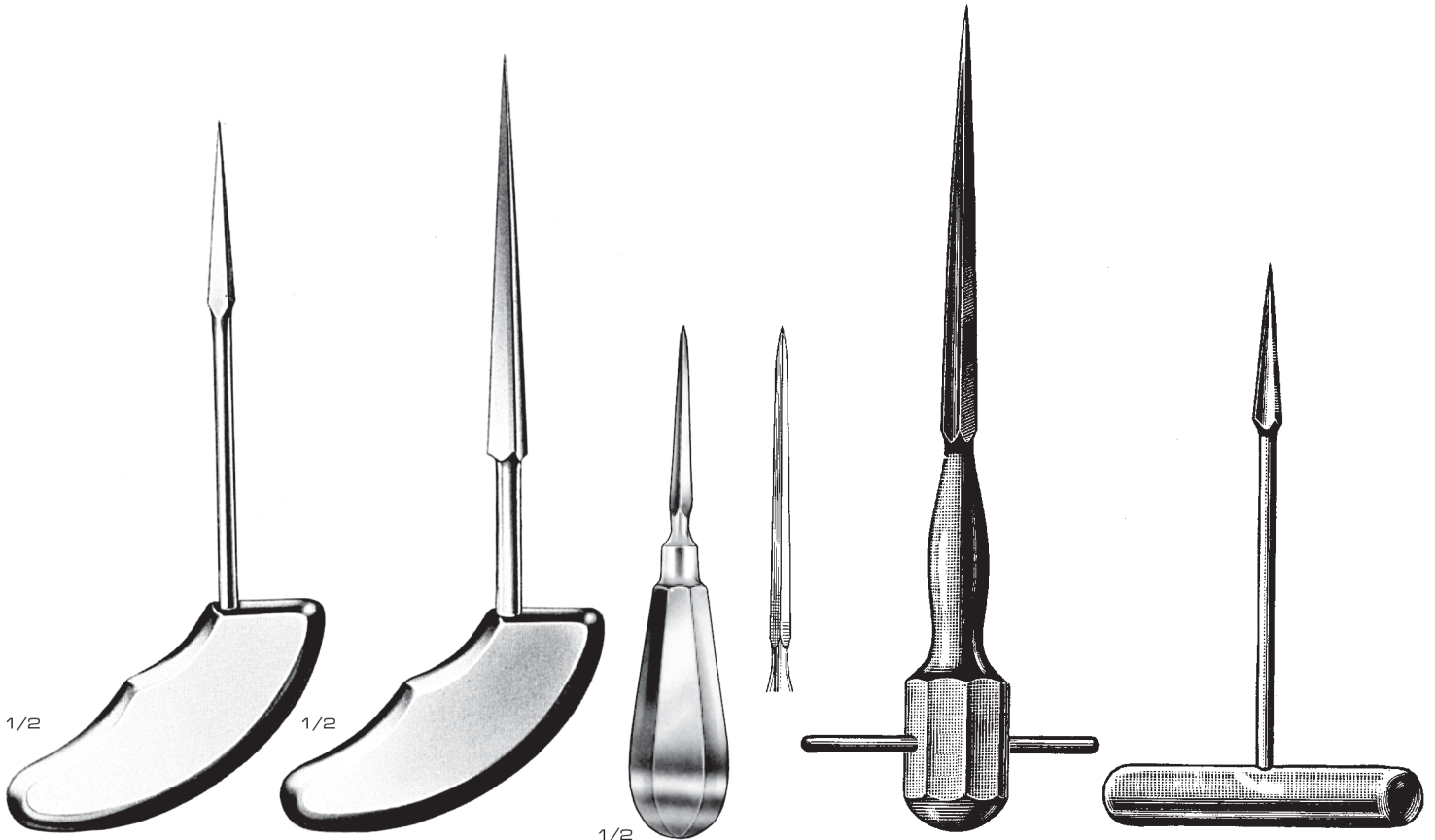

1/2

1/2

1/2

Perthes
02-350-18
18 cm / 7"

Perthes
02-351-21
21 cm / 8 1/4"

02-352-14
14 cm / 5 1/2"

Perthes
02-353-21
21 cm / 8 1/4"

02-354-15
15 cm / 6"



1/3

1/3

1/3

1/3

1/3

02-355-00
Extension
piece

02-356-00
9 mm Ø

02-357-00
14 mm Ø

02-358-00
16 mm Ø

02-359-00
22 mm Ø

1/1

1/3

1/3

1/3

1/3

1/3

Cushing
02-360-00
14 mm Ø

02-361-00
2 mm Ø

Mckenzie
02-362-00
13 mm Ø

Enrico
02-363-00
16 mm Ø

1/2

1/2

1/2

02-365-17
17 cm / 6 3/4"

02-366-17
17 cm / 6 3/4"

Hudson
02-355-00 To 02-363-00
27 cm / 10 1/2"
02-364-00
With 8 drills and
extension piece

SCREW DRIVERS AND BONE PLATE BENDERS

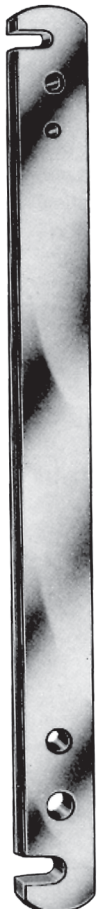
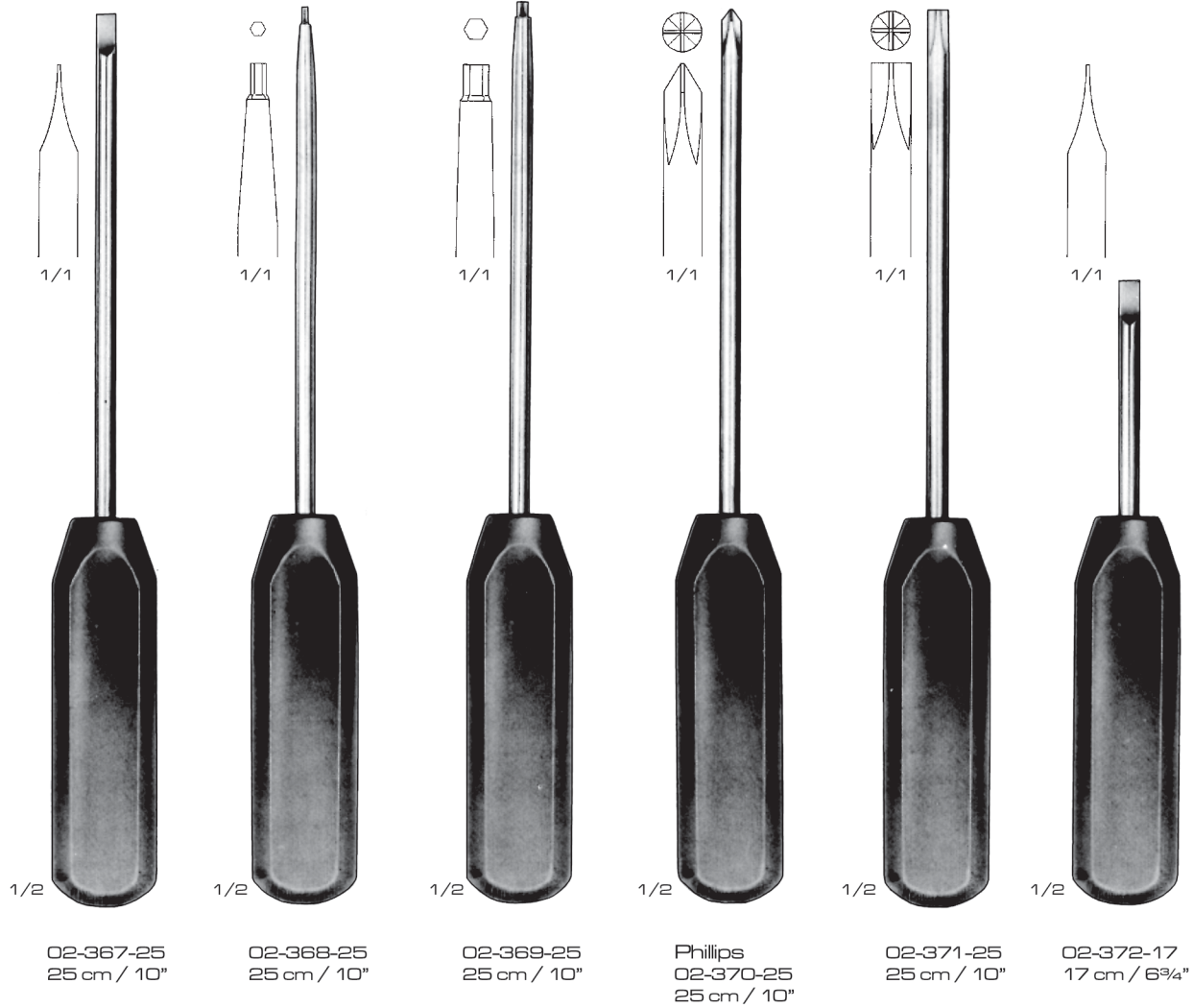

02-373-24
24 cm / 9 1/2"

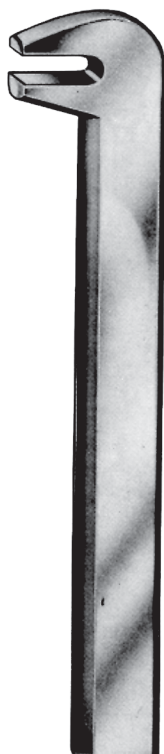

Jewett
02-374-20
20 cm / 8"

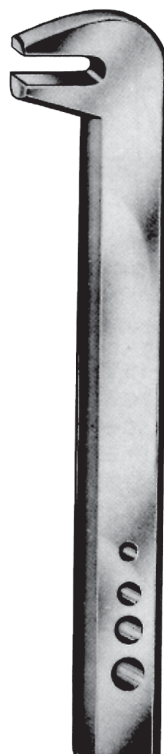

Jewett
02-375-20
20 cm / 8"

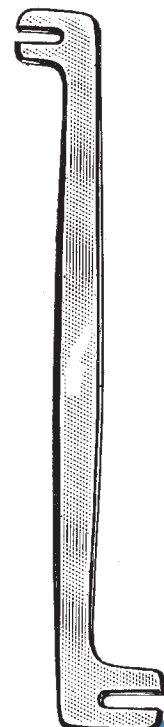

Lane
02-376-18
18 cm / 7"



- 02-377-00 15 mm
- 02-378-00 20 mm
- 02-379-00 25 mm
- 02-380-00 30 mm
- 02-381-00 35 mm
- 02-382-00 40 mm
- 02-383-00 45 mm
- 02-384-00 50 mm
- 02-385-00 55 mm
- 02-386-00 60 mm
- 02-387-00 65 mm
- 02-388-00 70 mm

Palmer
02-377-00 To 02-388-00
1.5 mm Ø



02-389-00

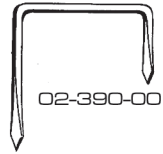

02-390-00

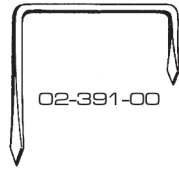

02-391-00

Wilberg
02-389-00 To 02-391-00
Clips



Kirschner
02-392-06
6 x 6 cm . 2 1/2" x 2 1/2"
With 3 traction hooks

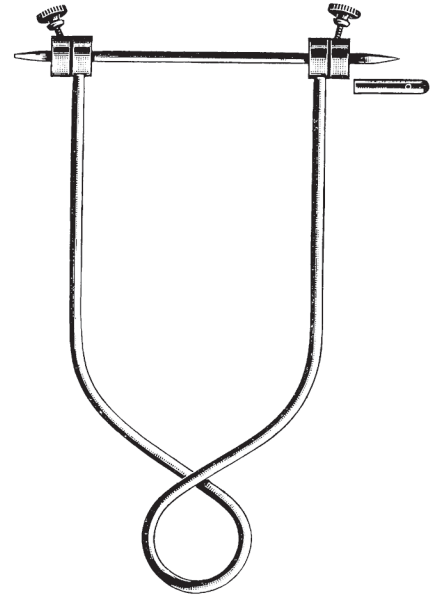

Bohler
02-393-16
16 x 9 cm 6 1/4" x 3 1/4"
For Arm with 1 pin
02-394-21
21 x 11 cm 8 1/4" x 4 1/2"
For thigh and knee with 1 pin
02-395-21
21 x 11 cm 8 1/4" x 4 1/2"
For femur and knee with 1 pin

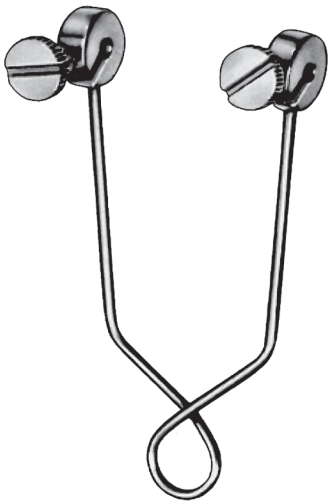

Schwartz
02-396-00
up to 1.6 mm Ø

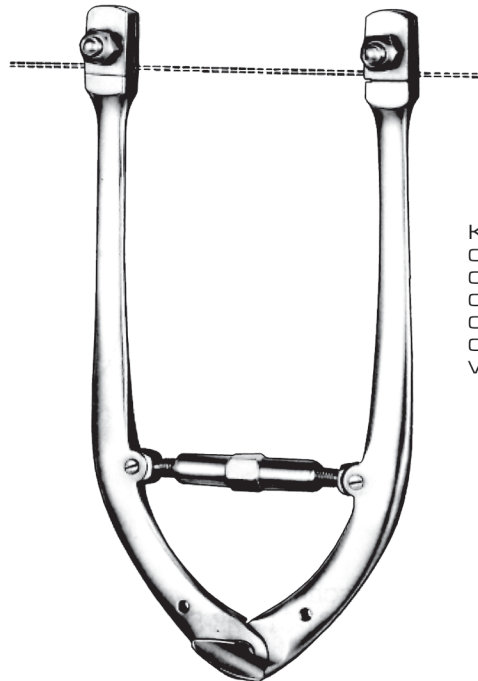

Kirschner
02-397-00 4-14 x 11.5 cm / 1 1/2" - 5 1/2" x 4 1/2"
02-398-00 6.5-15 x 11 cm / 2 1/2" - 6" x 4 1/4"
02-399-00 6-22 x 18 cm / 2 1/4" - 8 3/4" x 7"
02-400-00 18 x 10 cm / 7" x 4"
02-401-00 27 x 27 cm / 10 1/2" x 10 1/2"
With 3 traction hooks



Kuntscher
02-402-45
45 cm / 17³/₄"
With 4 tips

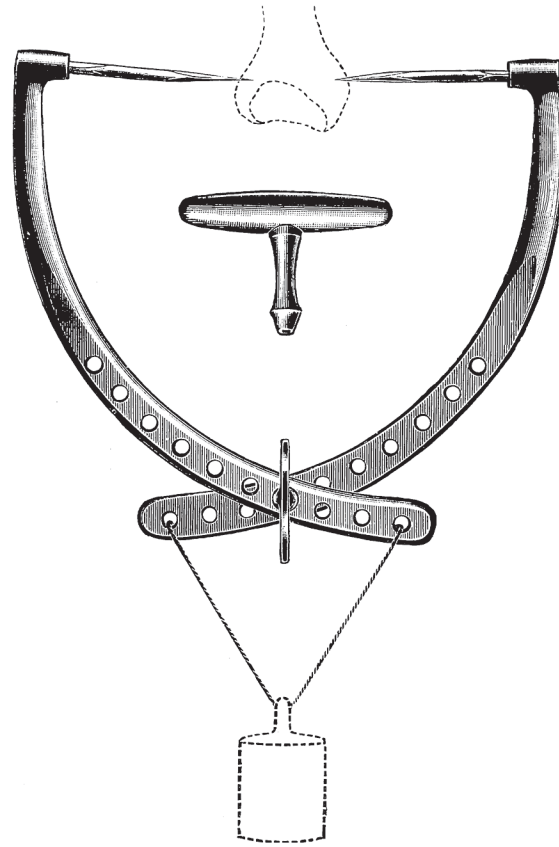

Steinmann
02-403-00
Complete consisting :
1 Key, 2 Pins 8 mm, 2 Pins 10 mm,
2 Pins 12 mm, 2 Pins 14 mm,
2 Pins 16 mm, 2 Pins 20 mm

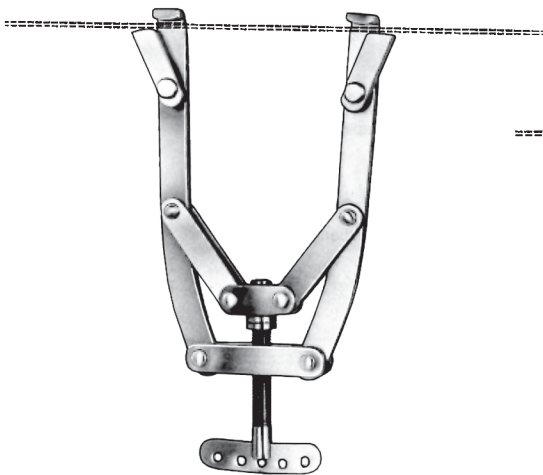

Kirschner
02-404-185
0-40 mm x 18.5 cm / 7¹/₄"
02-405-27
35-200 mm x 27 cm / 10¹/₂"
With 3 traction pins

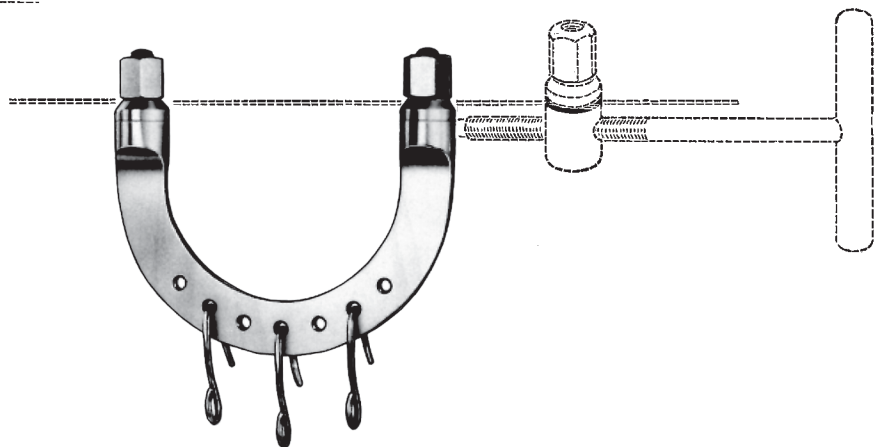

Kirschner
02-406-00 9.5 x 7 cm / 3³/₄ x 2³/₄"
02-407-00 10.5 x 10.5 cm / 4¹/₄ x 4¹/₄"
02-408-00 12 x 12 cm / 4³/₄ x 4³/₄"
02-409-00 15 x 15 cm / 6 x 6"
02-410-00 20 x 15 cm / 8 x 6"
With 3 traction pins

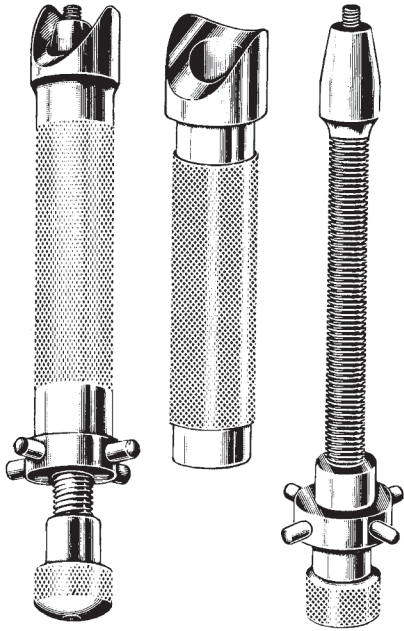

Lloyd
02-411-20
Impactor and Extractor
20 cm / 8"

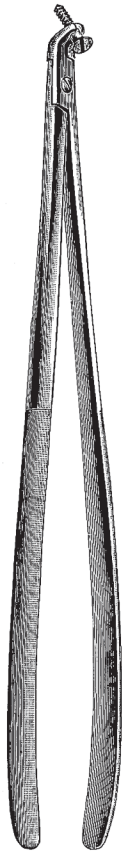

Lane
02-412-23
23 cm / 9"

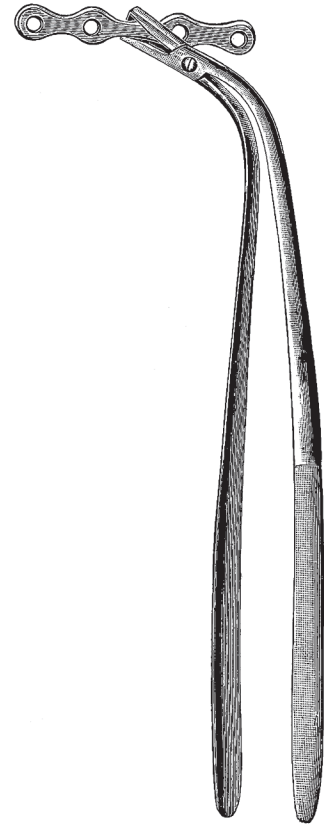

Lane
02-413-22
22 cm / 8¾"



Loute
02-414-22
22 cm / 8¾"

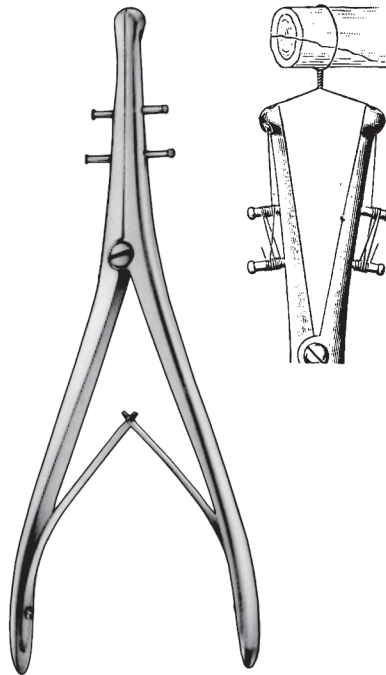

Parham
02-415-27
27 cm / 10½"



Parham
02-416-18 18 cm / 7" X 5 mm
02-417-20 20 cm / 8" X 5 mm
02-418-25 25 cm / 10" X 3 mm
02-419-27 27 cm / 10½" X 5 mm
02-420-30 30 cm / 12" X 5 mm

FLAT NOSE WIRE TIGHTENING PLIERS

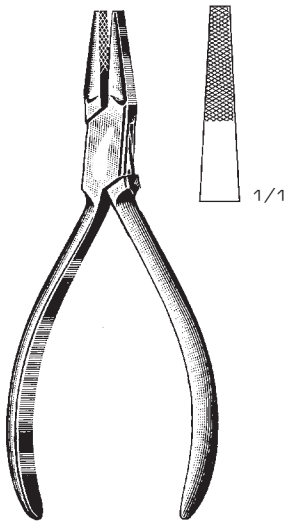

02-421-14
14 cm / 5½"

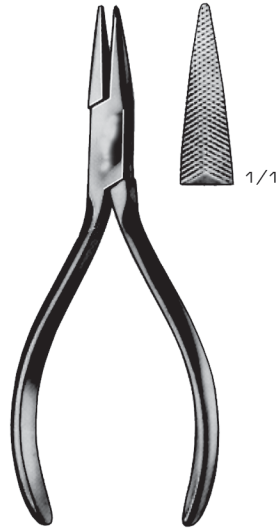

02-422-14
14 cm / 5½"



02-423-16
16 cm / 6¼"

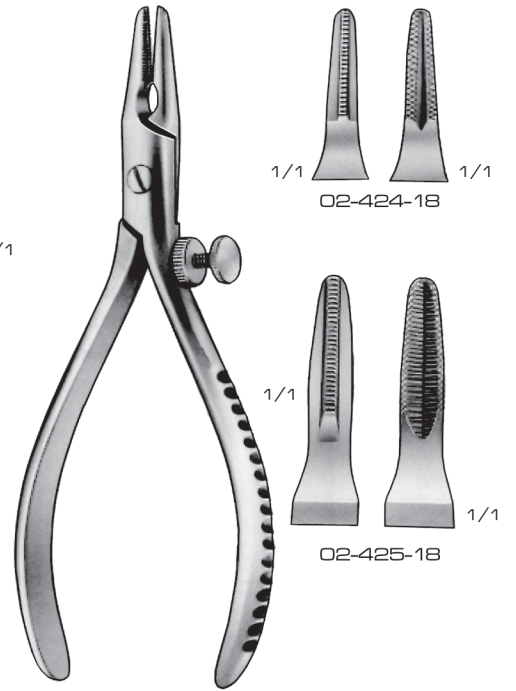

02-424-18 & 02-425-18
18 cm / 7"



02-426-165
16.5 cm / 6½"



02-427-16
16 cm / 6¼"

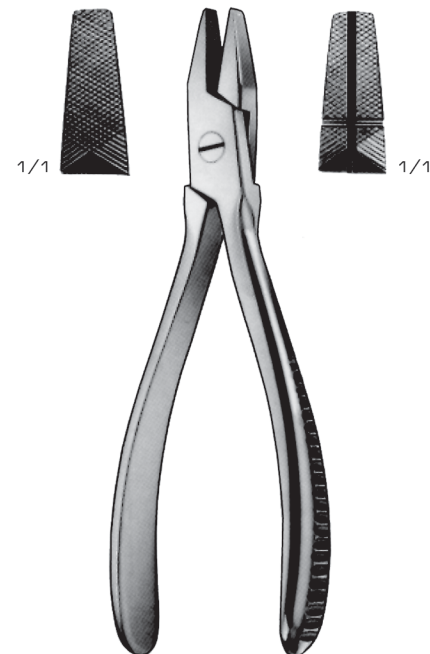

02-428-17
17 cm / 6¾"

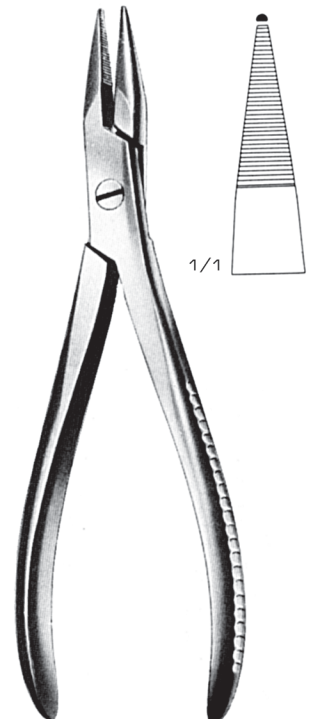

02-429-19
19 cm / 7½"



1/1



02-430-17
17 cm / 6 3/4"



1/1



02-431-18 To 02-433-18
18 cm / 7"

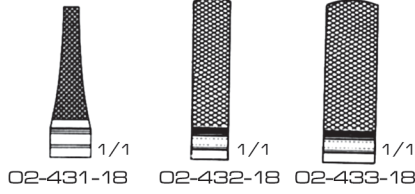

02-431-18 1/1

02-432-18 1/1

02-433-18 1/1

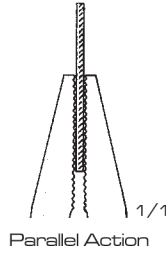

Parallel Action 1/1



1/1

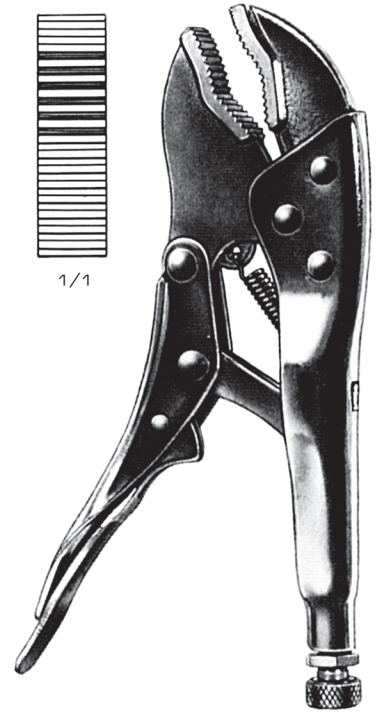

02-434-18
18 cm / 7"
02-434-20
20 cm / 8"

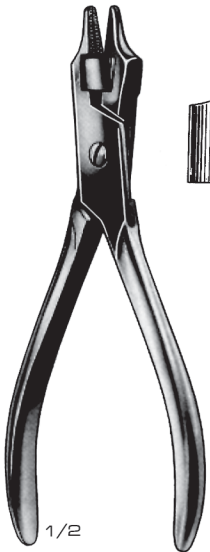

1/2

02-435-15
15 cm / 6"

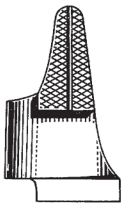

1/1



1/2

02-436-16
16 cm / 6 1/4"



1/1



02-437-18 To 02-439-18
18 cm / 7"



1/1



1/1



1/1

02-439-18

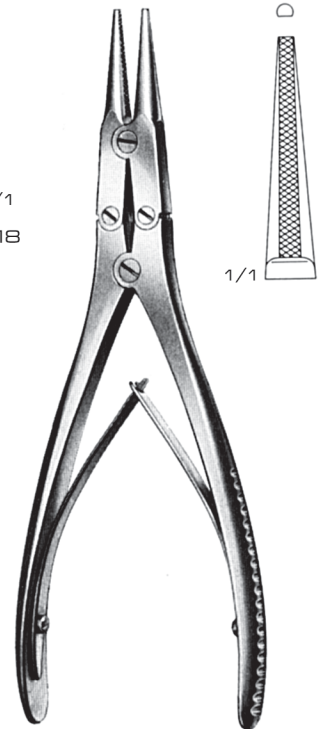

02-440-18
18 cm / 7"

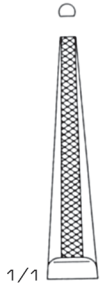

1/1

GOLD LINE

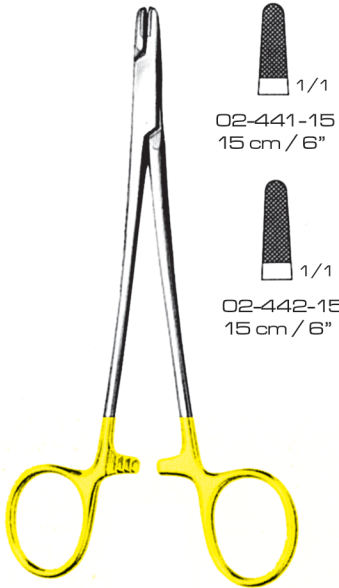

1/1
02-441-15
15 cm / 6"

1/1
02-442-15
15 cm / 6"

02-441-15 & 02-442-15
15 cm / 6"

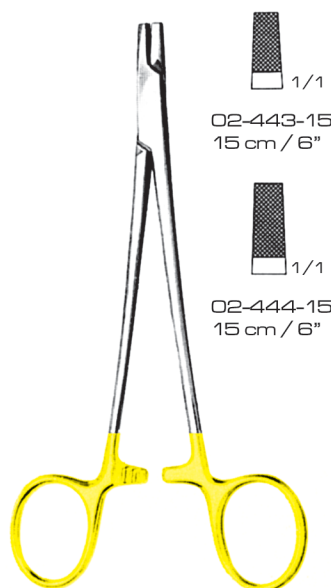

1/1
02-443-15
15 cm / 6"

1/1
02-444-15
15 cm / 6"

02-443-15 & 02-444-15
15 cm / 6"



1/1

02-445-15
15 cm / 6"



1/1

02-446-20
20 cm / 8"

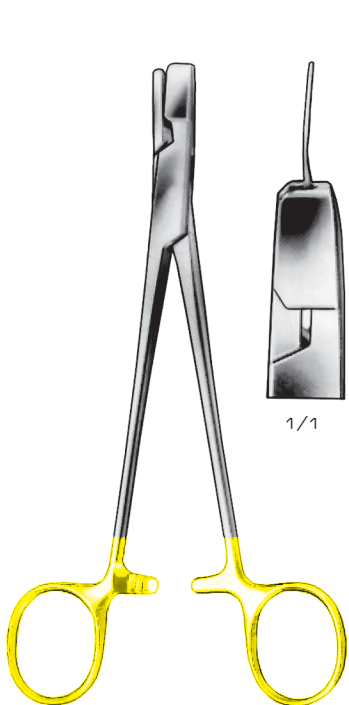

1/1

02-447-17
17 cm / 6 3/4"

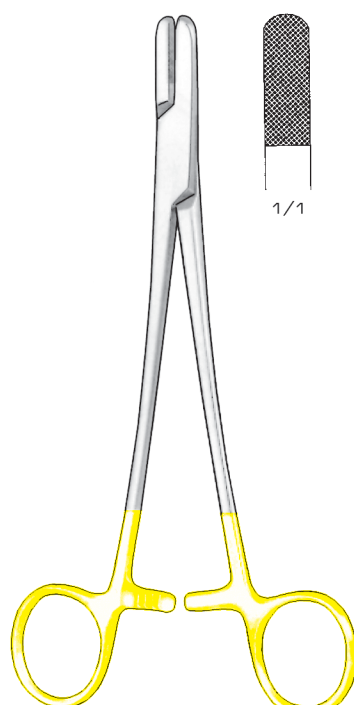

1/1

02-448-185
18.5 cm / 7 1/4"



1/1 1/1 1/1
02-449-18 02-450-18 02-451-18

02-449-18 To 02-451-18
18 cm / 7"

GOLD LINE

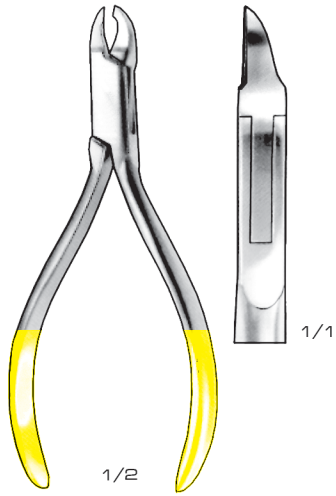

Angle
02-452-13
13 cm / 5 1/8"



02-453-14
14 cm / 5 1/2"



02-454-14
14 cm / 5 1/2"
02-454-18
18 cm / 7"

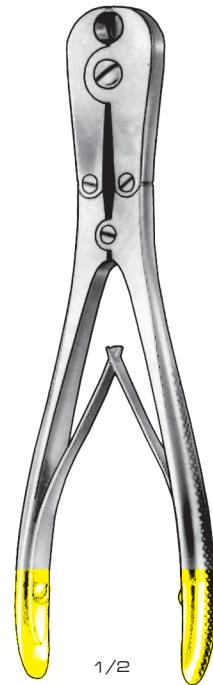

02-455-18
18 cm / 7"



For soft wires
up to 2.0 mm Ø

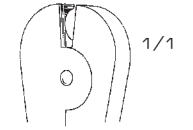

For soft wires
up to 1.5 mm Ø

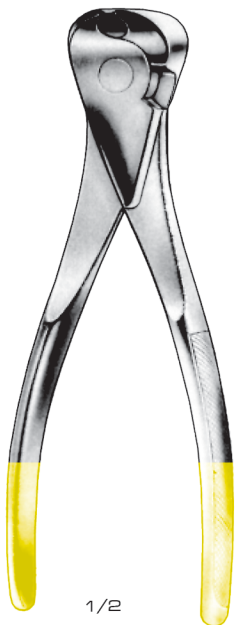

02-456-16
16 cm / 6 1/4"

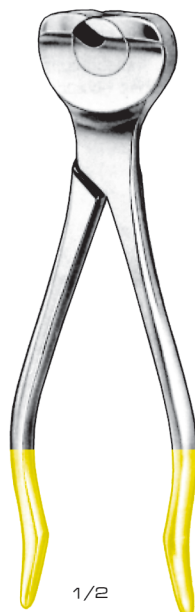

02-457-16
16 cm / 6 1/4"



02-458-145
14.5 cm / 5 3/4"



02-459-145
14.5 cm / 5 3/4"

WIRE CUTTING PLIERS

GOLD LINE



For hard wires
up to 1.0 mm Ø

For soft wires
up to 1.6 mm Ø

1/2

02-460-16
16 cm / 6¼"



For hard wires
up to 1.6 mm Ø

For soft wires
up to 2.0 mm Ø

1/1

1/2

Reill
02-461-18
18 cm / 7"

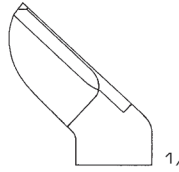

For hard wires
up to 2.23 mm Ø

For soft wires
up to 2.5 mm Ø

1/1

1/2

02-462-22
22 cm / 8¾"

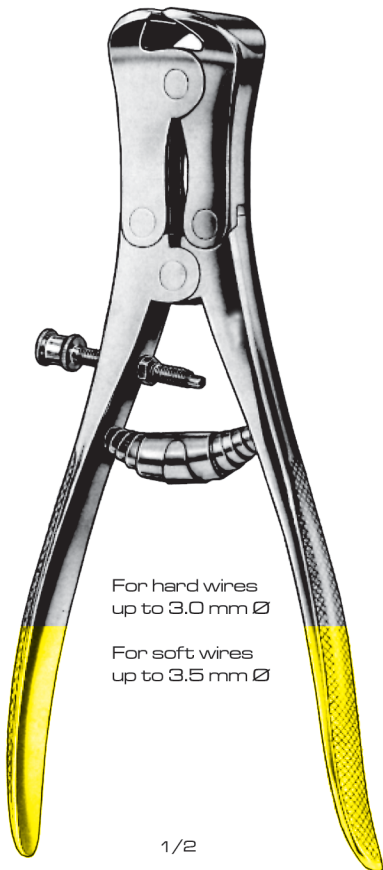

For hard wires
up to 3.0 mm Ø

For soft wires
up to 3.5 mm Ø

1/2

02-463-23
23 cm / 9"



1/2

02-464-25
25 cm / 10"

For hard wires
up to 3.0 mm Ø

For soft wires
up to 3.5 mm Ø

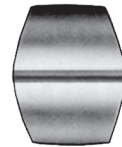
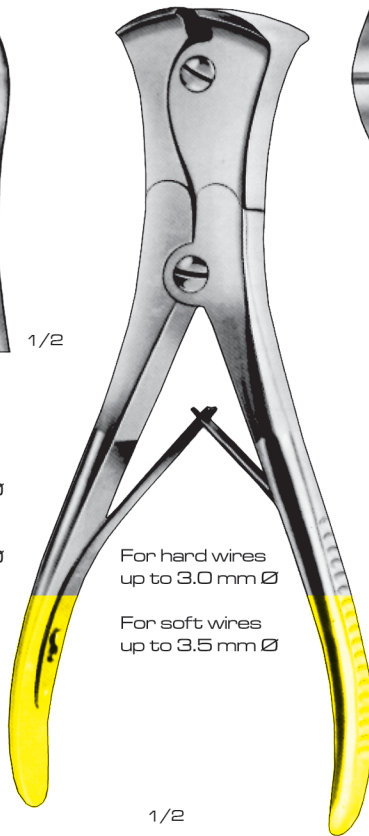

1/2

For hard wires
up to 3.0 mm Ø

For soft wires
up to 3.5 mm Ø

1/2

02-465-22
22 cm / 8¾"



For hard wires
up to 2.5 mm Ø

For soft wires
up to 3.0 mm Ø

02-466-235
23.5 cm / 9¼"



For cutting off
Kirschner wires
Tibia head screw,
bolts, pins
up to 3 mm Ø

GOLD LINE

GOLD LINE



02-467-32
32 cm / 12³/₄"



02-468-30 30 cm / 12"
for wire upto 4.0 mm Ø
02-469-47 47 cm / 18¹/₂"
for wire upto 5.0 mm Ø
02-470-56 56 cm / 22"
for wire upto 6.0 mm Ø



02-471-30 30 cm / 12"
for wire upto 4.0 mm Ø
02-472-47 47 cm / 18¹/₂"
for wire upto 5.0 mm Ø
02-473-56 56 cm / 22"
for wire upto 6.0 mm Ø

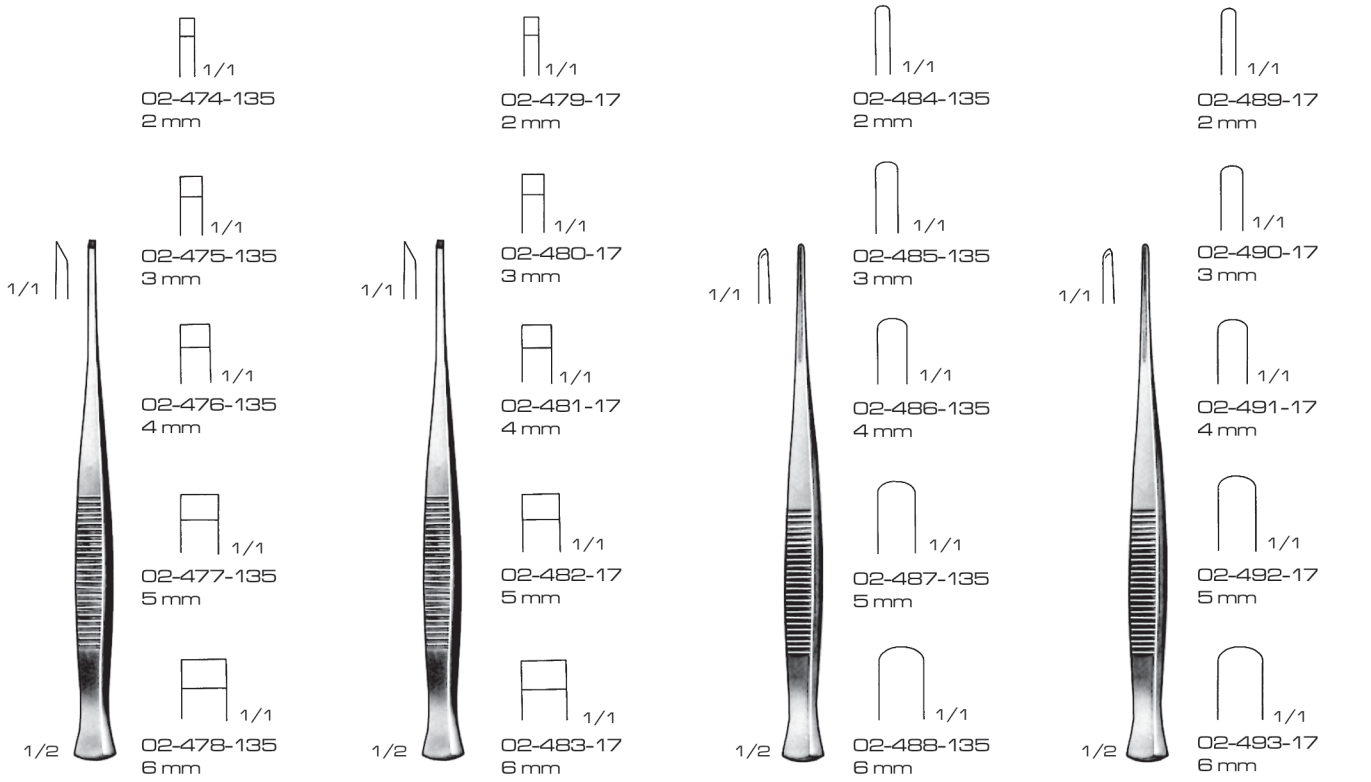

Partsch
02-474-135 To 02-478-135
13.5 cm / 5¼"

Partsch
02-479-17 To 02-483-17
17 cm / 6¾"

02-484-135 To 02-488-135
13.5 cm / 5¼"

02-489-17 To 02-493-17
17 cm / 6¾"

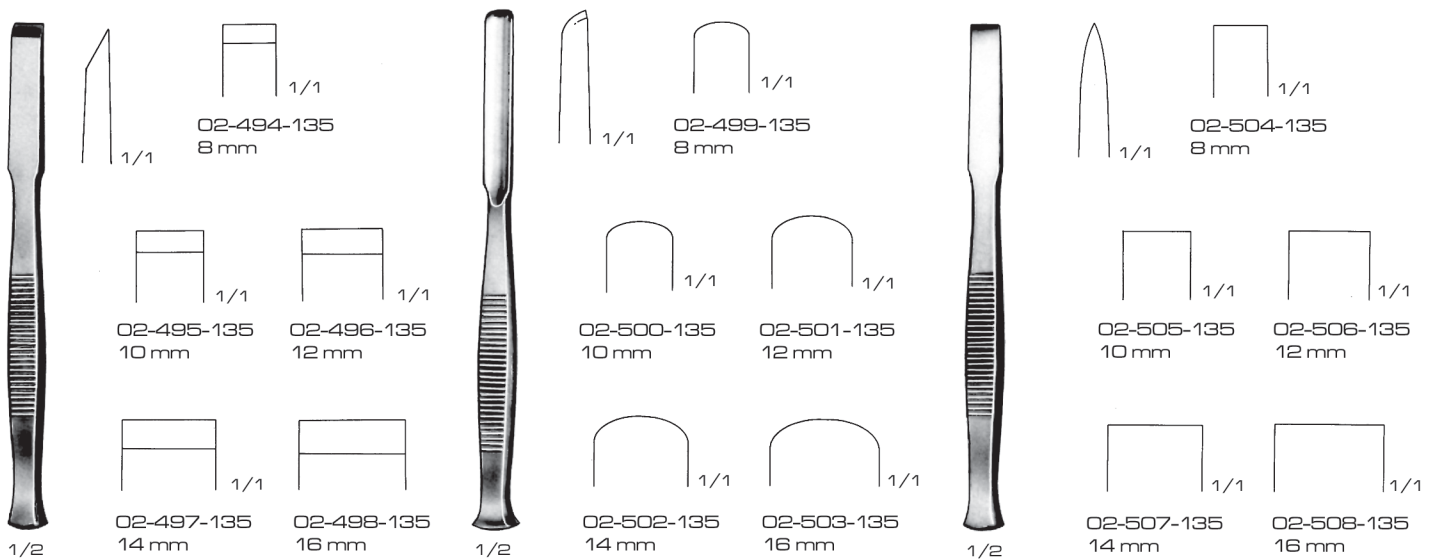

02-494-135 To 02-498-135
13.5 cm / 5¼"

02-499-135 To 02-503-135
13.5 cm / 5¼"

02-504-135 To 02-508-135
13.5 cm / 5¼"

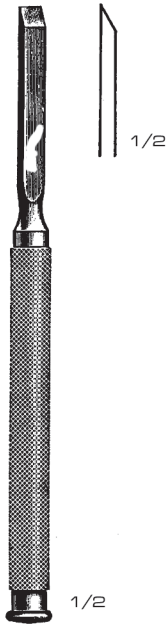

Bruenings (Lucas)
02-509-16 4 mm
02-510-16 6 mm
02-511-16 8 mm
02-512-16 10 mm
16 cm / 6 1/4"

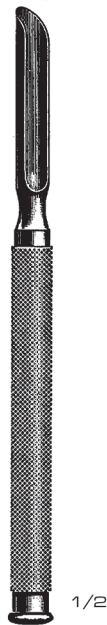

Bruenings (Lucas)
02-513-16 4 mm
02-514-16 6 mm
02-515-16 8 mm
02-516-16 10 mm
16 cm / 6 1/4"

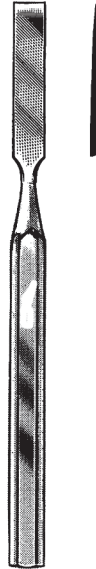

Hoke
02-517-14 3 mm
02-518-14 4.5 mm
02-519-14 6 mm
02-520-14 8 mm
02-521-14 10 mm
02-522-14 12 mm
14 cm / 5 1/2"

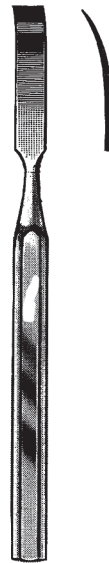

Hoke
02-523-14 3 mm
02-524-14 4.5 mm
02-525-14 6 mm
02-526-14 8 mm
02-527-14 10 mm
02-528-14 12 mm
14 cm / 5 1/2"

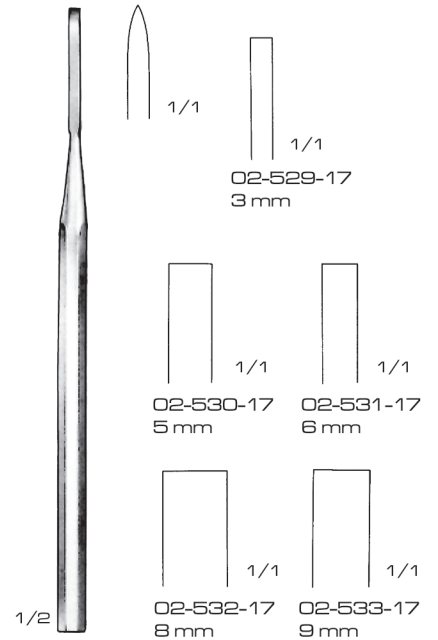

Hoke
02-529-17 To 02-533-17
17 cm / 6 3/4"

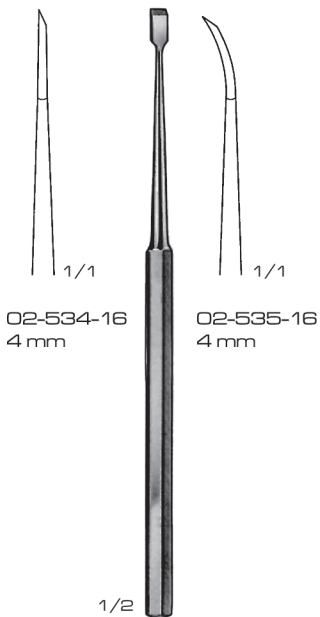

02-534-16 4 mm
02-535-16 4 mm

Freer
02-534-16 & 02-535-16
16 cm / 6 1/4"



West
02-536-17
16 cm / 6 1/4"
4 mm



West
02-537-17
16 cm / 6 1/4"
4 mm



Bishop
02-538-15 2 mm
02-539-15 3 mm
02-540-15 4 mm
02-541-15 5 mm
02-542-15 6 mm
02-543-15 8 mm
15 cm / 6"

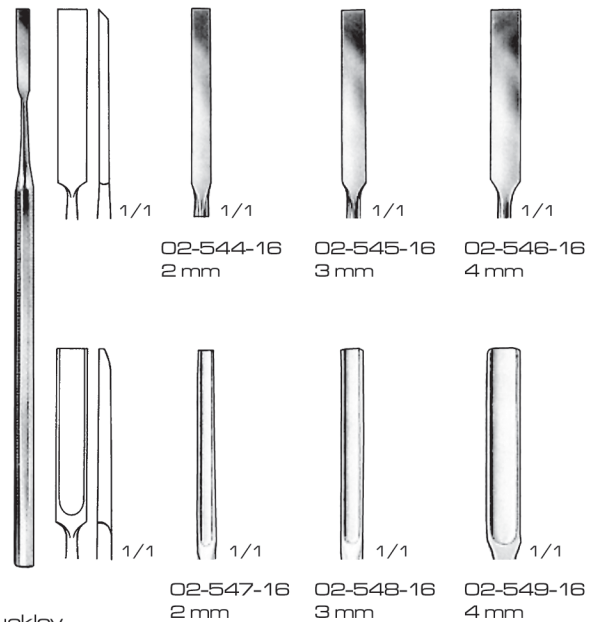

Buckley
02-544-16 To 02-549-16
16 cm / 6 1/4"

BONE CHISSELS, GOUGES AND OSTEOTOMES

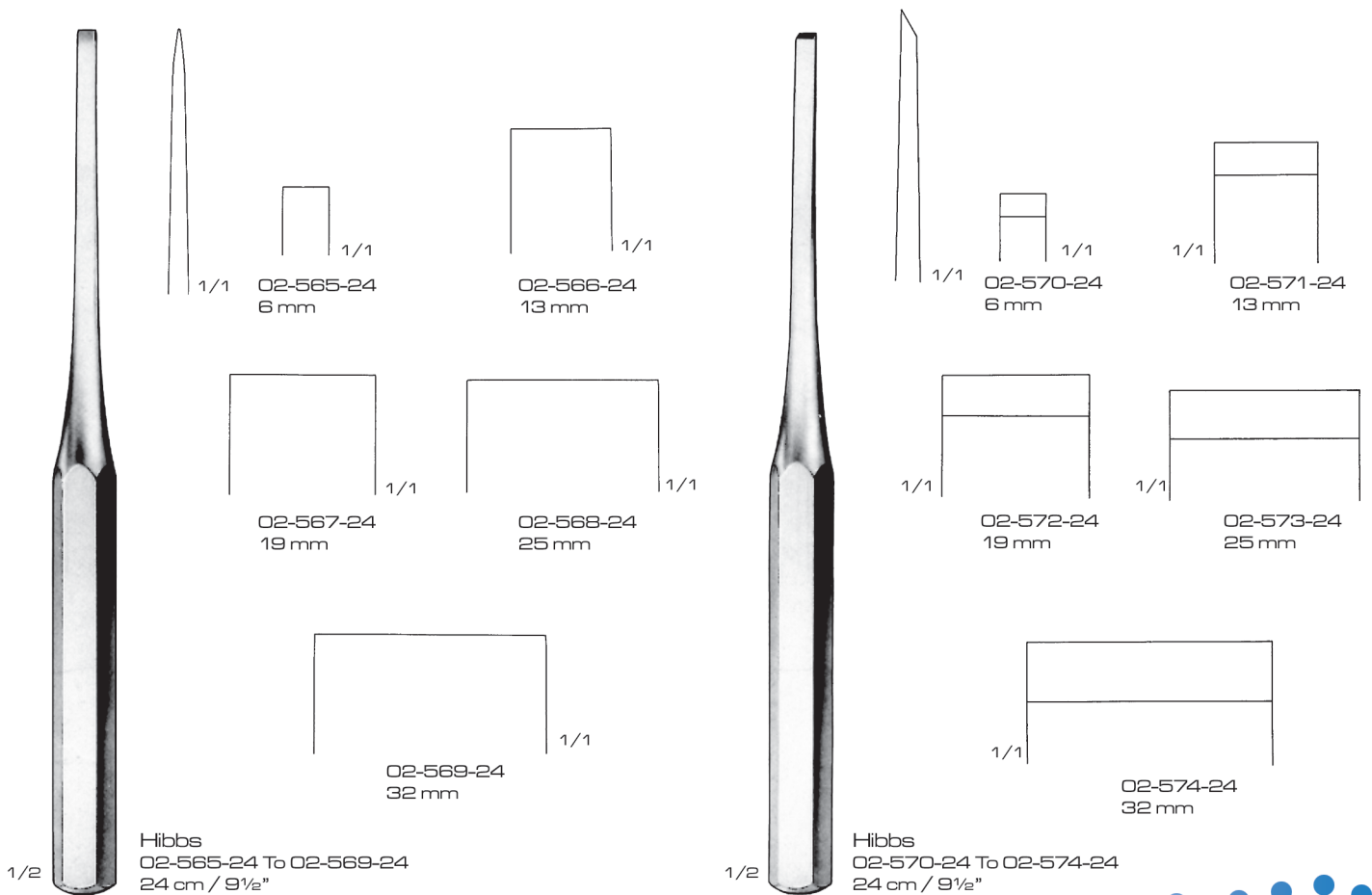
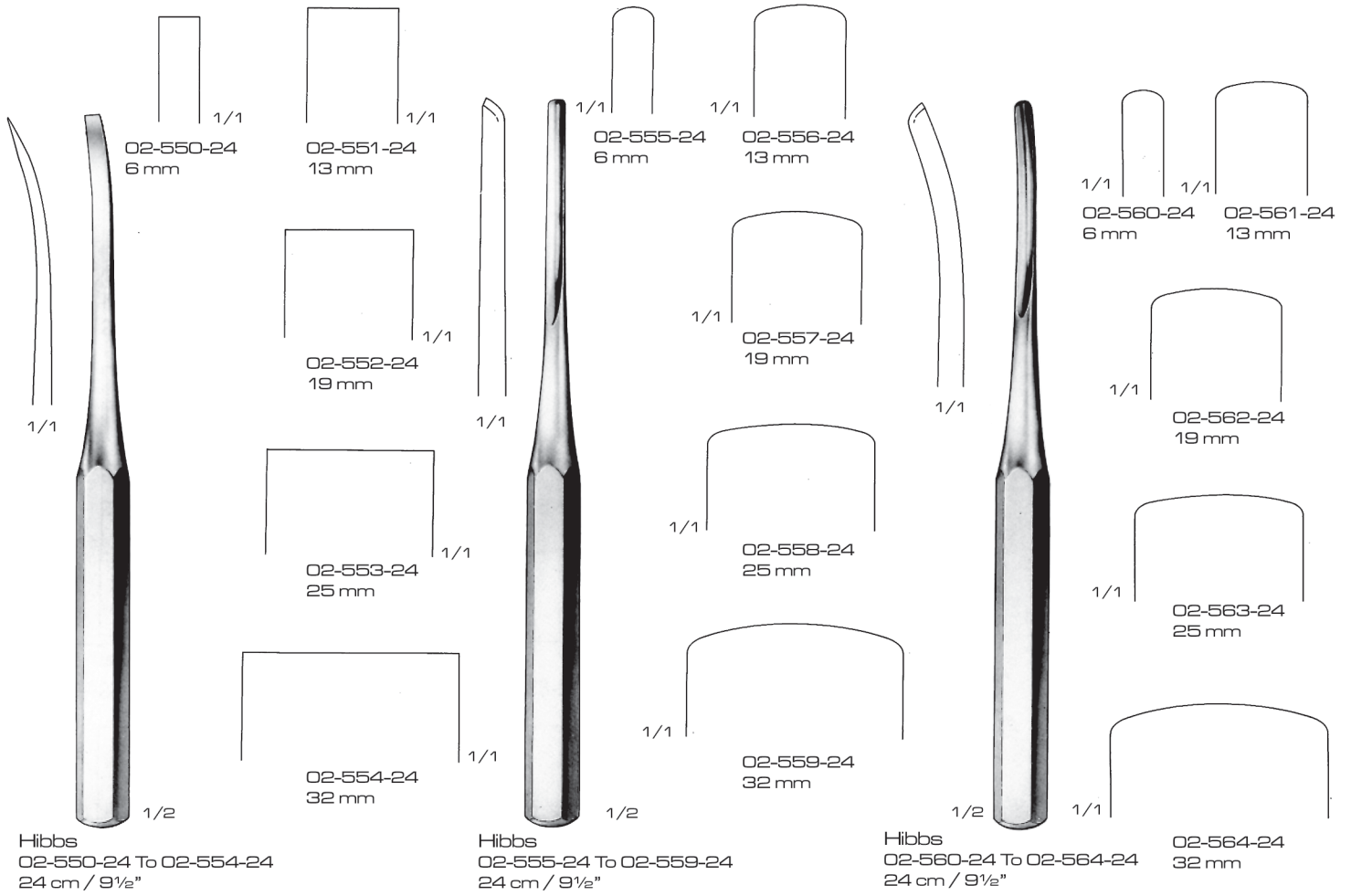

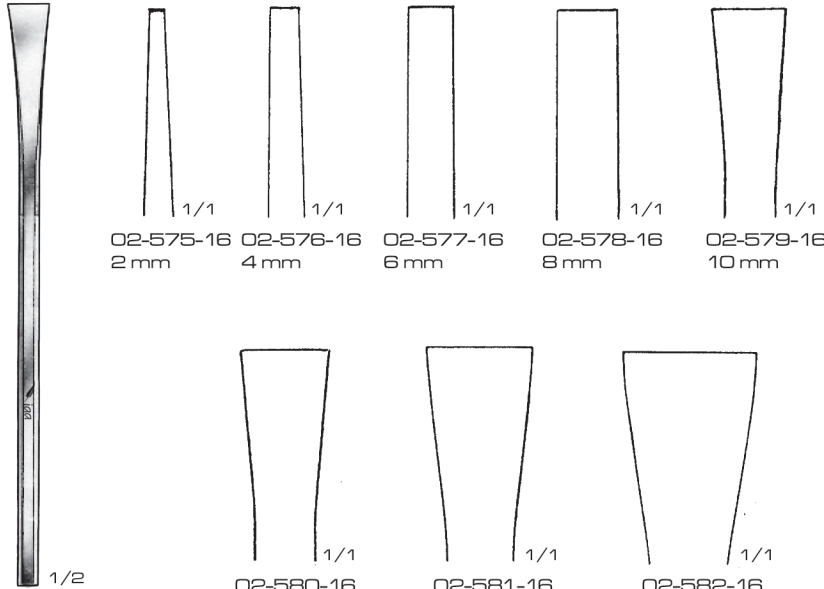

Sheehan
02-575-16 To 02-582-16
16 cm / 6 1/4"

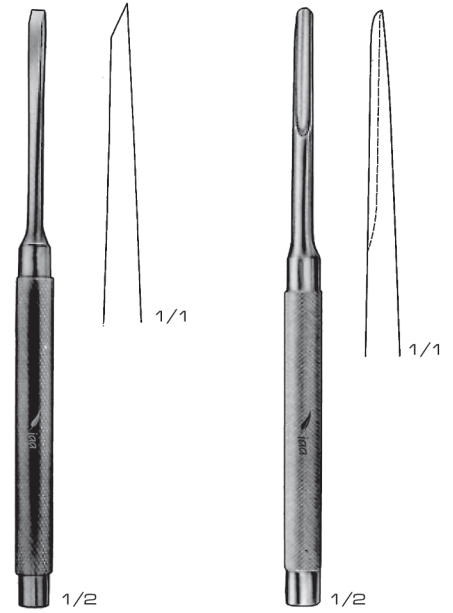

Lucas
02-583-16 4 mm
02-584-16 6 mm
16 cm / 6 1/4"

Lucas
02-585-16 3 mm
02-586-16 5 mm
16 cm / 6 1/4"

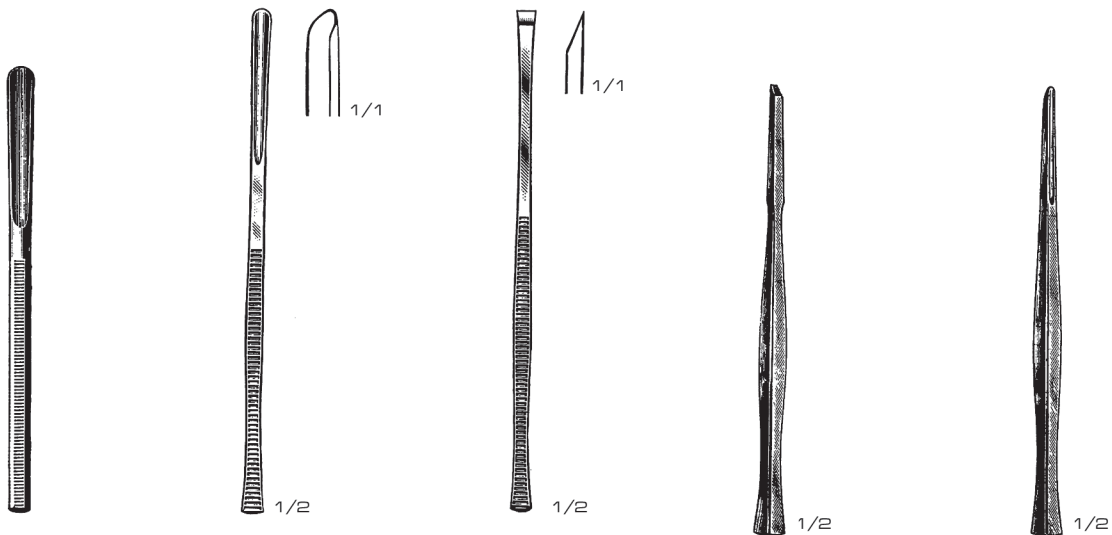

Bishop
02-587-15 2 mm
02-588-15 3 mm
02-589-15 4 mm
02-590-15 5 mm
02-591-15 6 mm
15 cm / 6"

Bishop
02-592-17 3 mm
02-593-17 4 mm
02-594-17 5 mm
17 cm / 6 3/4"

Bishop
02-595-17 3 mm
02-596-17 4 mm
02-597-17 5 mm
17 cm / 6 3/4"

02-598-13 2 mm
02-599-13 3 mm
02-600-13 4 mm
02-601-13 5 mm
02-602-13 6 mm
02-603-13 7 mm
13 cm / 5 1/8"

02-604-13 2 mm
02-605-13 3 mm
02-606-13 4 mm
02-607-13 5 mm
02-608-13 6 mm
02-609-13 7 mm
02-610-13 8 mm
02-611-13 9 mm
13 cm / 5 1/8"

BONE CHISSELS, GOUGES AND OSTEOTOMES

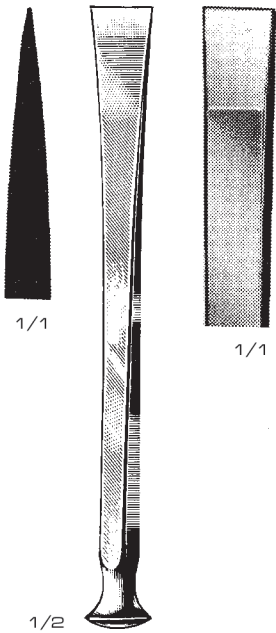

U. S. Army
02-612-16 6 mm
02-613-16 12 mm
02-614-16 18 mm
16 cm / 6 1/4"

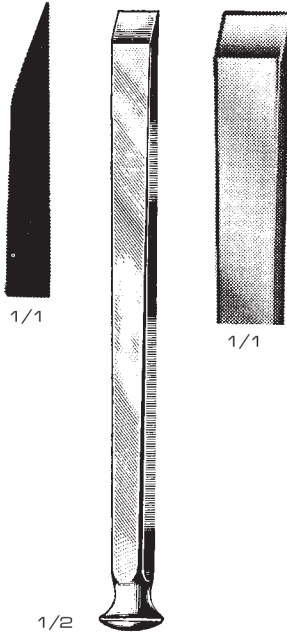

U. S. Army
02-615-16 6 mm
02-616-16 12 mm
02-617-16 18 mm
16 cm / 6 1/4"

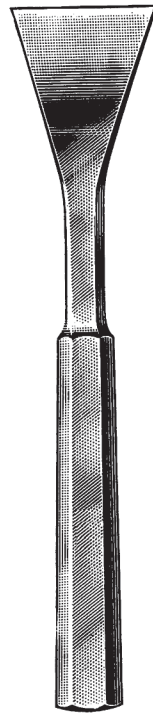

Murphy
02-618-16 30 mm
02-619-16 40 mm
16 cm / 6 1/4"

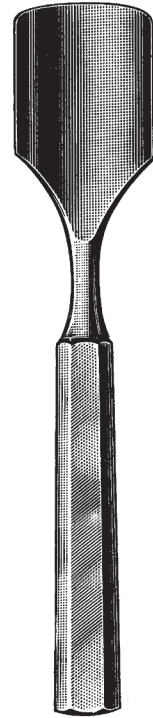

Murphy
02-620-16 30 mm
02-621-16 40 mm
16 cm / 6 1/4"

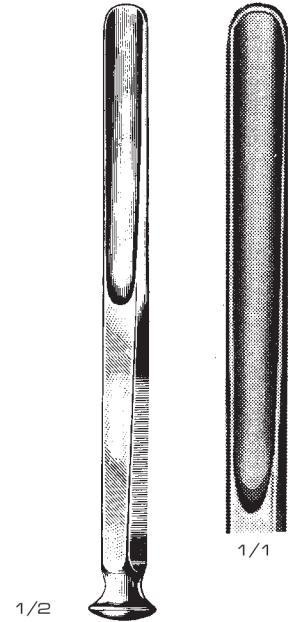

U. S. Army
02-622-16 6 mm
02-623-16 12 mm
02-624-16 18 mm
16 cm / 6 1/4"

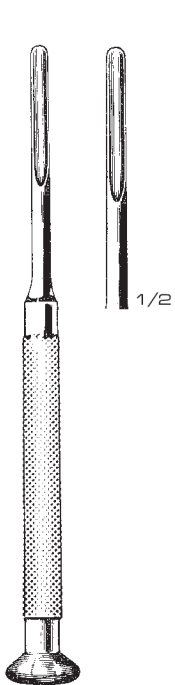

Lambotte
02-625-16 3 mm
02-626-16 4 mm
02-627-16 5 mm
02-628-16 6 mm
02-629-16 8 mm
16 cm / 6 1/4"



Alexander
02-630-18 To 02-635-18
18 cm / 7"

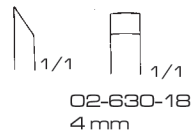

02-630-18
4 mm

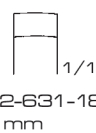

02-631-18
6 mm

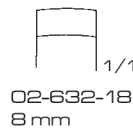

02-632-18
8 mm

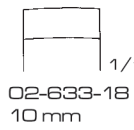

02-633-18
10 mm

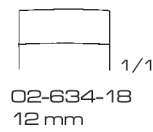

02-634-18
12 mm

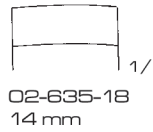

02-635-18
14 mm



02-636-18
4 mm

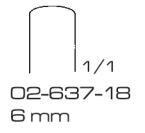

02-637-18
6 mm

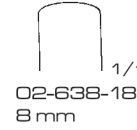

02-638-18
8 mm



02-639-18
10 mm



02-640-18
12 mm



02-641-18
14 mm



Alexander
02-636-18 To 02-641-18
18 cm / 7"

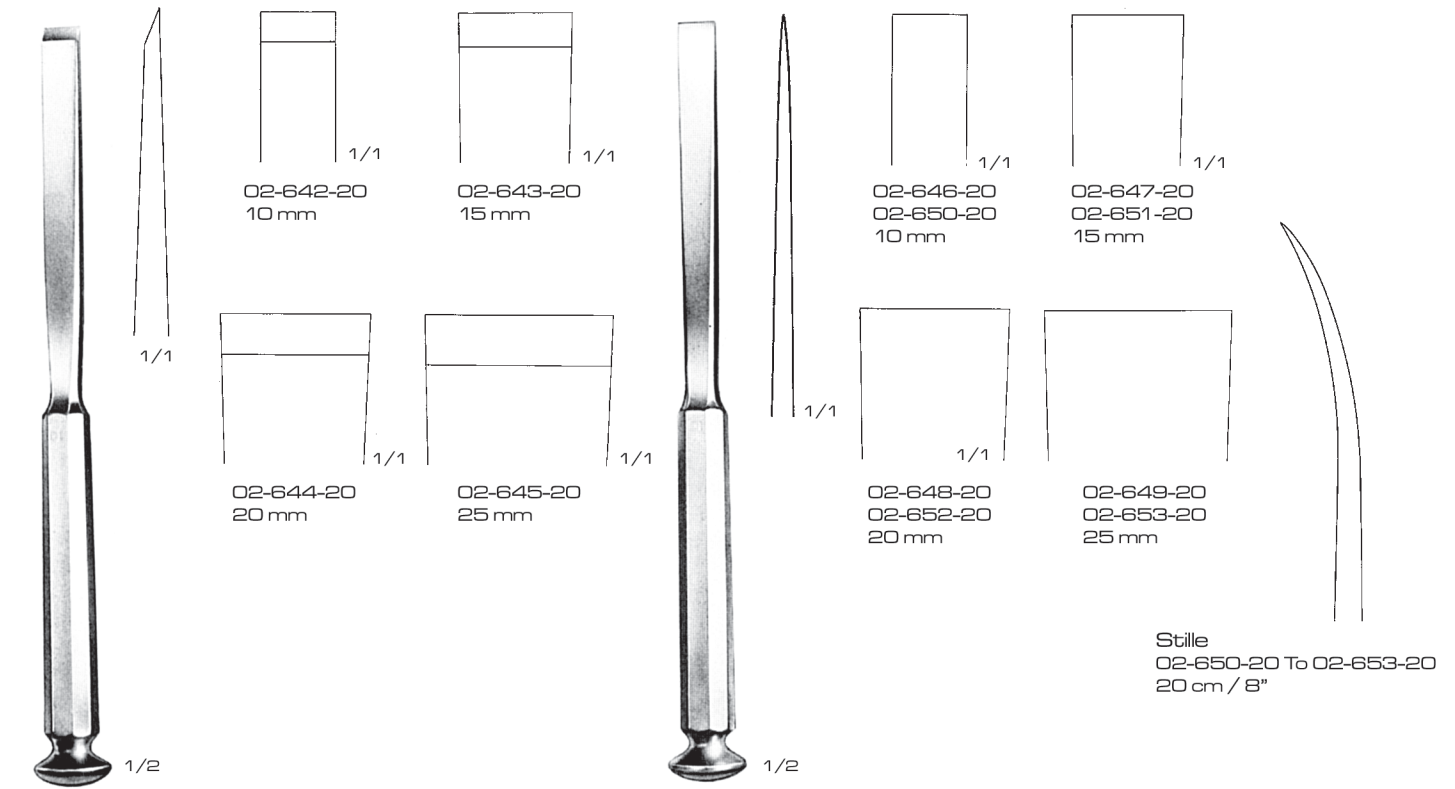

Stille
02-642-20 To 02-645-20
20 cm / 8"

Stille
02-646-20 To 02-649-20
20 cm / 8"

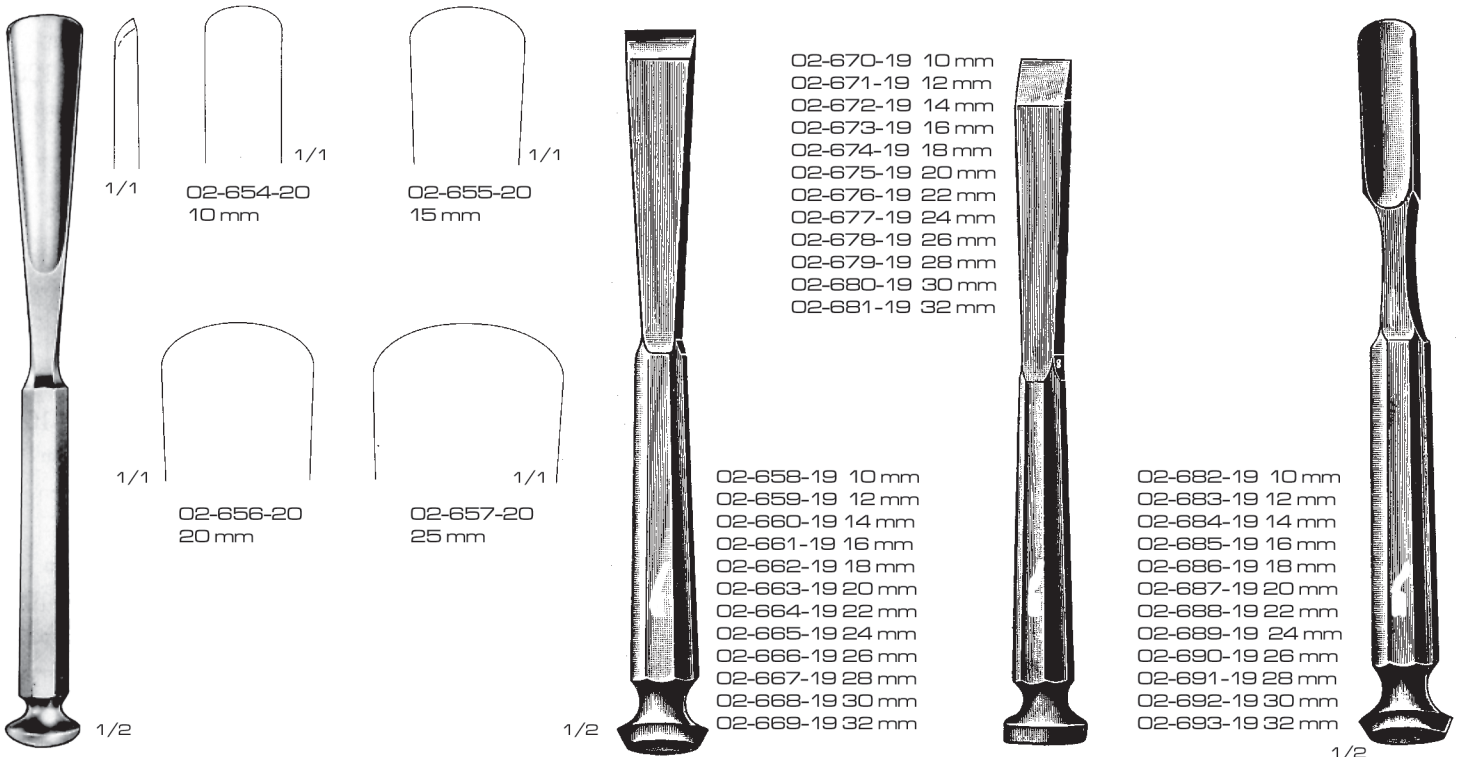

Stille
02-654-20 To 02-657-20
20 cm / 8"

McEwen
02-658-19 To
02-669-19
19 cm / 7½"

McEwen
02-670-19 To
02-681-19
19 cm / 7½"

McEwen
02-682-19 To
02-693-19
19 cm / 7½"

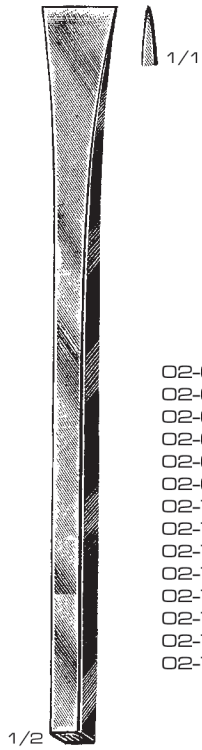

- | | | |
|-----------|-------|-----------|
| 02-694-20 | 6 mm | 02-708-19 |
| 02-695-20 | 8 mm | 02-709-19 |
| 02-696-20 | 10 mm | 02-710-19 |
| 02-697-20 | 12 mm | 02-711-19 |
| 02-698-20 | 14 mm | 02-712-19 |
| 02-699-20 | 16 mm | 02-713-19 |
| 02-700-20 | 18 mm | 02-714-19 |
| 02-701-20 | 20 mm | 02-715-19 |
| 02-702-20 | 22 mm | 02-716-19 |
| 02-703-20 | 24 mm | 02-717-19 |
| 02-704-20 | 26 mm | 02-718-19 |
| 02-705-20 | 28 mm | 02-719-19 |
| 02-706-20 | 30 mm | 02-720-19 |
| 02-707-20 | 32 mm | 02-721-19 |

Bergmann
02-694-20 To
02-707-20
20 cm / 8"

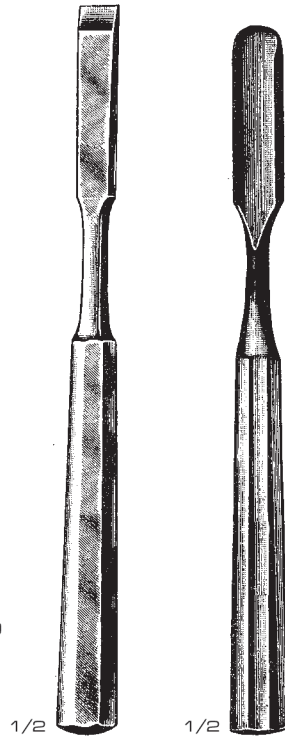

Brun's
02-708-19 To
02-721-019
19 cm / 7½"

Brun's
02-722-19 To
02-735-19
19 cm / 7½"

- | | | |
|-----------|-------|-----------|
| 02-722-19 | 6 mm | 02-736-19 |
| 02-723-19 | 8 mm | 02-737-19 |
| 02-724-19 | 10 mm | 02-738-19 |
| 02-725-19 | 12 mm | 02-739-19 |
| 02-726-19 | 14 mm | 02-740-19 |
| 02-727-19 | 16 mm | 02-741-19 |
| 02-728-19 | 18 mm | 02-742-19 |
| 02-729-19 | 20 mm | 02-743-19 |
| 02-730-19 | 22 mm | 02-744-19 |
| 02-731-19 | 24 mm | 02-745-19 |
| 02-732-19 | 26 mm | 02-746-19 |
| 02-733-19 | 28 mm | 02-747-19 |
| 02-734-19 | 30 mm | 02-748-19 |
| 02-735-19 | 32 mm | 02-749-19 |



Brun's
02-736-19 To
02-749-19
19 cm / 7½"

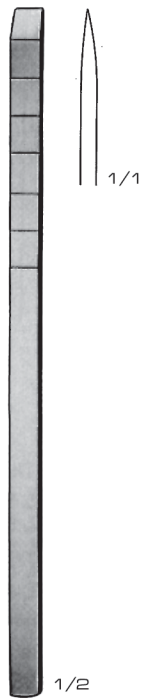

Cottle
02-750-18 4 mm
02-751-18 6 mm
02-752-18 8 mm
02-753-18 10 mm
02-754-18 12 mm
18 cm / 7"

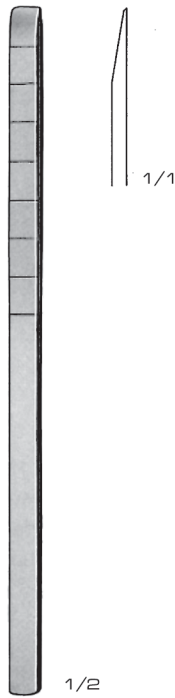

Cottle
02-755-18 4 mm
02-756-18 7 mm
02-757-18 9 mm
02-758-18 12 mm
18 cm / 7"

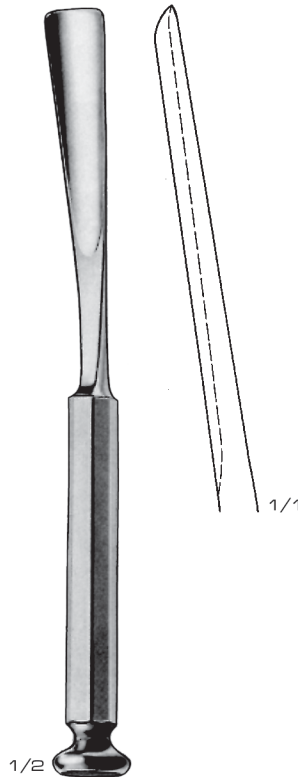

Walter
02-759-20 10 mm
02-760-20 15 mm
20 cm / 8"



02-761-16 6 mm
02-762-16 8 mm
02-763-16 10 mm
02-764-16 12 mm
16 cm / 6¼"



02-765-16 6 mm
02-766-16 8 mm
02-767-16 10 mm
02-768-16 12 mm
16 cm / 6¼"

1/1
02-769-20
02-776-20
6 mm

1/1
02-770-20
02-777-20
9 mm

1/1
02-771-20
02-778-20
13 mm

1/1
02-772-20
02-779-20
16 mm

1/1
02-773-20
02-780-20
19 mm

1/1
02-774-20
02-781-20
25 mm

1/1
02-775-20
02-782-20
32 mm

1/1
02-783-245
3 mm

1/1
02-784-245
4 mm

1/1
02-785-245
6 mm

1/1
02-786-245
8 mm

1/1
02-787-245
10 mm

1/1
02-788-245
12 mm

1/1
02-789-245
15 mm

Smith-Petersen
02-769-20 To 02-775-20
20 cm / 8"

Smith-Petersen
02-776-20 To 02-782-20
20 cm / 8"

Mini-Lambotte
02-783-245 To 02-789-245
24.5 cm / 9³/₄"

1/1
02-790-20
02-797-20
6 mm

1/1
02-791-20
02-798-20
9 mm

1/1
02-792-20
02-799-20
13 mm

1/1
02-793-20
02-800-20
13 mm

1/1
02-794-20
02-801-20
13 mm

1/1
02-795-20
02-802-20
13 mm

1/1
02-796-20
02-803-20
13 mm

1/1
02-804-125
3 mm

1/1
02-805-125
4 mm

1/1
02-806-125
6 mm

1/1
02-807-125
8 mm

1/1
02-808-125
10 mm

1/1
02-809-125
12 mm

1/1
02-810-125
15 mm

Smith-Petersen
02-790-20 To 02-796-20
20 cm / 8"

Smith-Petersen
02-797-20 To 02-803-20
20 cm / 8"

Mini-Lambotte
02-804-125 To 02-810-125
12.5 cm / 5"



1/2

Lexer
02-832-22 To 02-837-22
22 cm / 8 3/4"

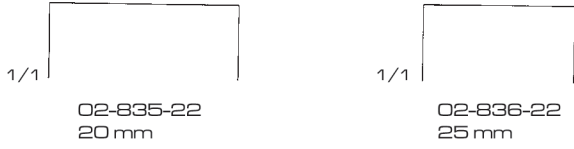
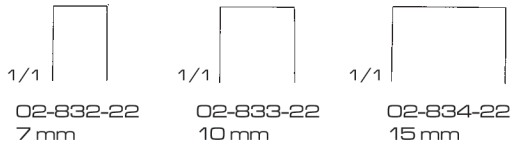

1/2

Lexer
02-838-22 To 02-843-22
22 cm / 8 3/4"

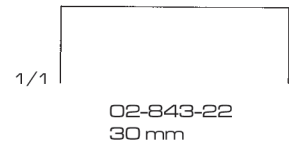
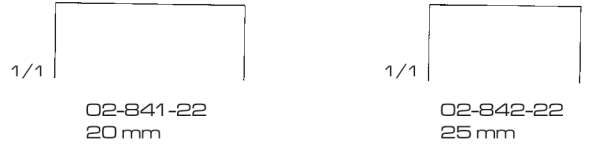
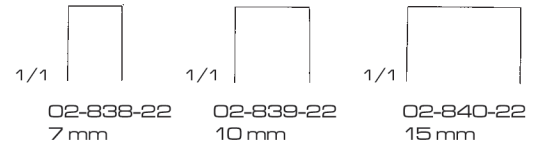

1/1



1/2

Mini-Lexer
02-844-18 To 02-848-18
18 cm / 7"

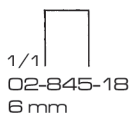

1/2



Lexer
02-650-25 To 02-655-25
25 cm / 10"

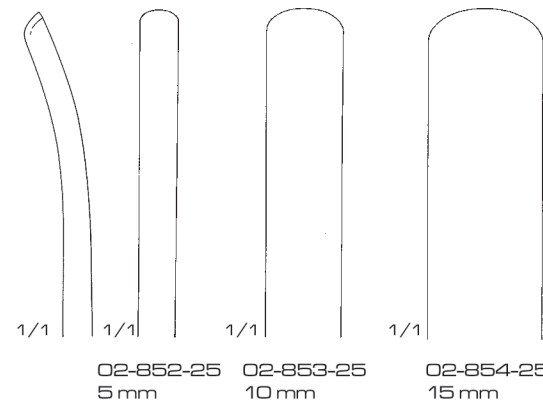
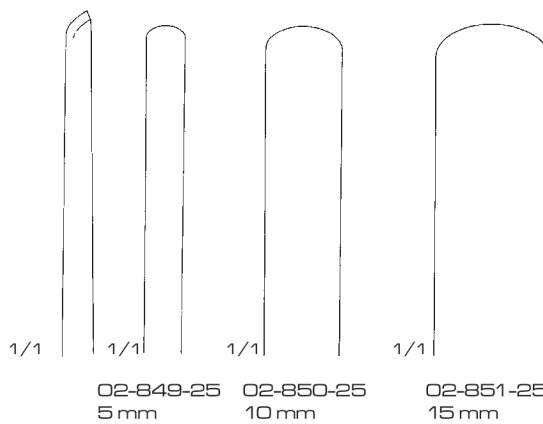

1/2

Mini-Lexer
02-855-18 To 02-859-18
18 cm / 7"

BONE CHISSELS, GOUGES AND OSTEOTOMES

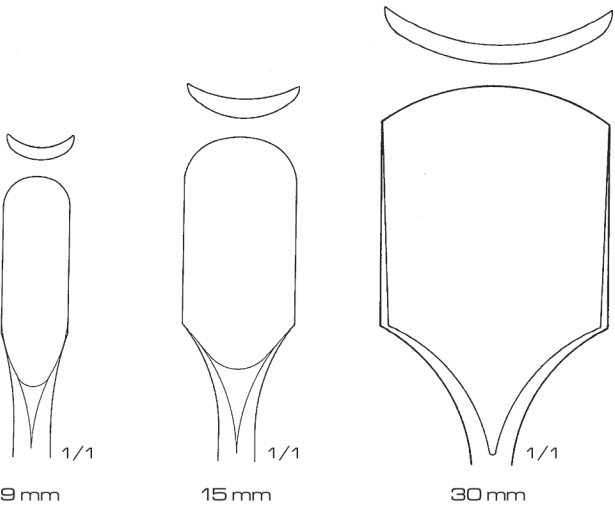
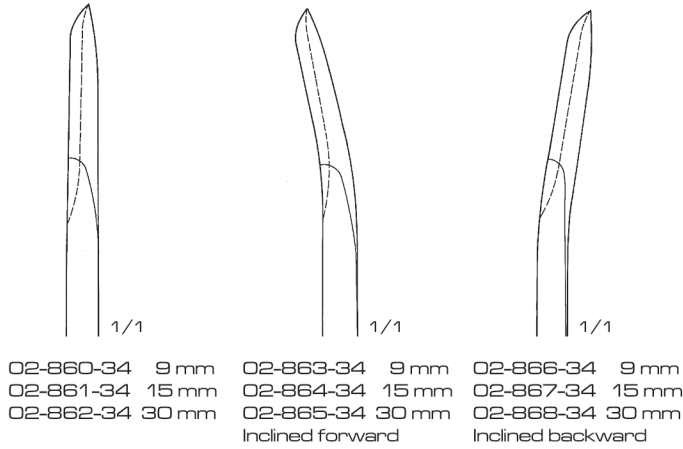

Wagner
02-860-34 To 02-868-34
34 cm / 13 1/2"
Thin Concave osteotome

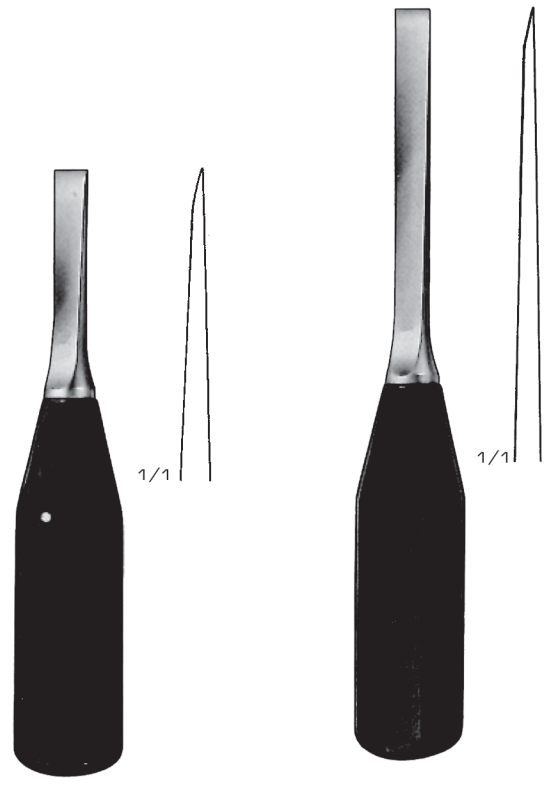

02-869-16 10 mm
02-870-16 15 mm
16 cm / 6 1/4"

02-871-20 10 mm
02-872-20 15 mm
02-873-20 20 mm
20 cm / 8"



02-874-24 20 mm
24 cm / 9 3/4"



Zielke
02-875-23 5.5 mm
02-876-23 9 mm
23 cm / 9"

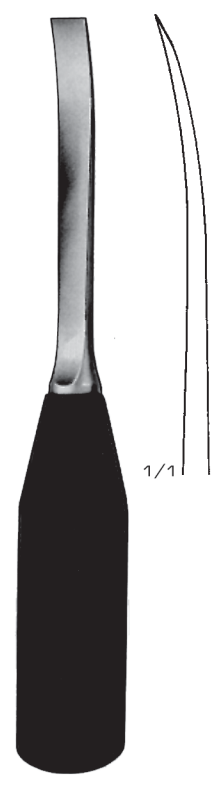

02-877-20 10 mm
02-878-20 15 mm
02-879-20 20 mm
20 cm / 8"

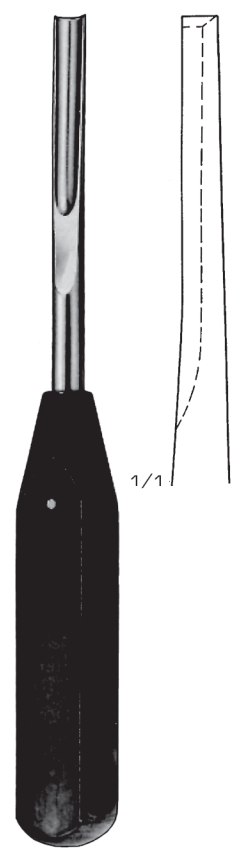

02-880-22 9 mm
22 cm / 8 3/4"





1/1 
02-881-29
3 x 8 mm

1/1 
02-882-29
4 x 10 mm

1/1 
02-883-29
5 x 15 mm

1/1 
02-884-29
6 x 20 mm

1/2

Sypert
02-881-29 To 02-884-29
29 cm / 11 1/2"



1/2

Haase
02-885-10
10 cm / 4"



1/2

Passow
02-886-12 & 02-887-12
12 cm / 4 3/4"





1/1 
02-886-12
2.5 mm

1/1 
02-887-12
3.5 mm



1/2

1/1 
02-888-16
Ø 3 mm

1/1 
02-889-16
Ø 5 mm

1/1 
02-890-16
Ø 7 mm

1/1 
02-891-16
Ø 9 mm

02-888-16 To 02-891-16
16 cm / 6 1/2"



1/2

Caspar
02-892-20 To 02-894-20
20 cm / 8"

1/1 
02-892-20
Ø 3 mm

1/1 
02-893-20
Ø 5 mm

1/1 
02-894-20
Ø 8 mm



1/2

02-895-20 To 02-897-20
20 cm / 8"

1/1 
02-895-20
Ø 12 mm

1/1 
02-896-20
Ø 14 mm

1/1 
02-897-20
Ø 16 mm



1/2

02-898-15 To 02-904-15
15 cm / 6"

1/1 
02-898-15
Ø 2 mm

1/1 
02-900-15
Ø 4 mm

1/1 
02-902-15
Ø 6 mm

1/1 
02-904-15
Ø 10 mm

1/1 
02-899-15
Ø 3 mm

1/1 
02-901-15
Ø 5 mm

1/1 
02-903-15
Ø 8 mm

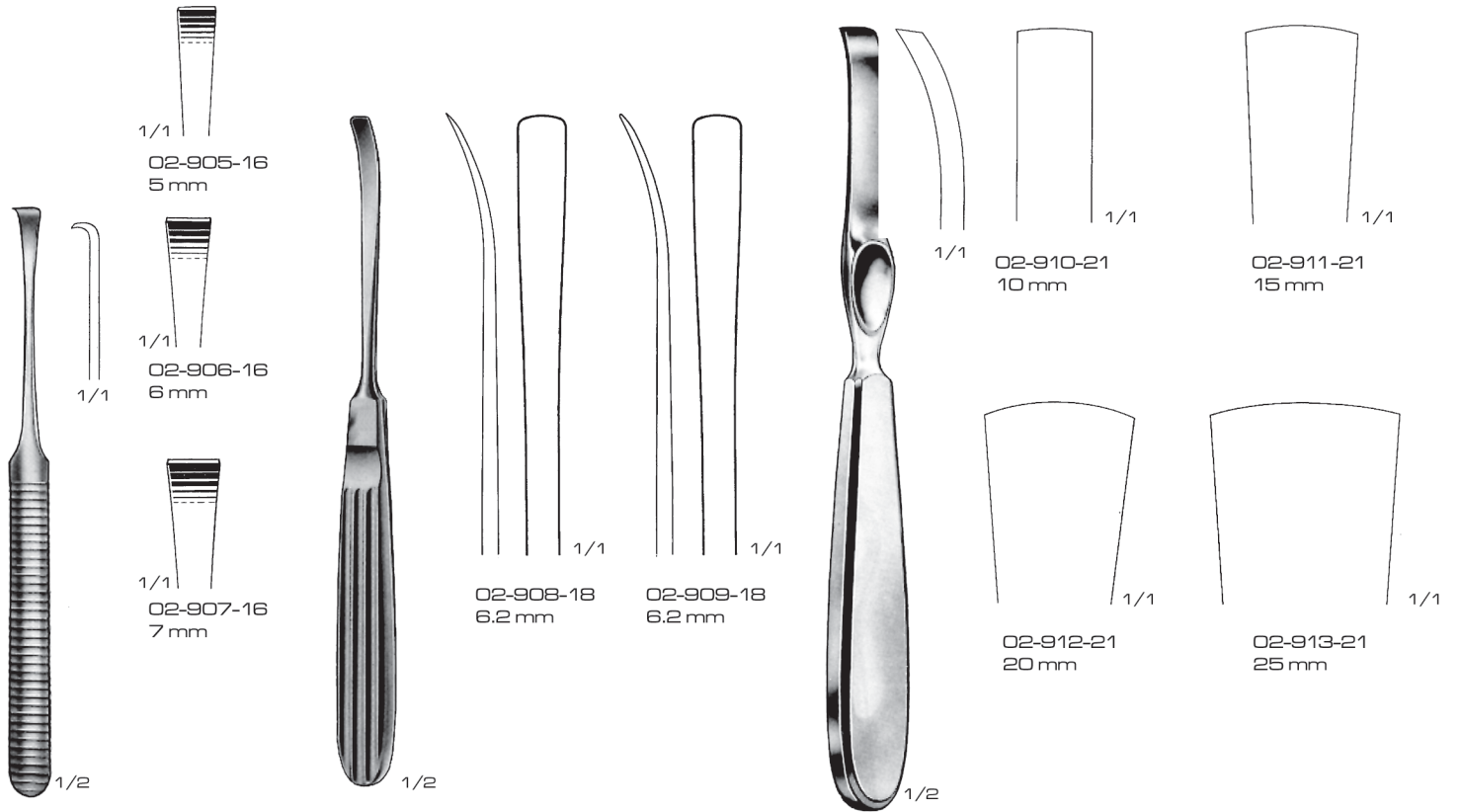

02-905-16 To 02-907-16
16 cm / 6 1/4"

Caspar
02-908-18 & 02-909-18
18 cm / 7"

Lambotte
02-910-21 To 02-913-21
21 cm / 8 1/4"

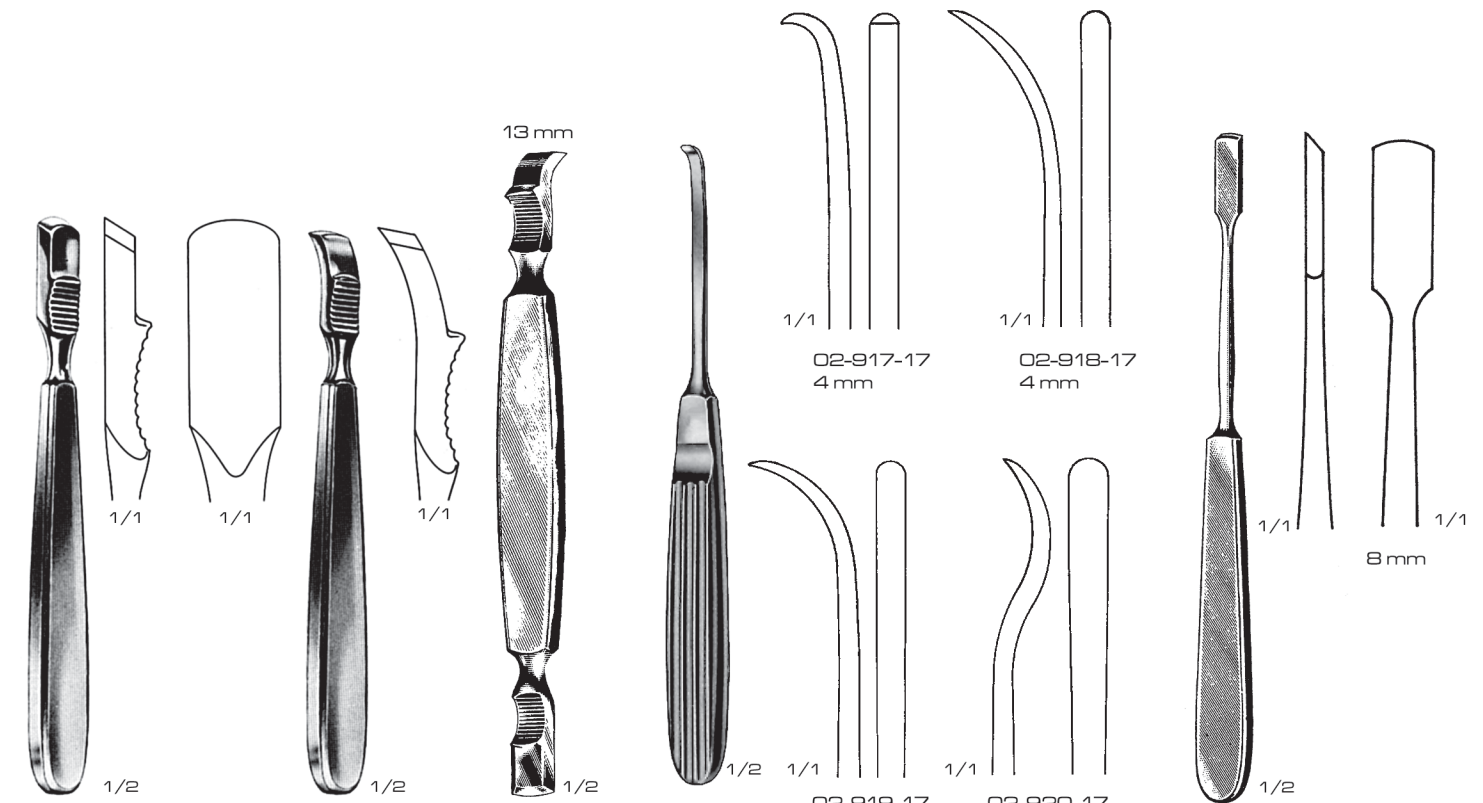

Farabeuf
02-914-15
15 cm / 6"

Farabeuf
02-915-15
15 cm / 6"

Farabeuf
02-916-19
19 cm / 7 1/2"

Muhling
02-917-17 To 02-920-17
17 cm / 6 3/4"

Olivecrona
02-921-18
18 cm / 7"

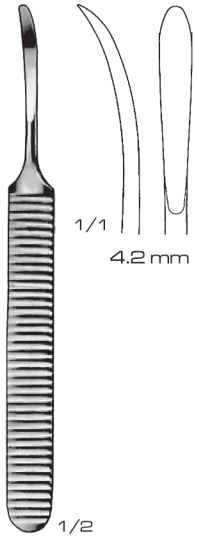

Williger
02-922-14
14 cm / 5½"

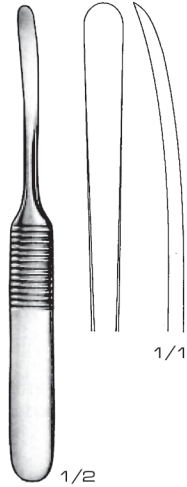

Williger
02-923-13
13 cm / 5 1/8"



Williger
02-924-16 To 02-926-16
16 cm / 6¼"

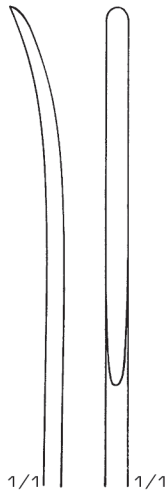

02-924-16
3 mm



02-925-16
5 mm



02-926-16
7 mm

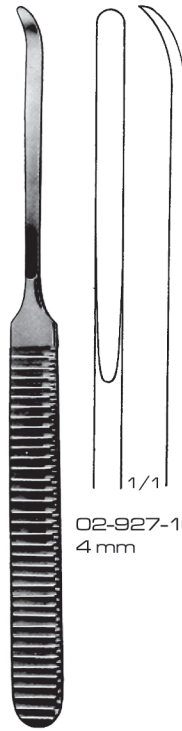

Kahre-Williger
02-927-16 & 02-928-16
16 cm / 6¼"

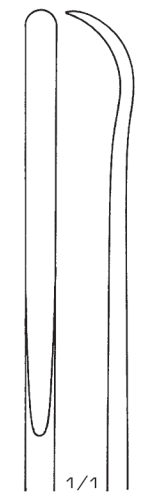

02-928-16
5 mm



Cushing
02-929-195 To 02-932-195



02-929-17
17 cm / 6¾"
4 mm

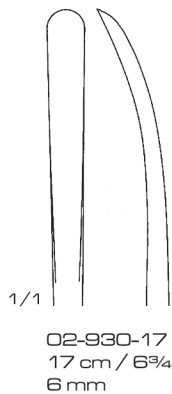

02-930-17
17 cm / 6¾"
6 mm



02-931-195
19.5 cm / 7¾"
5 mm

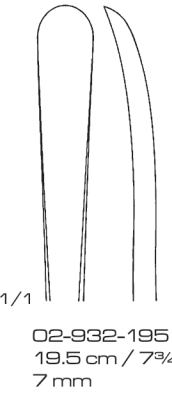

02-932-195
19.5 cm / 7¾"
7 mm



Hoen
02-933-16 To 02-935-19



02-933-16
16 cm / 6¼"
7 mm



02-934-185
18.5 cm / 7¼"
15 mm



02-935-19
19 cm / 7½"
20 mm

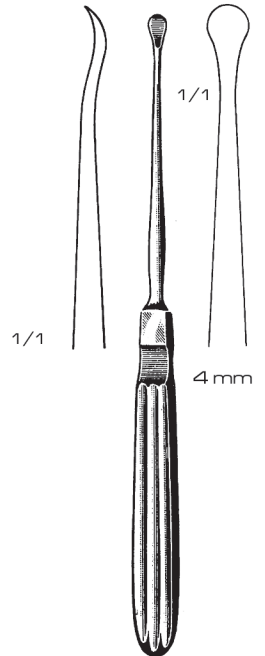

02-936-19
19 cm / 7½"

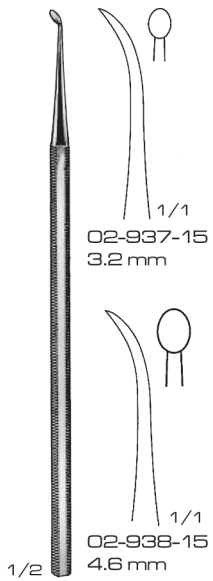

Parsch
02-937-15 &
02-938-15
15 cm / 6"

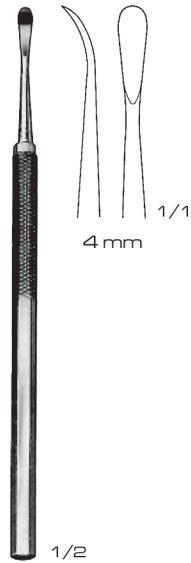

Parsch Mod. Lange
02-939-145
14.5 cm / 5 3/4"

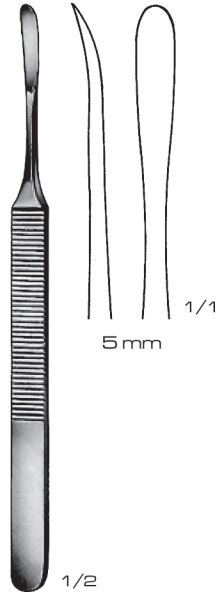

Koenig
02-940-15
15 cm / 6"

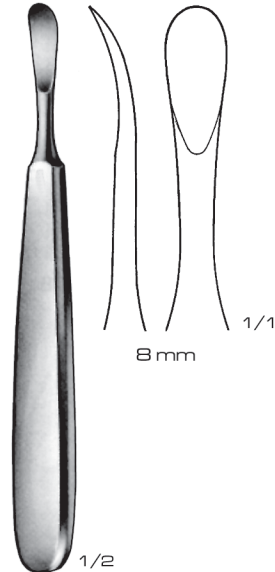

Trelat
02-941-15
15 cm / 6"

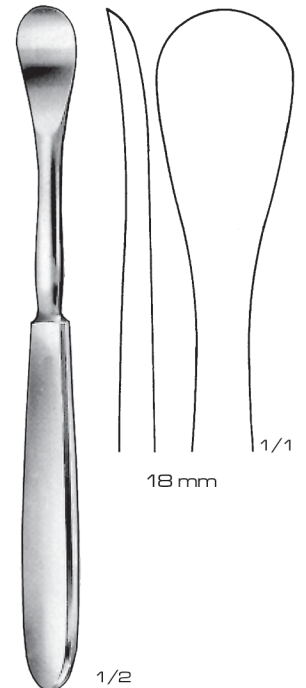

Sedillot
02-942-185
18.5 cm / 7 1/4"

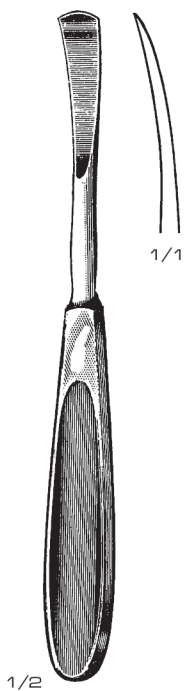

Cushing
02-943-18 & 02-944-18
18 cm / 7"

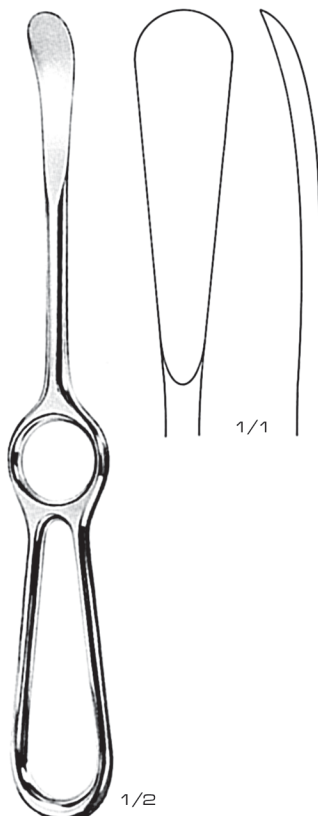

Sedillot
02-945-215
21.5 cm / 8 1/2"



Langenbeck
02-946-19 To 02-949-18

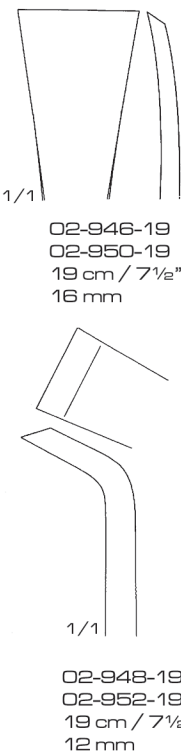

Langenbeck
02-950-19 To 02-953-18

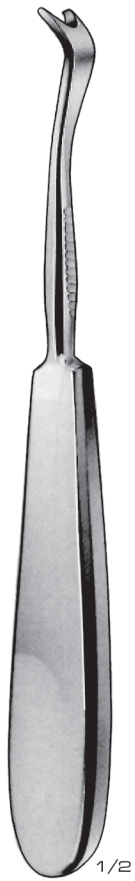

1/1

02-954-19
19 cm / 7½"
12 mm

1/2



1/1

02-955-23
23 cm / 9"
12 mm

1/1

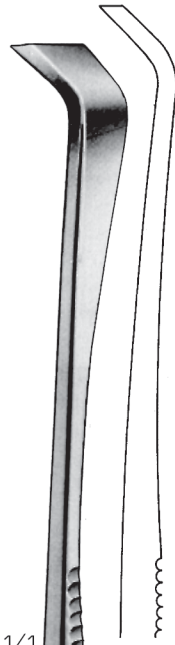

1/1

02-956-23
23 cm / 9"
13 mm

1/1



1/1

02-959-24
24 cm / 9½"
15 mm

Semb
02-954-19 To 02-959-24



1/2

02-960-185
18.5 cm / 7¼"
10 mm

1/1

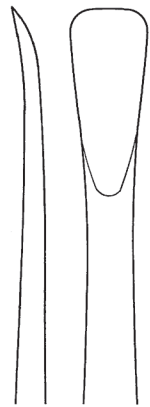

1/1

02-961-19
19 cm / 7½"
10 mm



1/2

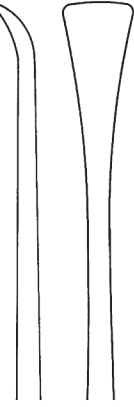

1/1

1/1

Buchs
02-962-19
19 cm / 7½"



1/2

Schneider
02-963-18
18 cm / 7"



1/1



1/1



1/2

Schneider-Sauenbruch
02-964-19
19 cm / 7½"



1/1



1/1

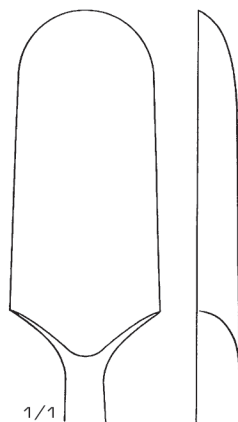
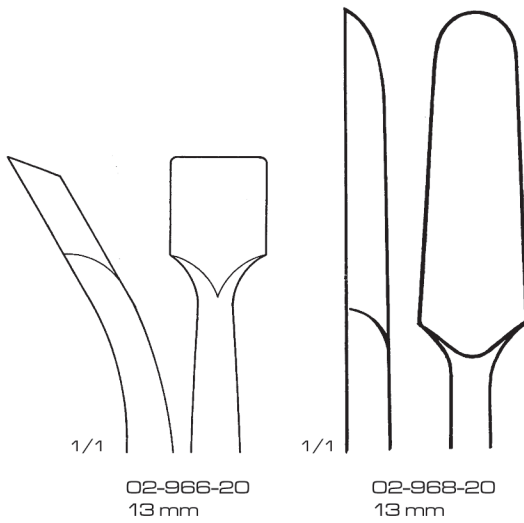
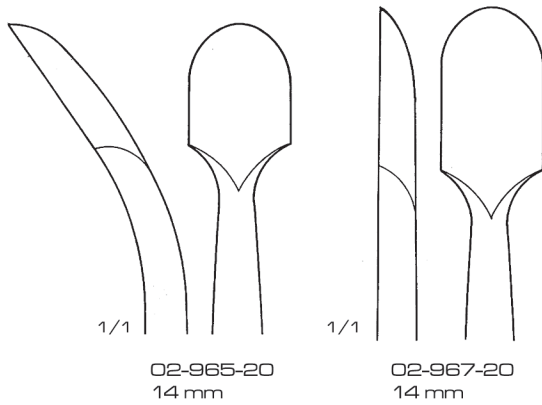

02-965-20 To 02-969-20
20 cm / 8"



Wagner
02-970-33 & 02-971-33
33 cm / 13"

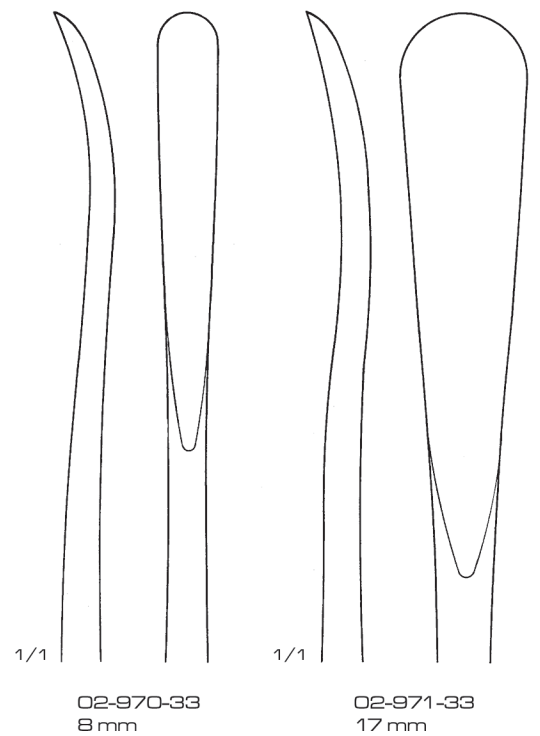



Cobb
02-972-25 To 02-975-25
25 cm / 10"

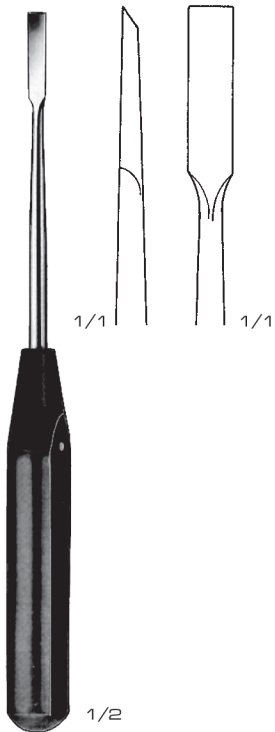
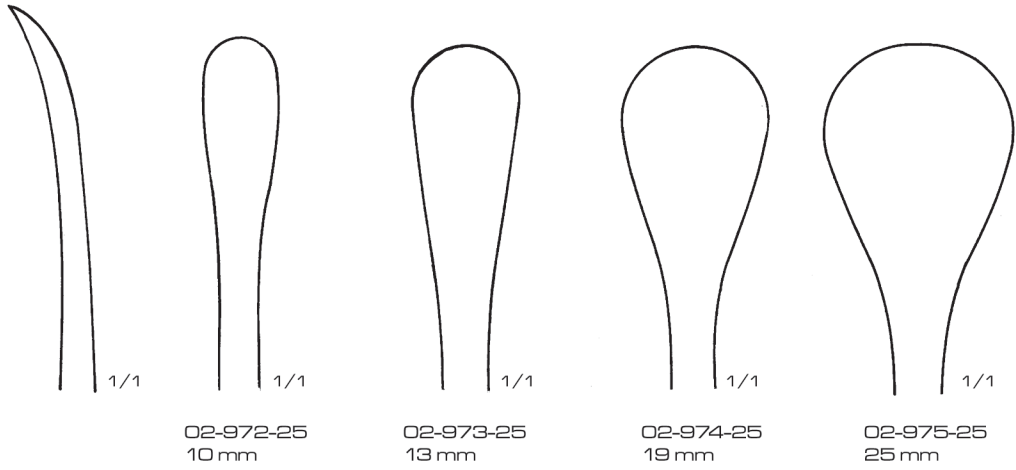

02-976-19
19 cm / 7½"

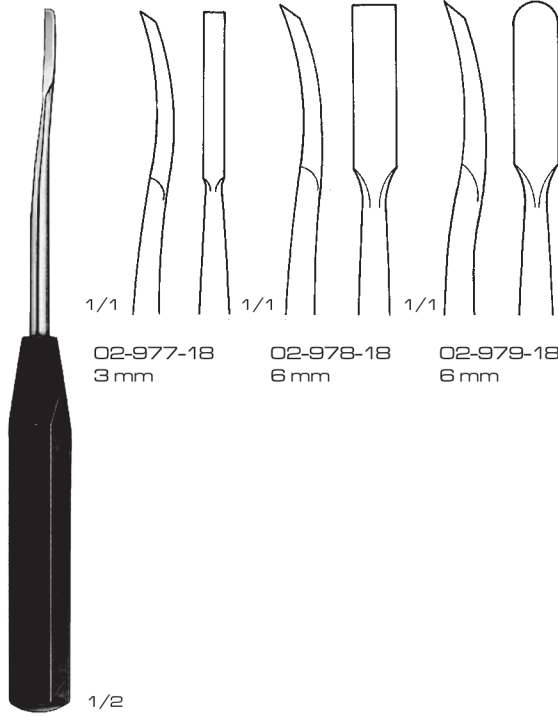

02-977-18 To 02-979-18
18 cm / 7¼"

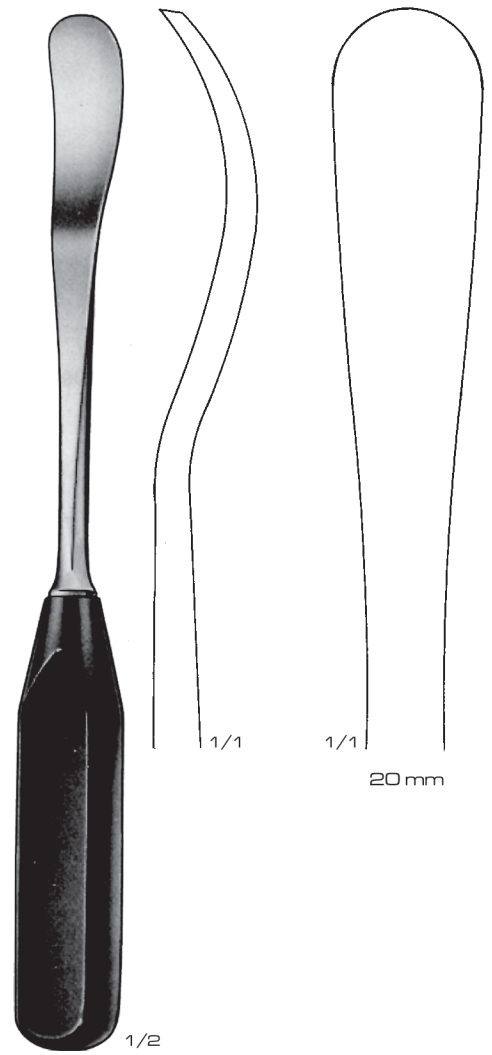

02-980-275
27.5 cm / 10¾"

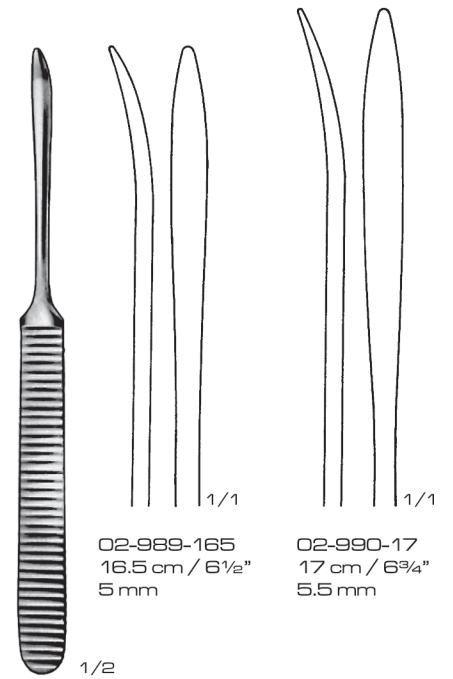
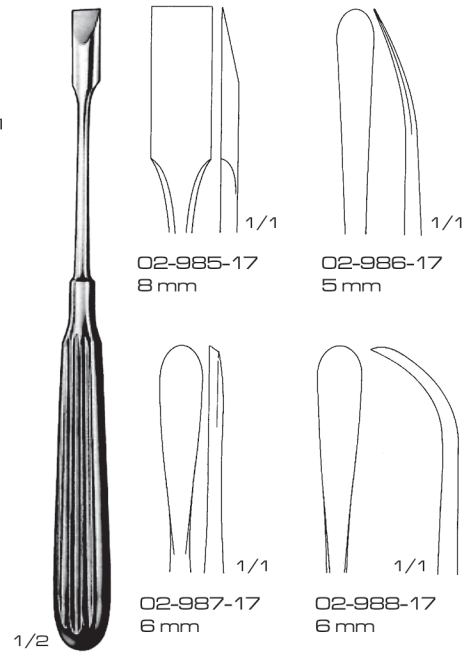
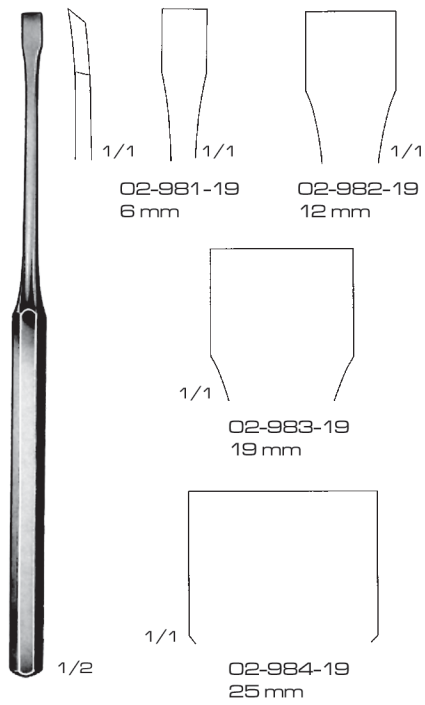

Key
02-981-19 To 02-984-19
19 cm / 7 1/2"

Adson
02-985-17 To 02-988-17
17 cm / 6 3/4"

Williger
02-989-165 & 02-990-17

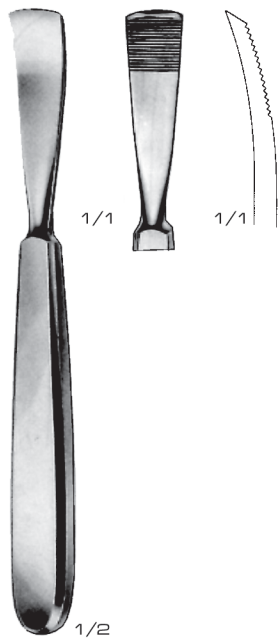

Jansen
02-991-165
16.5 cm / 6 1/2"

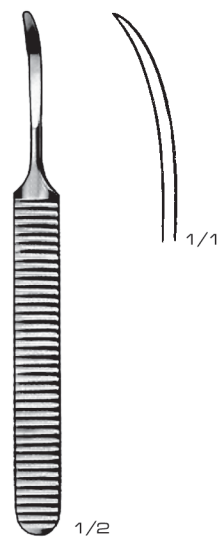

Williger
02-992-14
14 cm / 5 1/2"

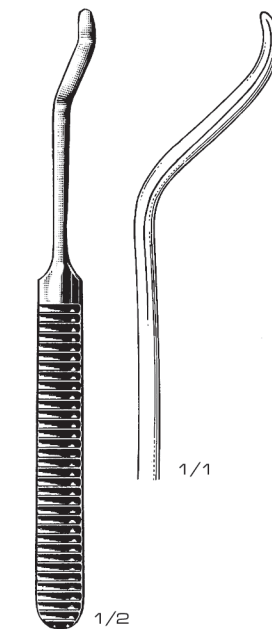

02-993-16
16 cm / 6 1/4"

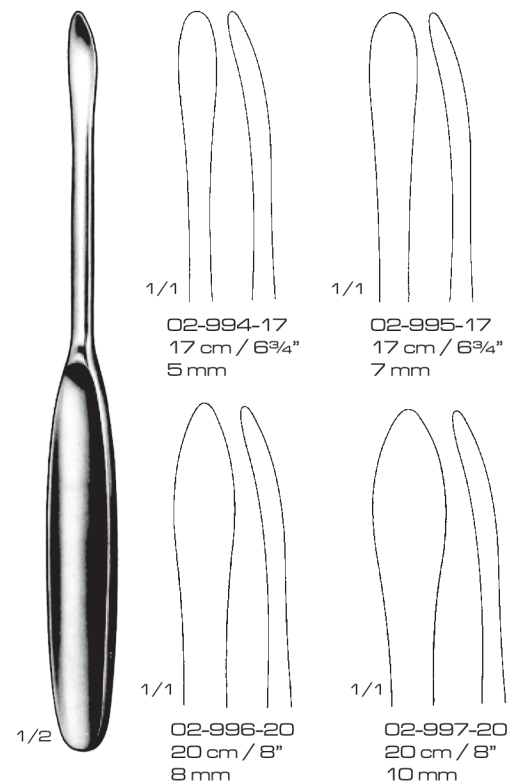

Obwegesser
02-994-17 To 02-997-20

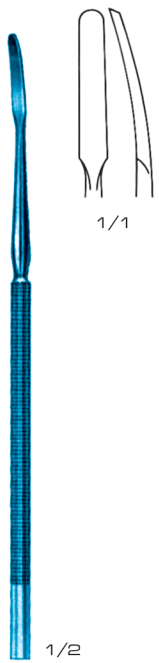

Vickers
02-998-17
17 cm / 6¾"

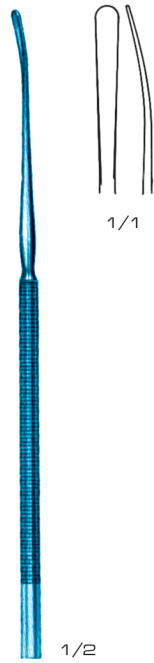

Vickers
02-999-17
17 cm / 6¾"



02-1000-17
17 cm / 6¾"



02-1001-17
17 cm / 6¾"



McDonald
02-1002-19
19 cm / 7½"

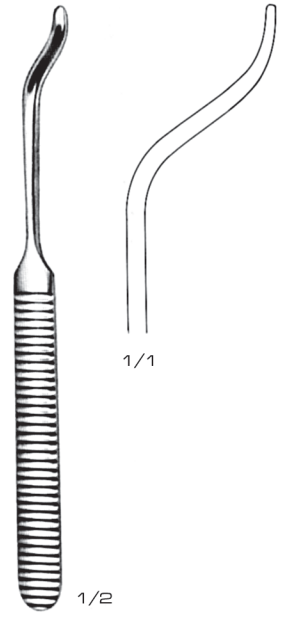

02-1003-16
16 cm / 6¼"

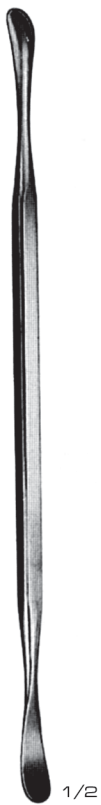

Alderdyce
02-1004-21
21 cm / 8¼"

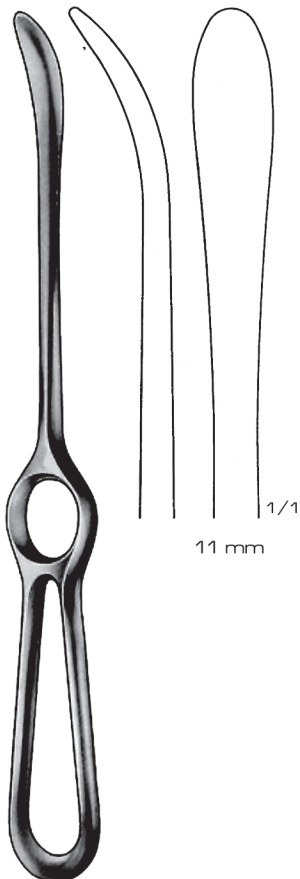

Langenbeck
02-1005-23
23 cm / 9"

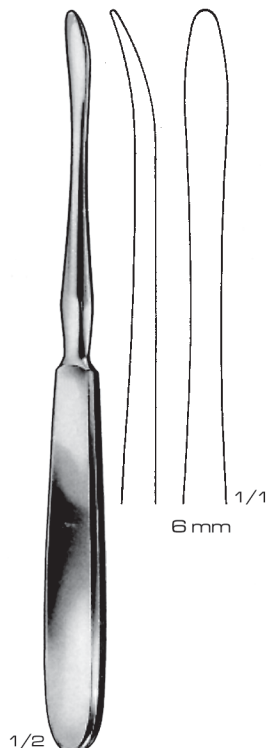

Quervain
02-1006-195
19.5 cm / 7¾"

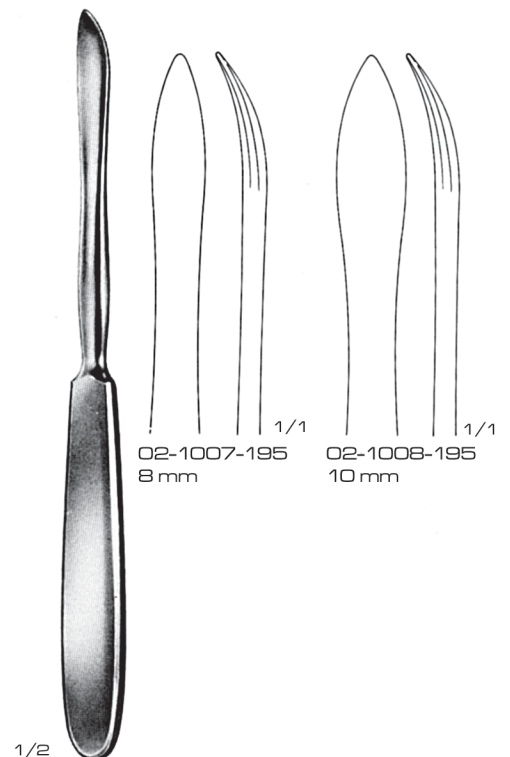

Langenbeck
02-1007-195 & 02-1008-195
19.5 cm / 7¾"

BONE LEVERS



1/3

Blount
02-1009-26
26 cm / 10 1/4"

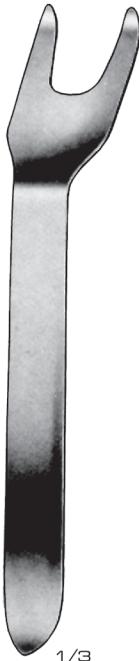

1/3

Blount
02-1010-26
26 cm / 10 1/4"

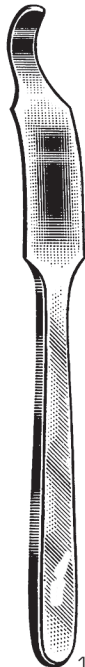

1/2

Lange-Baby
02-1011-17
17 cm / 6 3/4"



1/3

Taylor
02-1012-165 & 02-1013-165
16.5 cm / 6 1/2"

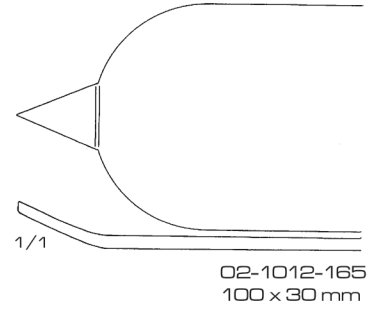

02-1012-165
100 x 30 mm

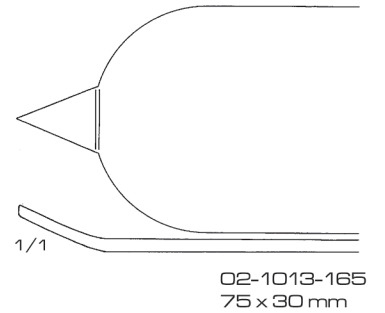

02-1013-165
75 x 30 mm

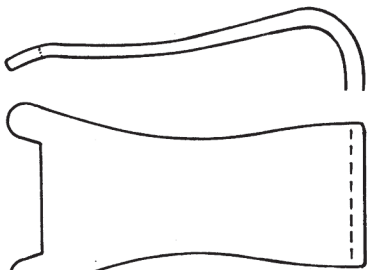

1/1

02-1014-24
26 x 43 mm

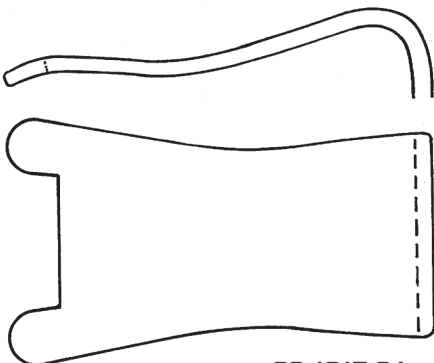

1/1

02-1015-24
33 x 54 mm

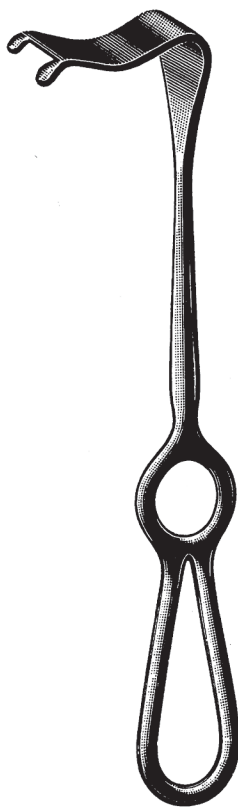

Blount
02-1014-24 & 02-1015-24
24 cm / 9 1/2"



1/2

Lange
02-1016-22
22 cm / 8 3/4"

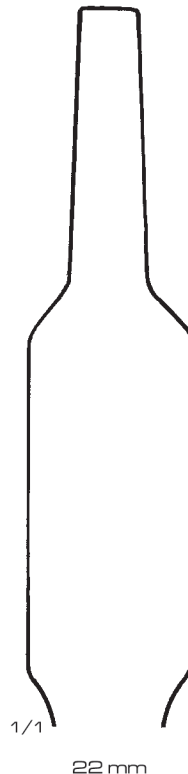

1/1

22 mm

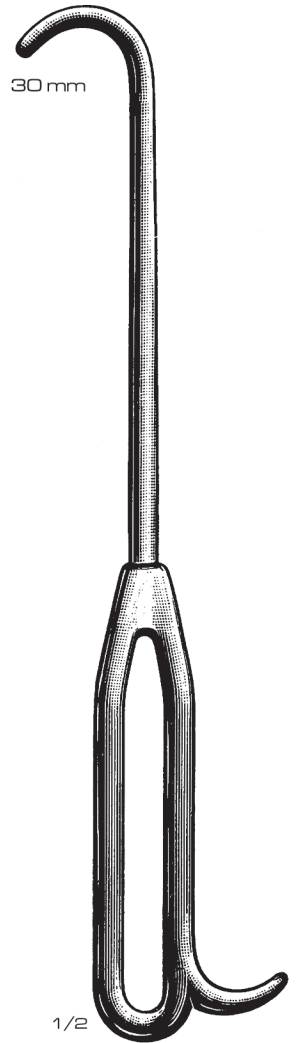

30 mm

1/2

Lambotte
02-1017-27
27 cm / 10 1/2"

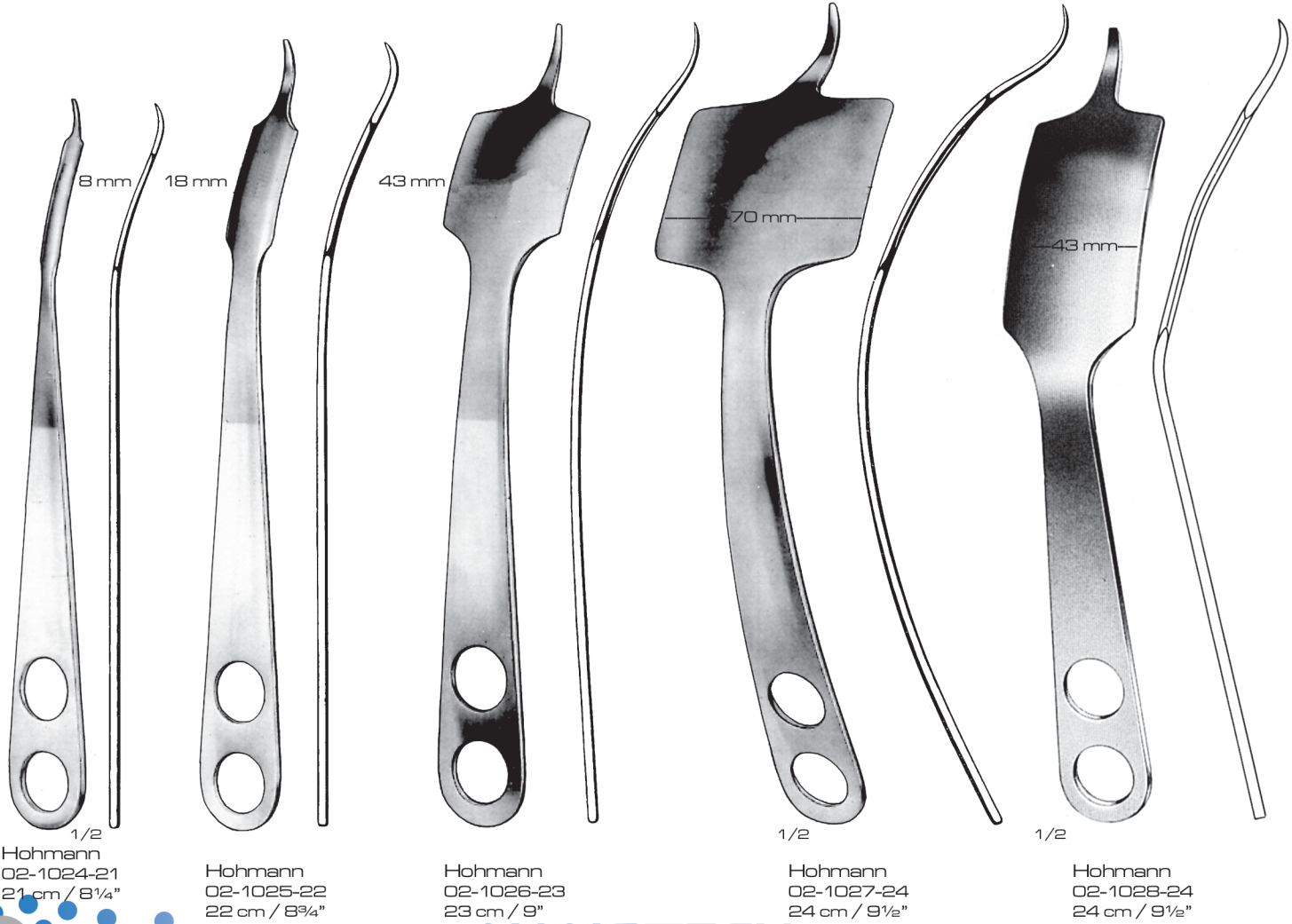
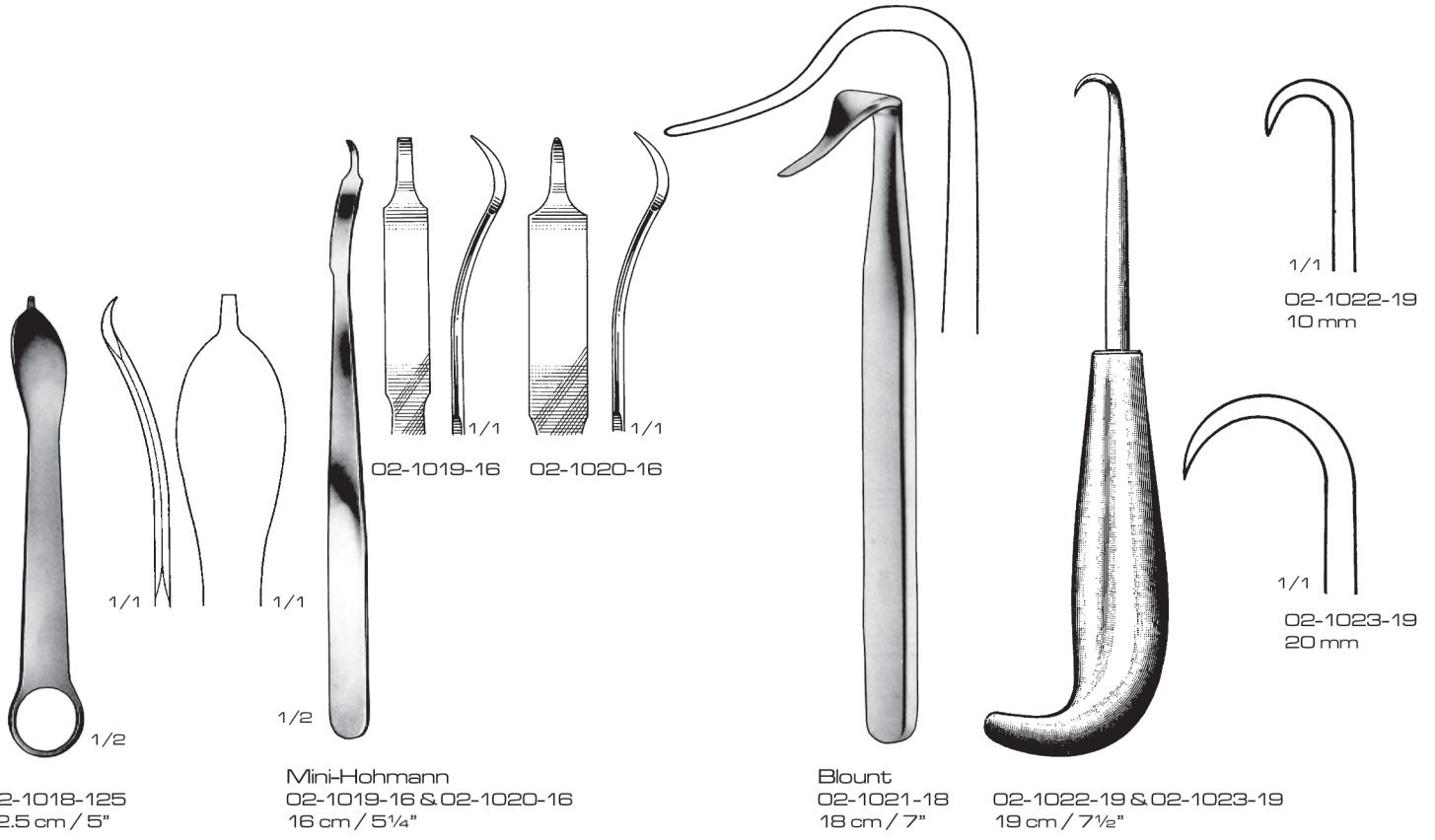

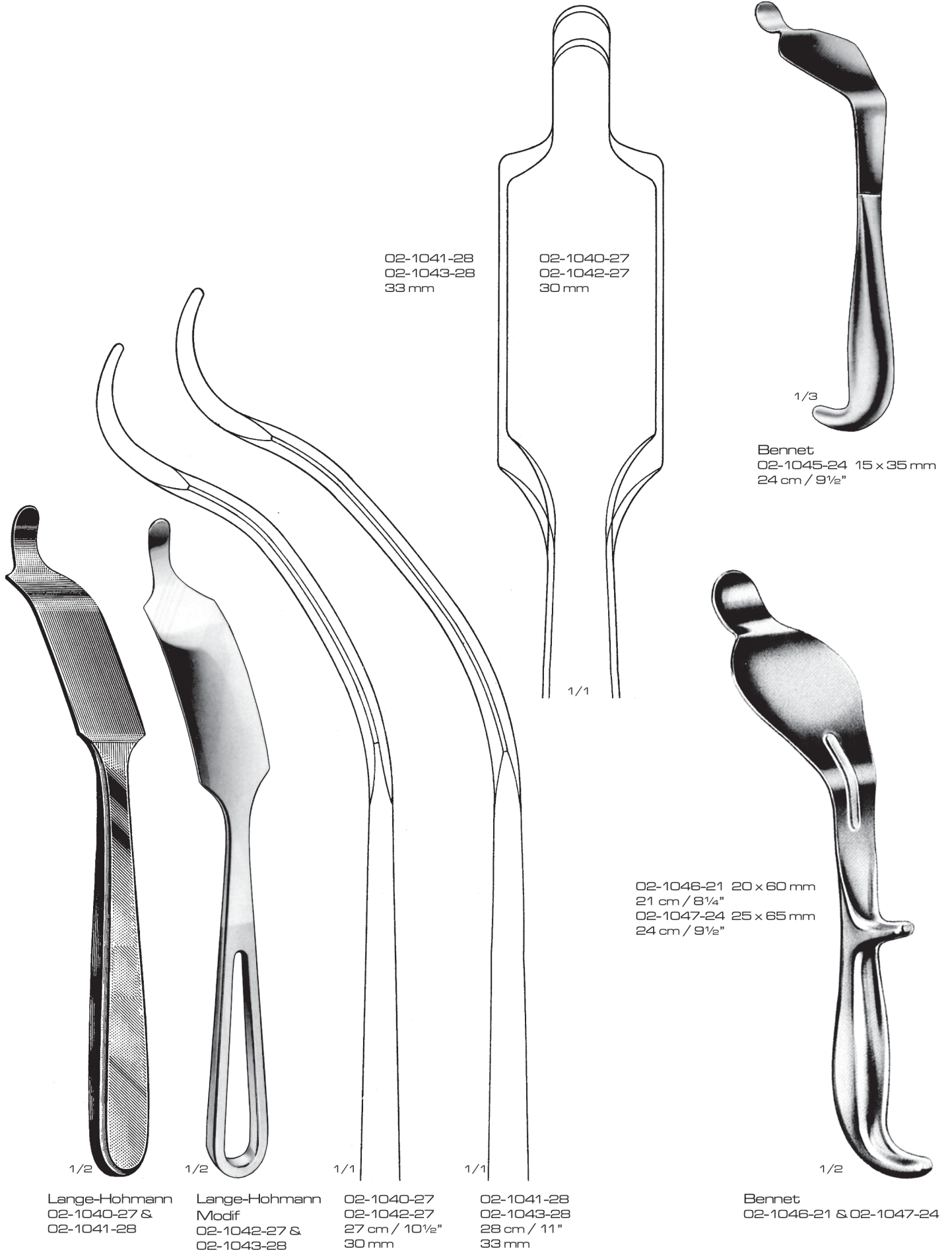

BONE LEVERS

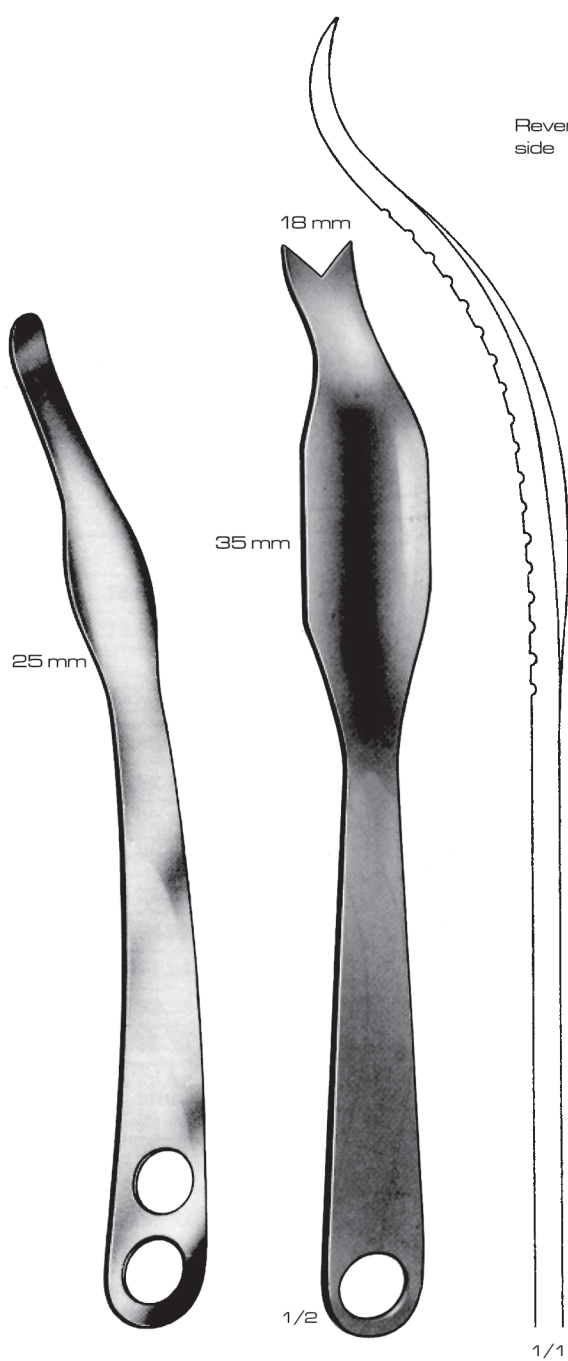

02-1050-27
27 cm / 10½"

Schumacher
02-1051-29
29 cm / 11½"

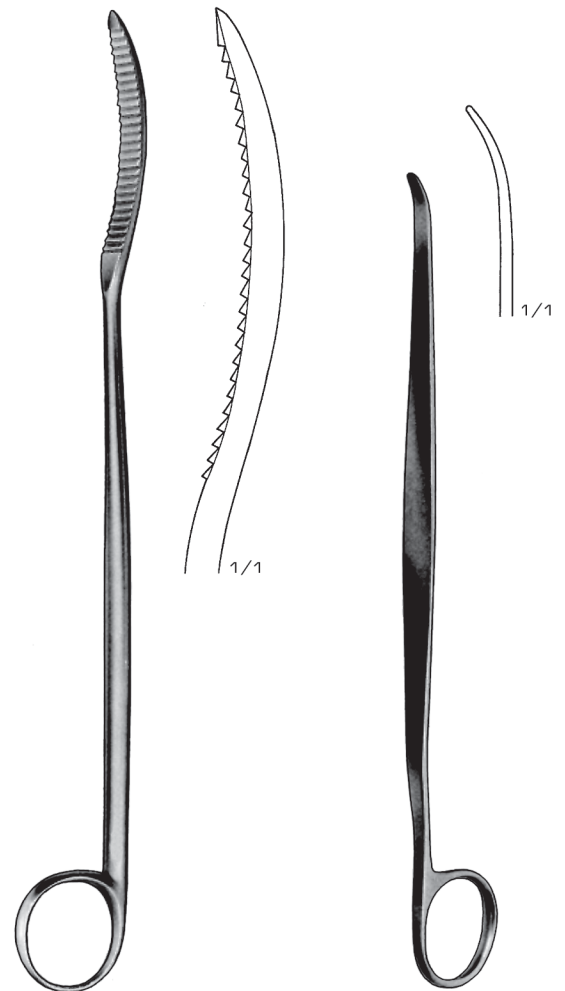

Lane
02-1048-25
25 cm / 10"

Lane-Trethowan
02-1049-215
21.5 cm / 8½"

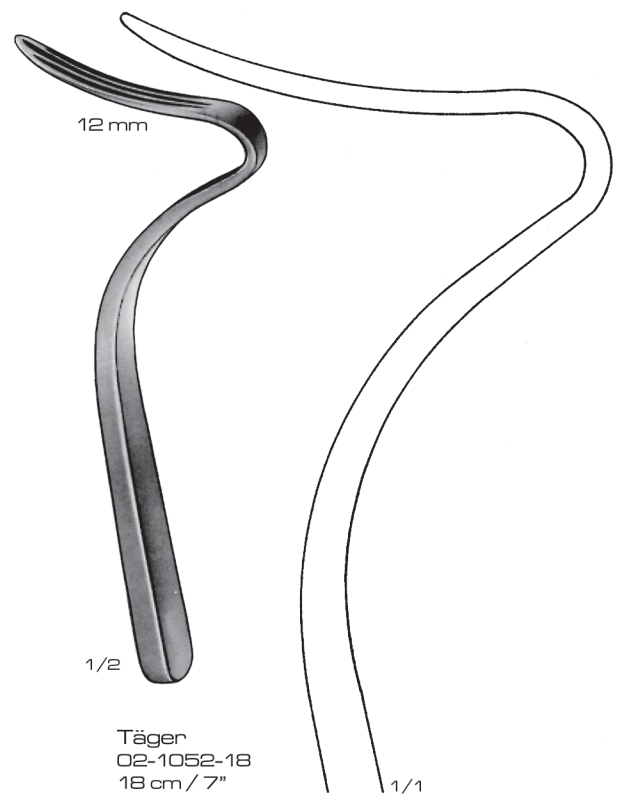

Täger
02-1052-18
18 cm / 7"
Bone lever for angle
joint operations



Hohmann-Aldinger
02-1053-27
27 cm / 10 1/2"

Schumacher Mod. Wagner
02-1054-34
34 cm / 13 1/2"

Murphy-Lane
02-1055-34
34 cm / 13 1/2"
Luxation lever

Wagner
02-1056-33
33 cm / 13"

BONE FILES

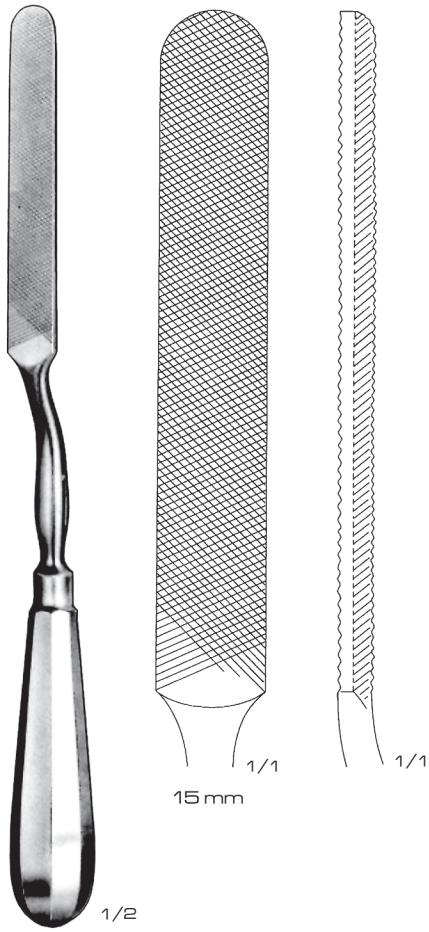

02-1057-245
24.5 cm / 9 3/4"

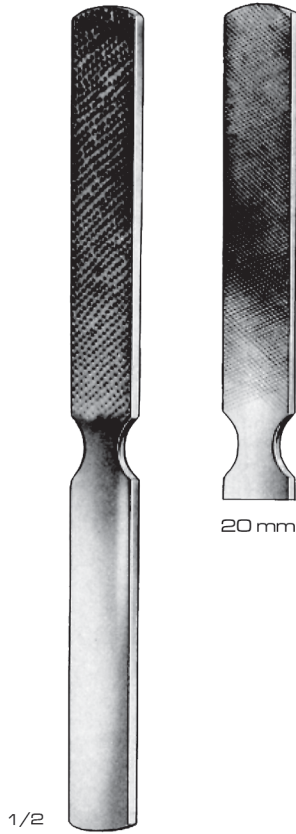

02-1058-22
22 cm / 8 3/4"



02-1059-245
16.5 mm
Flat

02-1060-245
16.5 mm
Semi-circular

02-927-245

Eichler
02-1059-245 & 02-1060-245
24.5 cm / 9 3/4"

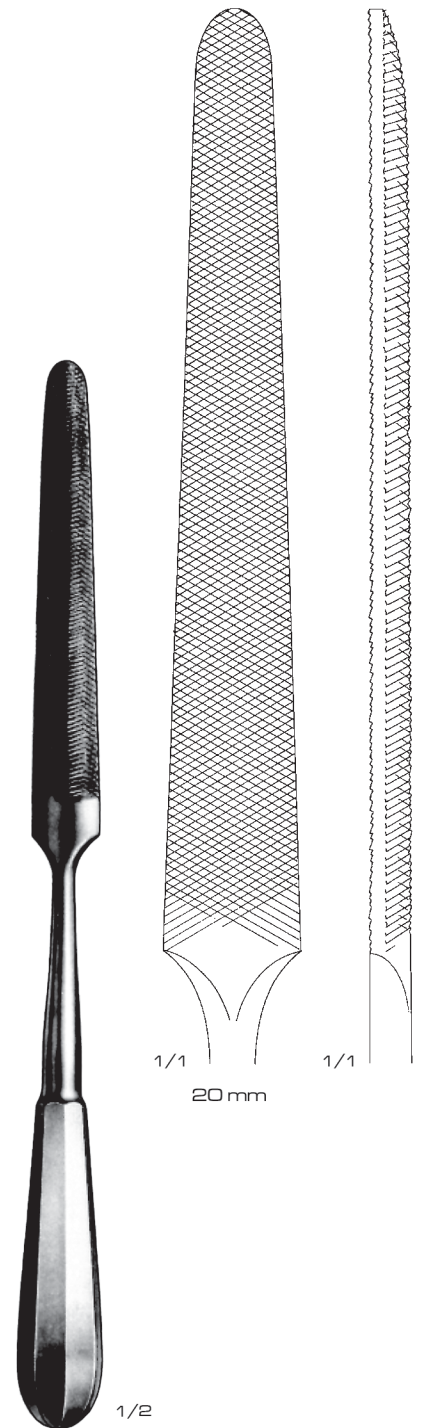

02-1061-28
28 cm / 11"

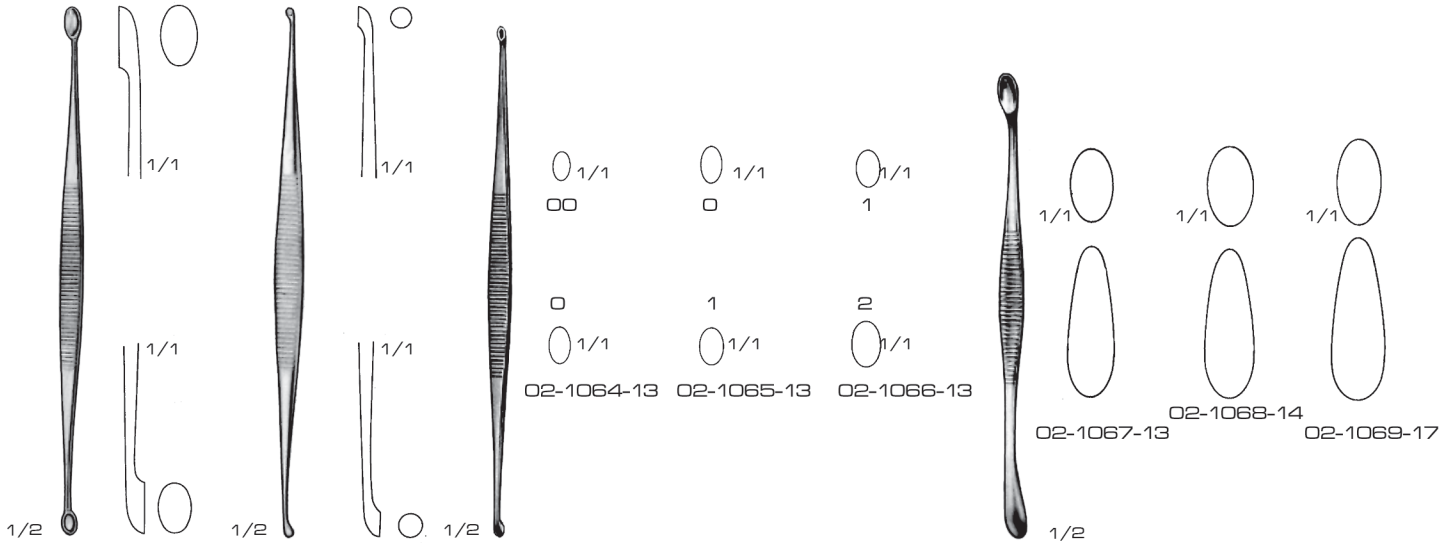

Jacobson
02-1062-14
14 cm / 5 1/2"

Martini
02-1063-14
14 cm / 5 1/2"

Williger
02-1064-135 To 02-1066-135
13.5 cm / 5 1/4"

Volkmann
02-1067-13 13 cm / 5 1/8"
02-1068-14 14 cm / 5 1/2"
02-1069-17 17 cm / 6 3/4"

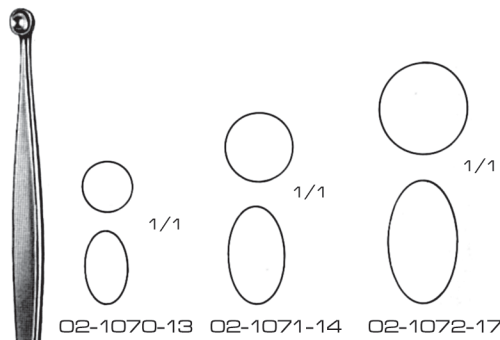

Volkmann
02-1070-13 13 cm / 5 "
02-1071-14 14 cm / 5 1/2"
02-1072-17 17 cm / 6 3/4"

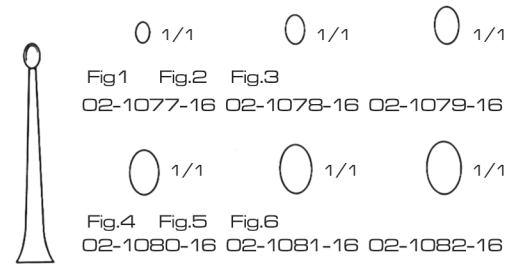

Fig.1 Fig.2 Fig.3
02-1077-16 02-1078-16 02-1079-16

Fig.4 Fig.5 Fig.6
02-1080-16 02-1081-16 02-1082-16

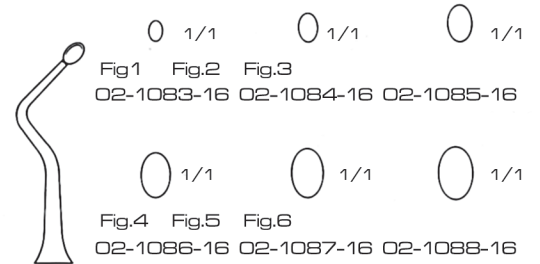

Fig.1 Fig.2 Fig.3
02-1083-16 02-1084-16 02-1085-16

Fig.4 Fig.5 Fig.6
02-1086-16 02-1087-16 02-1088-16

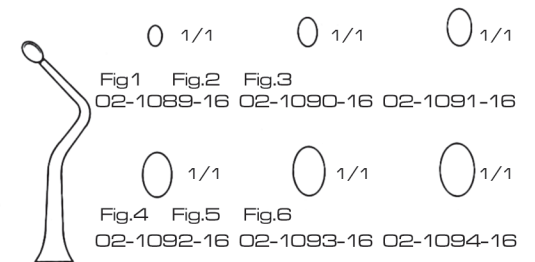
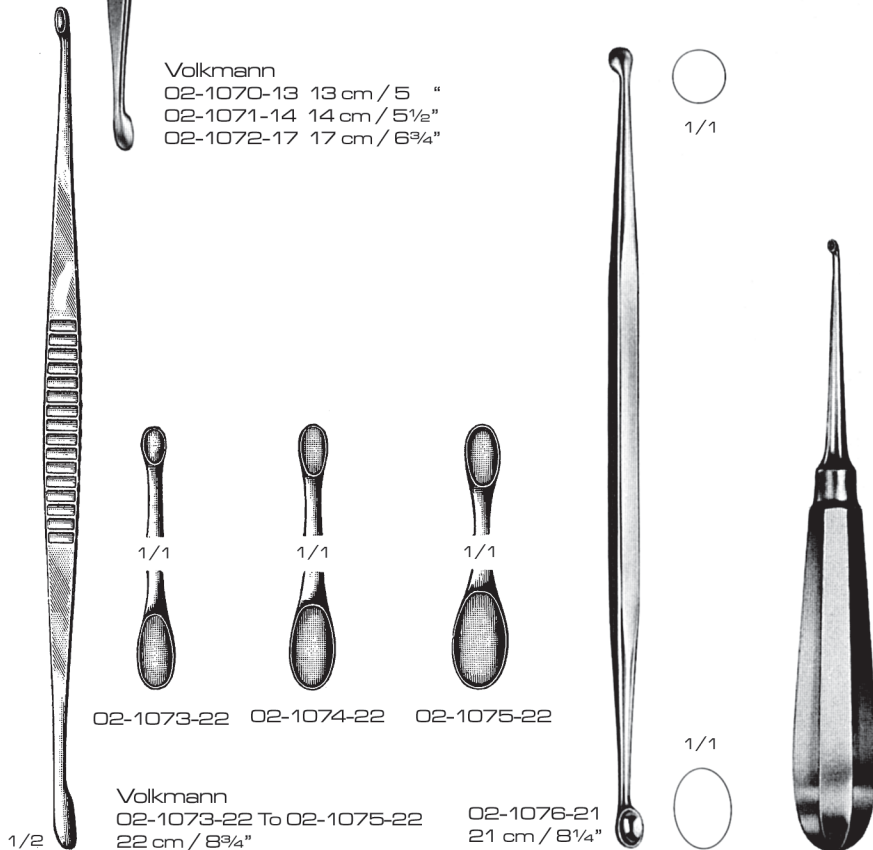

Fig.1 Fig.2 Fig.3
02-1089-16 02-1090-16 02-1091-16

Fig.4 Fig.5 Fig.6
02-1092-16 02-1093-16 02-1094-16



Volkmann
02-1073-22 To 02-1075-22
22 cm / 8 3/4"

02-1076-21
21 cm / 8 1/4"

Mod. USA
02-1077-16 To 02-1094-16
16 cm / 6 1/4"



1/2

○ 1/1
Fig. 0000
02-1095-17

○ 1/1
Fig. 0
02-1098-17

○ 1/1
Fig. 3
02-1101-17

○ 1/1
Fig. 000
02-1096-17

○ 1/1
Fig. 1
02-1099-17

○ 1/1
Fig. 4
02-1102-17

○ 1/1
Fig. 6
02-1104-17

○ 1/1
Fig. 00
02-1097-17

○ 1/1
Fig. 2
02-1100-17

○ 1/1
Fig. 5
02-1103-17



1/2

○ 1/1
Fig. 0000
02-1105-17

○ 1/1
Fig. 0
02-1108-17

○ 1/1
Fig. 3
02-1111-17

○ 1/1
Fig. 000
02-1106-17

○ 1/1
Fig. 1
02-1109-17

○ 1/1
Fig. 4
02-1112-17

○ 1/1
Fig. 6
02-1114-17

○ 1/1
Fig. 00
02-1107-17

○ 1/1
Fig. 2
02-1110-17

○ 1/1
Fig. 5
02-1113-17

Bruns
02-1095-17 To 02-1104-17
17 cm / 6¾"

Spratt
02-1105-17 To 02-1114-17
17 cm / 6¾"



1/2

Halle
02-1115-21 To 02-1117-21
21 cm / 8¼"

○ 1/1
Fig. 01
02-1115-21
02-1118-215

○ 1/1
Fig. 02
02-1116-21
02-1119-215

○ 1/1
Fig. 03
02-1117-21
02-1120-215



1/2

Halle
02-1118-21 To 02-1120-21
21 cm / 8¼"



1/1

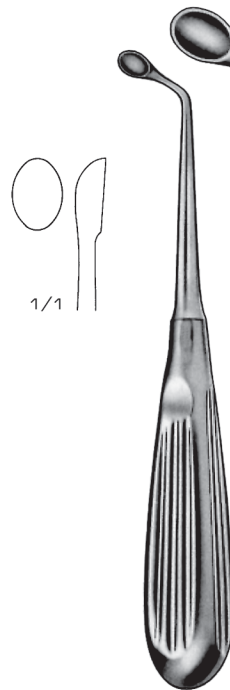

1/2

Uffenorde
02-1121-17
17 cm / 6¾"



1/1



1/1



1/1



1/2

Uffenorde
02-1122-17
17 cm / 6¾"

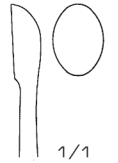

1/1



- 1/1
Fig. 00
02-1123-18
- 1/1
Fig. 0
02-1124-18
- 1/1
Fig. 0
02-1125-18
- 1/1
Fig. 0
02-1126-18
- 1/1
Fig. 1
02-1127-18
- 1/1
Fig. 1
02-1128-18
- 1/1
Fig. 2
02-1129-18
- 1/1
Fig. 2
02-1130-18

Willinger
02-1123-18 To 02-1130-18
18 cm / 7"



- 1/1
Fig. 000
02-1131-17
- 1/1
Fig. 00
02-1132-17
- 1/1
Fig. 0
02-1133-17
- 1/1
Fig. 1
02-1134-17
- 1/1
Fig. 2
02-1135-17
- 1/1
Fig. 3
02-1136-17
- 1/1
Fig. 4
02-1137-17

Schede
02-1131-17 To 02-1137-17
17 cm / 6¾"



- 1/1
Fig. 0000
02-1138-17
- 1/1
Fig. 000
02-1139-17
- 1/1
Fig. 00
02-1140-17
- 1/1
Fig. 00
02-1141-17
- 1/1
Fig. 1
02-1142-17
- 1/1
Fig. 2
02-1143-17
- 1/1
Fig. 3
02-1144-17
- 1/1
Fig. 4
02-1145-17
- 1/1
Fig. 5
02-1146-17
- 1/1
Fig. 6
02-1147-17

Volkman
02-1138-17 To 02-1147-17
17 cm / 6¾"

BONE CURETTES

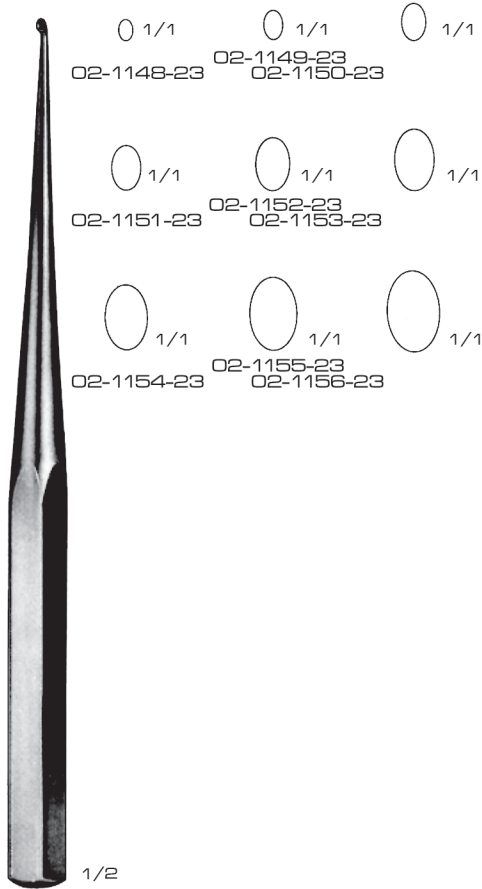

Bruns
02-1148-23 To 02-1156-23
23 cm / 9"



Bruns (Volkmann)
02-1157-21 To 02-1166-21
21 cm / 8 1/4"



Bruns (Volkmann)
02-1167-21 To 02-1176-21
21 cm / 8 1/4"

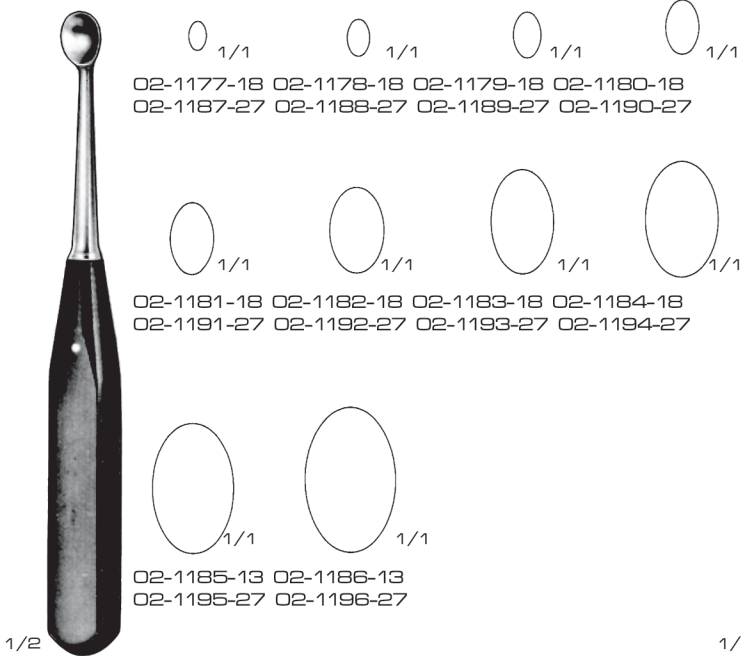

Volkmann
02-1177-18 To 02-1186-18
18 cm / 7"



Volkmann
02-1187-27 To 02-1196-27
27 cm / 10 1/2"



Lampert
02-1197-20 To 02-1204-20
20 cm / 8"



Fig. 000 1/1
02-1205-235

Fig. 00 1/1
02-1206-235

Fig. 0 1/1
02-1207-235

Fig. 1 1/1
02-1208-235

Fig. 2 1/1
02-1209-235

Fig. 3 1/1
02-1210-235

Fig. 4 1/1
02-1211-235

Fig. 5 1/1
02-1212-235

Fig. 6 1/1
02-1213-235

Simon
02-1205-235 To 02-1213-235
23.5 cm / 9 1/4"

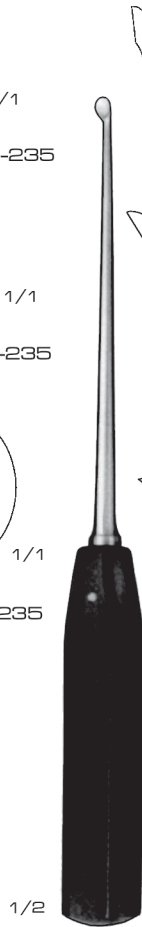

Fig. 000 1/1
02-1214-22

Fig. 00 1/1
02-1215-22

Fig. 0 1/1
02-1216-22

Fig. 000 1/1
02-1217-22

Fig. 00 1/1
02-1218-22

Fig. 0 1/1
02-1219-22

Fig. 000 1/1
02-1220-22

Fig. 00 1/1
02-1221-22

Fig. 0 1/1
02-1222-22

Caspar
02-1214-22 To 02-1222-22
22 cm / 8 3/4"

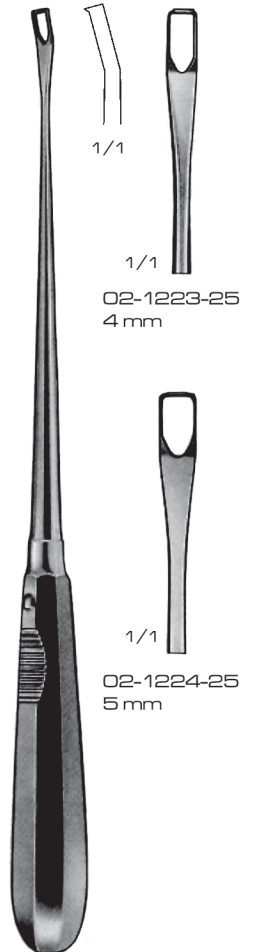

Caspar
02-1223-25 & 02-1224-25
25 cm / 10"



Fig. 000 1/1
02-1225-25

Fig. 00 1/1
02-1226-25

Fig. 0 1/1
02-1227-25

Fig. 1 1/1
02-1228-25

Fig. 000 1/1
02-1229-25

Fig. 00 1/1
02-1230-25

Fig. 0 1/1
02-1231-25

Fig. 1 1/1
02-1232-25

Fig. 000 1/1
02-1233-25

Fig. 00 1/1
02-1234-25

Fig. 0 1/1
02-1235-25

Fig. 1 1/1
02-1236-25

Volkmann
02-1225-25 To 02-1236-25
25 cm / 10"



02-1237-25
3 mm

02-1238-25
4 mm

02-1239-25
5 mm

Busche
02-1237-25 To
02-1239-25
25 cm / 10"



1/1
6 mm

1/1

Volkmann
02-1240-22
22 cm / 8 3/4"

PERCUSSION HAMMERS



1/2

Taylor
02-1241-18 18 cm / 7"
02-1242-20 20 cm / 8"

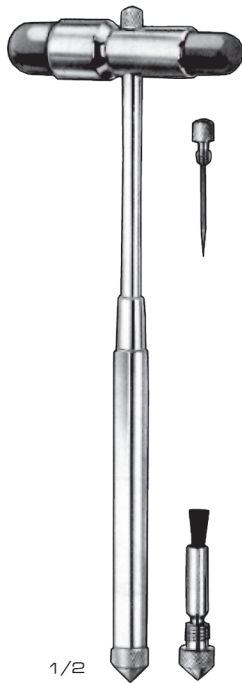

1/2

Buck
02-1243-18 18 cm / 7"
02-1244-20 20 cm / 8"

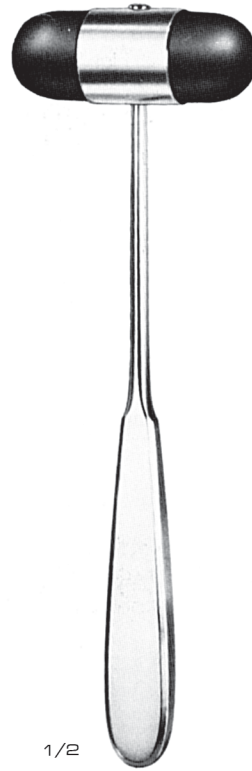

1/2

Dajerine
02-1245-18 18 cm / 7"
02-1246-20 20 cm / 8"

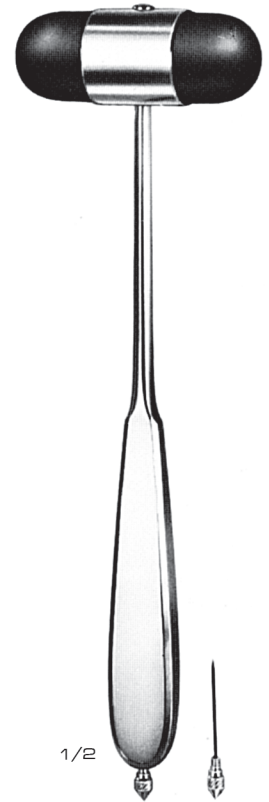

1/2

Dajerine
02-1247-18 18 cm / 7"
02-1248-20 20 cm / 8"

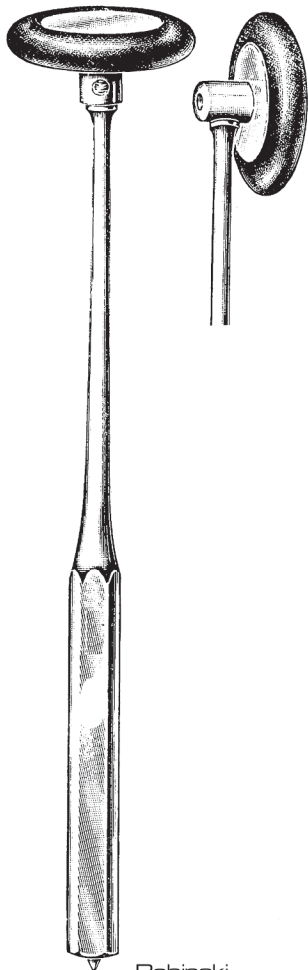

Babinski
02-1249-22
22 cm / 8¾"

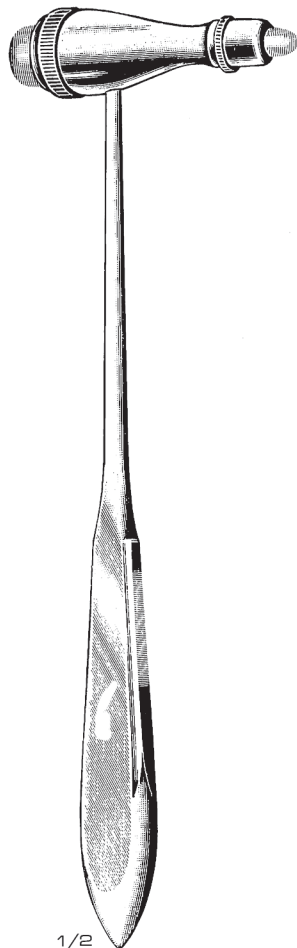

1/2

Troemner
02-1250-245
24.5 cm / 9¾"

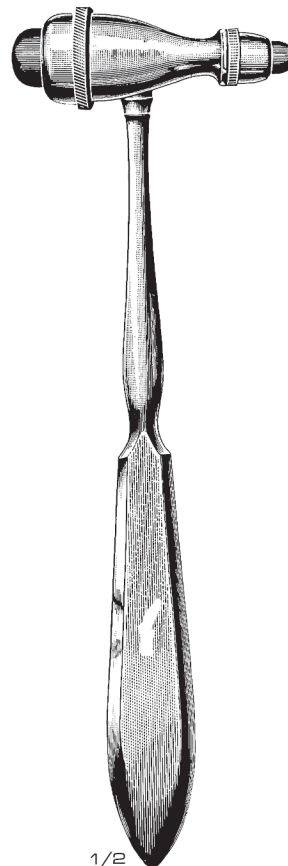

1/2

Troemner
02-1251-24
24 cm / 9½"

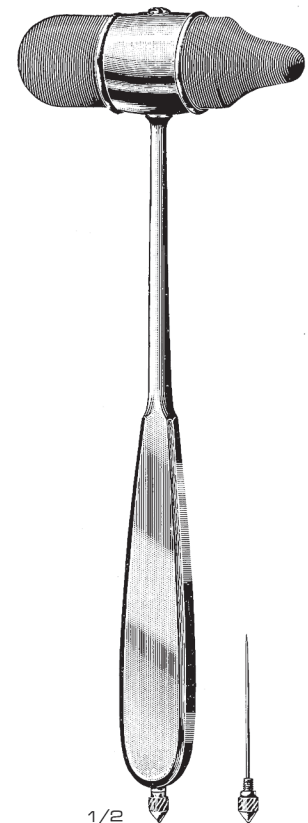

1/2

Neuro-Douflex Mod. Dajerine
02-1252-22
22 cm / 8¾"

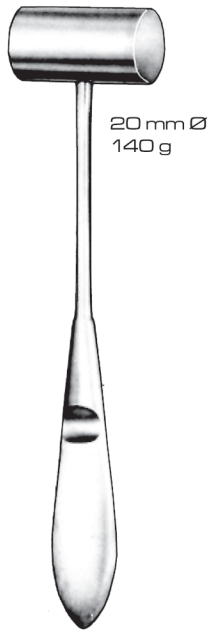

20 mm Ø
140 g

02-1253-165
16.5 cm / 6½"



26 mm Ø
320 g

Mead
02-1254-17
17 cm / 6¾"



Lucae
02-1255-19 & 02-1256-19
19 cm / 7½"

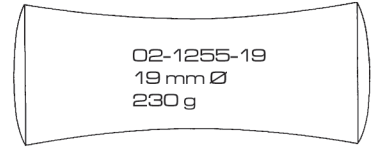

02-1255-19
19 mm Ø
230 g

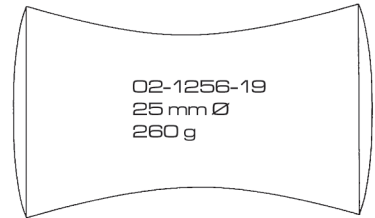

02-1256-19
25 mm Ø
260 g



Doyen
02-1257-21 To 02-1259-21
21 cm / 8¼"

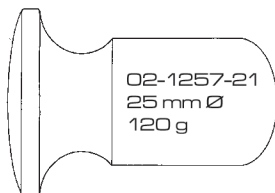

02-1257-21
25 mm Ø
120 g

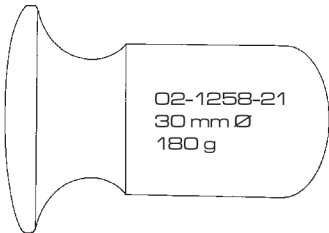

02-1258-21
30 mm Ø
180 g

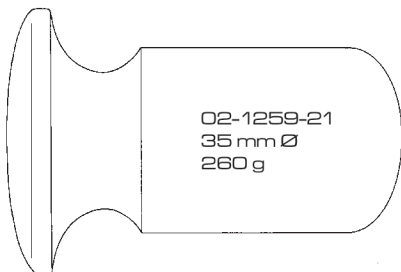

02-1259-21
35 mm Ø
260 g



27 mm Ø
140 g

Hajek
02-1260-215
21.5 cm / 8½"



Williger
02-1261-24 To 02-1263-24
24 cm / 8½"

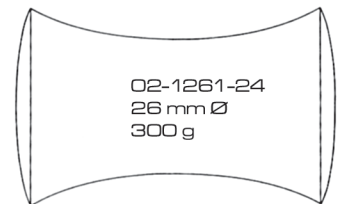

02-1261-24
26 mm Ø
300 g

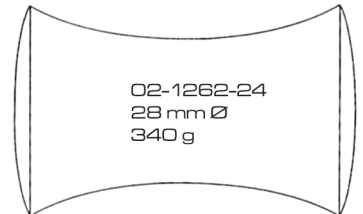

02-1262-24
28 mm Ø
340 g

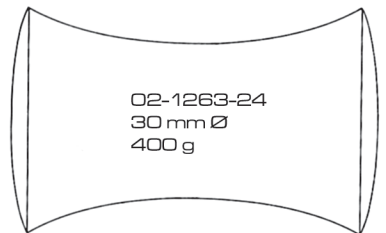

02-1263-24
30 mm Ø
400 g

MALLETS

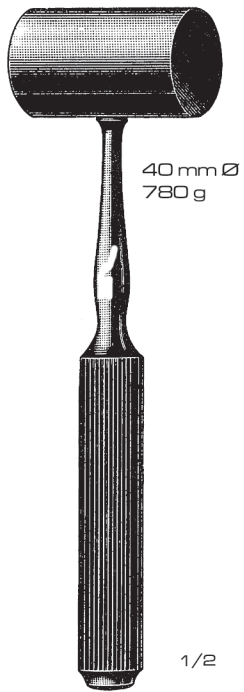

40 mm Ø
780 g

1/2

Omberdanne
02-1264-23
23 cm / 9"

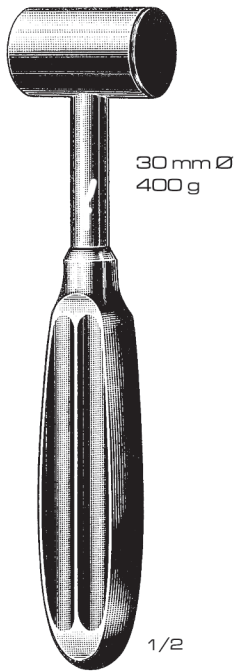

30 mm Ø
400 g

1/2

Gerzog
02-1265-18
18 cm / 7"

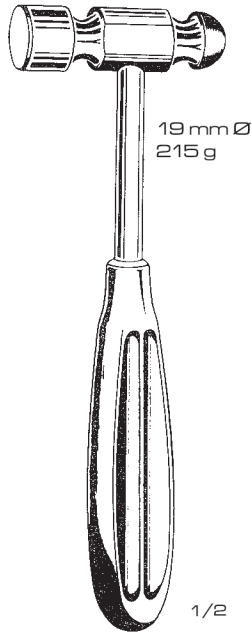

19 mm Ø
215 g

1/2

02-1266-19
19 cm / 7½"

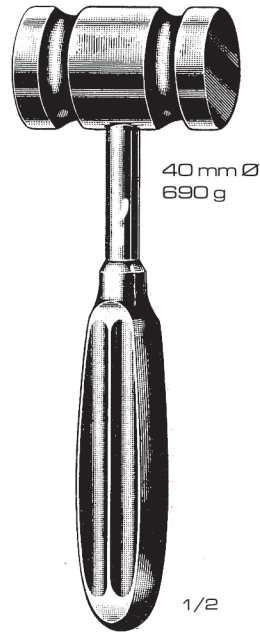

40 mm Ø
690 g

1/2

Kirk
02-1267-195
19.5 cm / 7¾"

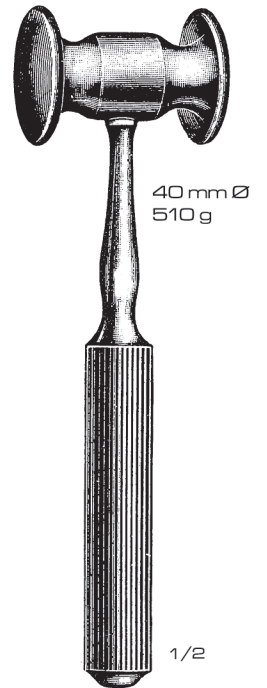

40 mm Ø
510 g

1/2

Bergmann (Hibbs)
02-1268-23
23 cm / 9"



30 mm Ø
240 g
1 Side flat
1 Side convex

1/2

Cottle
02-1269-185
18.5 cm / 7¼"

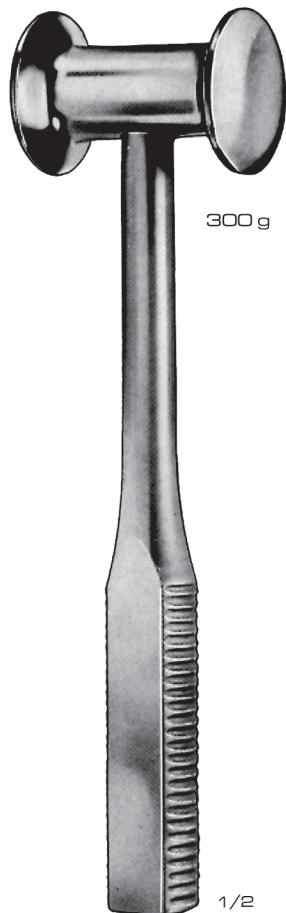

300 g

1/2

Bergmann
02-1270-24
24 cm / 9½"

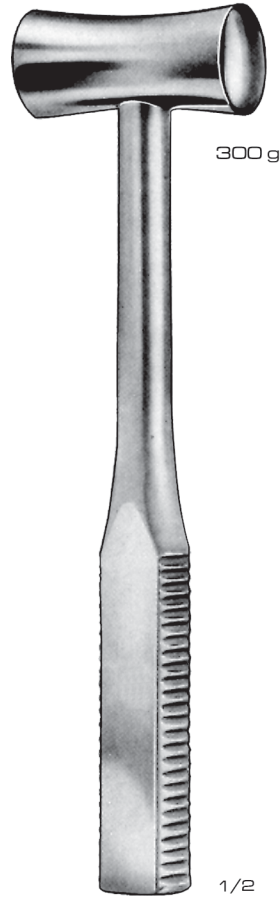

300 g

1/2

Bergmann
02-1271-24
24 cm / 9½"

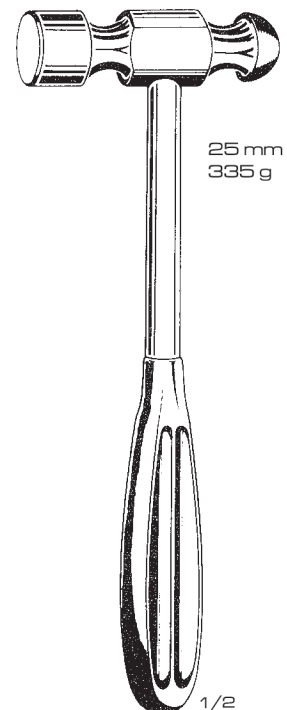

25 mm Ø
335 g

1/2

02-1272-23
23 cm / 9"





02-1273-185
18.5 cm / 7¼"



02-1274-24
24 cm / 9½"

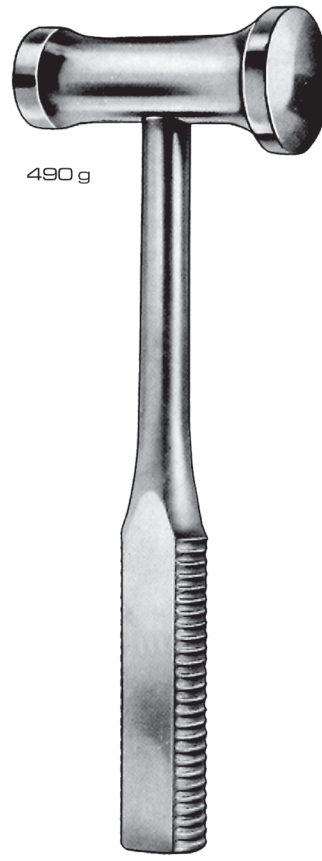

02-1275-24
24 cm / 9½"



02-1276-20
20 cm / 8"

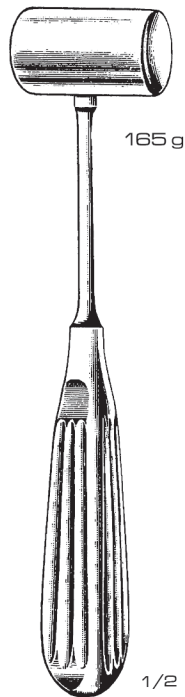

02-1278-19
19 cm / 9½"

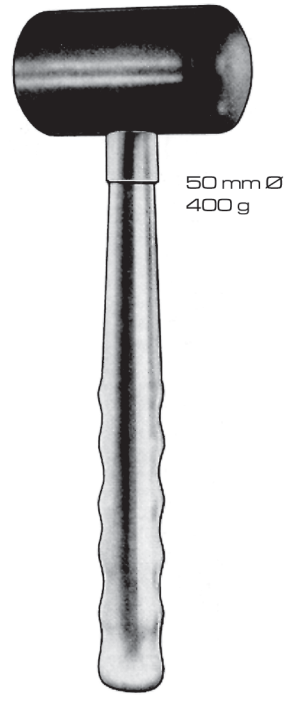

02-1279-26
26 cm / 10¼"
Wooden

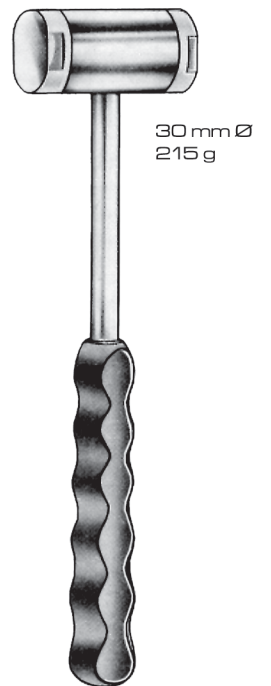

02-1280-24
24 cm / 9½"

MALLETS

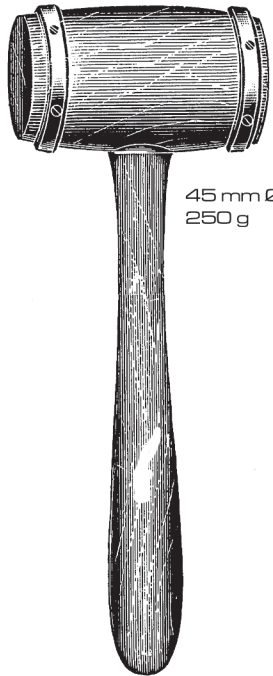

45 mm Ø
250 g

02-1281-23
23 cm / 9"
Wooden

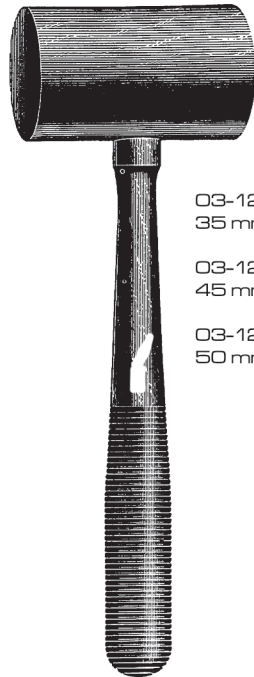

03-1282-26
35 mm Ø, 150 g

03-1283-26
45 mm, Ø 240 g

03-1284-26
50 mm, Ø 330 g

02-1282-26 To 02-1284-26
26 cm / 10 1/4"
Wooden

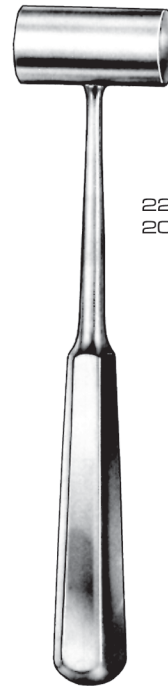

22 mm Ø
200 g

Partsch
02-1285-18
18 cm / 7"



800 g

Heath
02-1286-18
18 cm / 7"



03-1287-23 350 g
03-1288-23 500 g

02-1287-23 & 02-1288-23
23 cm / 9"



02-1289-265
26.5 cm / 10 1/2"
Repercussion free
with fibre handles



30 mm Ø
510 g

02-1290-265
26.5 cm / 10 1/2"
With fibre handles



35 mm Ø
Without disks
130 g

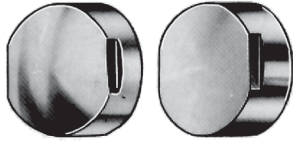

02-1293-235
Spare metal disks
for 02-1291-23 & 02-1292-23
1 metal disk flat
1 metal disk convex

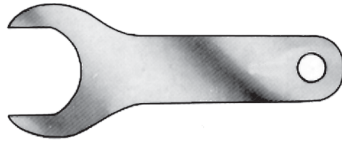

02-1294-235
Wrench

Wagner
02-1291-23
Complete with
1 pair of metal disks
02-1292-23
Complete with
1 Pair of metal disks
1 wrench
23 cm / 9"



42 mm Ø
400 g



42 mm Ø
250 g
400 g



42 mm Ø
530 g

30 mm Ø

02-1297-265
26.5 cm / 10½"
With fibre handles

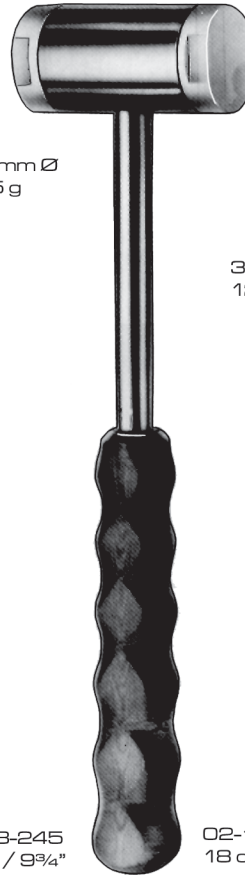

30 mm Ø
215 g

02-1298-245
24.5 cm / 9¾"



30 mm Ø
125 g

02-1299-18
18 cm / 7"

MALLETS

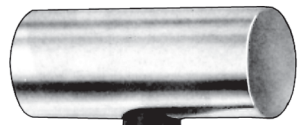

30 mm Ø
480 g



1/2

02-1300-24
24 cm / 9½"

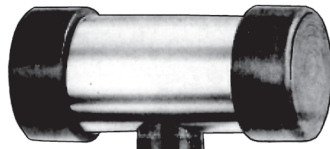

37 mm Ø
370 g



1/2

02-1301-23
23 cm / 9"

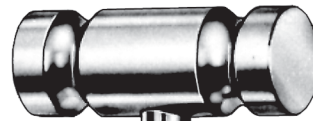

450 g



02-1303-265
26.5 cm / 10½"
With fibre handle

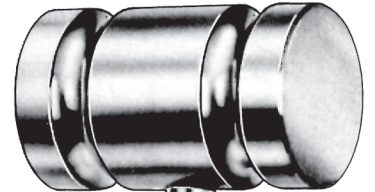

900 g



02-1304-265
26.5 cm / 10½"
With Fibre handle

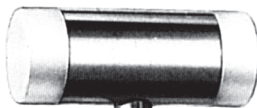

Vickers
02-1302-19
19 cm / 7¾"

INDEX

A

Adson.....02-59
 Alderdyce.....02-60
 Alexander.....02-21, 02-45
 Amputation Saws.....02-3

B

Babinski.....02-73
 Bandage Shears.....02-1, 02-2
 Beeson.....02-2
 Bennet.....02-64
 Bergmann.....02-3, 02-47, 02-75
 Bergmann [Hibbs].....02-75
 Beyer.....02-21, 02-23
 Bircher-Granske.....02-7
 Bishop.....02-42, 02-44
 Blount.....02-61, 02-62
 Blumenthal.....02-22
 Bohler.....02-18, 02-23, 02-32
 Bone Chisels.....02-41 upto 02-51
 Bone Curettes.....02-68 upto 02-72
 Bone Cutting Forceps.....02-16 upto 02-20
 Bone Files.....02-67
 Bone Holding Forceps.....02-5 upto 02-15
 Bone Levers.....02-61 upto 02-66
 Bone Plate Benders.....02-31
 Bone Rongeurs.....02-20 upto 02-27
 Bone Wire Guides.....02-34
 Bone Wire Tightners.....02-34, 02-35
 Bruenings [Lucas].....02-42
 Bruns.....02-2, 02-4, 02-47, 02-69, 02-71
 Bruns [Volkman].....02-71
 Buchs.....02-56
 Buck.....02-73
 Buck-Gramcko.....02-63
 Buckley.....02-42
 Bunnel.....02-29
 Busche.....02-72

C

Casper.....02-52, 02-53, 02-72
 Charriere.....02-3, 02-4
 Cleveland.....02-22
 Cobb.....02-58
 Collin.....02-4
 Commander.....02-1
 Cottle.....02-47, 02-75
 Cushing.....02-30, 02-54, 02-55

D

Dajerine.....02-73
 Dingmann.....02-7
 Doyen.....02-74

E

Echlin.....02-24
 Eichler.....02-67
 Elevators.....02-60
 Extension Bows.....02-32, 02-33

F

Farabeuf.....02-2, 0211, 02-53
 Farabeuf Lambotte.....02-10, 02-11
 Fergusson.....02-8
 Finger Ring Saws.....02-16
 Fracture Pins.....02-32
 Freer.....02-42
 Freidman.....02-20
 Freidman-Vickers.....02-20
 Frosch.....02-9
 Frykholm.....02-24

G

Geiger.....02-24
 Gerzog.....02-75
 Gigli.....02-4
 Gouges.....02-41 upto 02-51

H

Haase.....02-5, 02-52
 Haglund Stille.....02-2
 Halle.....02-69
 Hand Drills.....02-28 upto 02-30
 Hartmann.....02-22
 Heath.....02-77
 Hennig.....02-3
 Hey-Groves.....02-14
 Hibbs.....02-43
 Hip Nailing Instrument.....02-34
 Hoer.....02-54
 Hohmann.....02-62, 02-63
 Hohmann Aldinger.....02-66
 Hoke.....02-42
 Horsley.....02-17
 Hudson.....02-30

J

Jacobson.....02-68
 Jansen.....02-21, 02-59
 Jewett.....02-31

K

Kahre-Williger.....02-54
 Kazanjian.....02-17
 Kern.....02-9
 Kern-Lane.....02-9
 Kern-Mini.....02-9
 Key.....02-59
 Kirk.....02-75
 Kirschner.....02-32, 02-33
 Kleinert-Kutz.....02-24
 Koenig.....02-55
 Kramer.....02-56
 Kuntscher.....02-33

L

Lambotte.....02-11, 02-12, 02-45, 02-49, 02-53, 02-61
 Lampert.....02-22, 02-71
 Lane.....02-10, 02-31, 02-34, 02-65
 Lane-Trethowan.....02-65
 Lange.....02-61
 Lange-Baby.....02-61
 Lange-Hohmann.....02-63, 02-64
 Langenbeck.....02-4, 02-8, 02-55, 02-60
 Lead Hand.....02-14
 Leksell.....02-25
 Lewin.....02-5
 Lexer.....02-49, 02-50
 Lindermann.....02-4
 Lister.....02-14
 Liston.....02-17
 Liston-Key-Horsley.....02-20
 Liston-Stille.....02-19
 Littauer-Liston.....02-17
 Lloyd.....02-34
 Loute.....02-34
 Lowmann.....02-15
 Lowmann-Hoglund.....02-15
 Lucae.....02-74
 Luer.....02-20, 02-21

M

Mallets.....02-71, 02-79
 Markwalder.....02-17
 Marquardt.....02-23
 Martini.....02-68
 Mayfield.....02-23, 02-25
 McDonald.....02-60
 McEwen.....02-46
 McIndoe.....02-19
 Meyer.....02-6
 Mini-Friedman.....02-20
 Mini-Hohmann.....02-62
 Mini-Lambotte.....02-48
 Mini-Lexer.....02-50
 Moore.....02-29
 Muhling.....02-53
 Murphy.....02-45

N

Nail Holders.....02-16
 Neuro-Douflex Mod. Dajerine.....02-73

O

Obwegesser.....02-59
 Olivecrona.....02-4, 02-22, 02-53
 Omberdanne.....02-5
 Osteotomes.....02-41 upto 02-51
 Ricard.....03-17
 Richardson.....03-56
 Richardson-Eastmann.....03-57
 Robin-Masse.....03-18
 Rochard.....03-21
 Rose.....03-29, 03-72
 Roux.....03-71
 Rowe.....03-52
 Rugby.....03-5

P

Palmer.....02-32
 Parham.....02-34
 Partsch.....02-41, 02-55, 02-77
 Partsch Mod. Lange.....02-55
 Passow.....02-52
 Peiper-Beyer.....02-27
 Percussion Hammers.....02-73
 Percy.....02-15
 Percy Retractors.....02-15
 Perman.....02-7
 Perthes.....02-30
 Philips.....02-31
 Plaster Breakers.....02-2
 Plaster Shears.....02-1
 Plaster Spreaders.....02-2, 02-3

Q

Quatro.....02-3
 Quervain.....02-60

R

Ralk.....02-29
 Raspatories.....02-53, 02-59
 Reamers.....02-30
 Reil.....02-6, 02-38
 Rongeurs.....02-20 upto 02-27
 Rottgen-Ruskin.....02-23
 Ruskin.....02-23
 Ruskin-Liston.....02-18
 Ruskin-Mini.....02-23
 Ruskin-Rowland.....02-18

S

Sauerbruch-Coryuos.....02-27
 Sauerbruch-Stille.....02-27
 Schede.....02-70
 Schneider.....02-56
 Schneider-Sauerbruch.....02-56
 Schumacher.....02-65
 Schumacher Mod. Wagner.....02-66
 Schwartz.....02-32
 Screw Drivers.....02-31
 Screw Holders.....02-34
 Sedillot.....02-55
 Semb.....02-8, 02-20, 02-24, 02-56
 Setterlee.....02-3
 Seutin.....02-1
 Sheehan.....02-44
 Simon.....02-72
 Smith-Petersen.....02-25, 02-48
 Spratt.....02-69
 Stamm.....02-17
 Stellbrink.....02-20
 Steinhauer.....02-5
 Stienmann.....02-28, 02-33
 Stille.....02-1, 02-25, 02-28, 02-46
 Stille-Leksell.....02-24
 Stille-Liston.....02-19
 Stille-Luer.....02-26
 Stille-Ruskin.....02-26

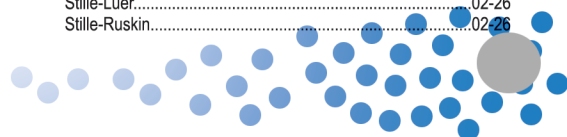

Stille-Sherman.....02-28
 Sypert.....02-26, 02-52

T

Tager.....02-65
 Tampers.....02-52
 Taylor.....02-61, 02-63
 Telescopic.....02-76
 Trelat.....02-55
 Troemner.....02-73
 Tuffier.....02-11

U

Uffenorde.....02-69
 Ulrich.....02-12
 U.S. Army.....02-45

V

Van Buren.....02-8
 Verbrugge.....02-13
 Vickers.....02-60, 02-79
 Volkmann.....02-68, 02-70 upto 02-72

W

Wagner.....02-51, 02-57, 02-63, 02-66, 02-78
 Walton.....02-2
 Weiss.....02-3
 West.....02-42
 Wigmore.....02-3
 Wilberg.....02-32
 Williger.....02-54, 02-59, 02-68, 02-70, 02-74
 Wire Cutting Pliers.....02-38 upto 02-40
 Wire Holding Forceps.....02-37
 Wire Holding Pliers.....02-37
 Wire Pins.....02-33

Z

Zaufal-Jansen.....02-24
 Zielke.....02-51



NANOTECH

TECHNOLOGY | PERCISION | SATISTACTION

NANOTECH
Toor Abad, Daska Road,
Sialkot - Pakistan
Tel / Fax: +92-52-3251119
email: info@nanotech.com.pk nanotech1100@gmail.com
web: www.nanotech.com.pk